

APPENDICES TO ANNEX XV RESTRICTION REPORT

**SUBSTANCE NAME(S): Per- and polyfluoroalkyl substances (PFASs)
in firefighting foams**

CONTACT DETAILS OF THE DOSSIER SUBMITTER:

European Chemicals Agency (ECHA)

Telakkakatu 6, PO BOX 400, FI-00121, Helsinki, Finland

VERSION NUMBER: 2.0

DATE: 23 March 2022

CONTENTS

Appendix 1. Stakeholders survey on techniques to clean equipment	1
1.1. “Non cleaning”.....	1
1.1.1. Background	1
1.1.2. Replacement Procedure.....	1
1.1.3. Remaining PFAS concentrations.....	1
1.1.4. Costs.....	1
1.1.5. Additional information and available case studies	1
1.2. Cleaning procedure by BIOEX	2
1.2.1. Background	2
1.2.2. Cleaning Procedure.....	2
1.2.3. Remaining PFAS concentrations.....	2
1.2.4. Costs.....	2
1.2.5. Additional information and available case studies	2
1.3. V171 by Arcadis.....	3
1.3.1. Background	3
1.3.2. Cleaning Procedure.....	3
1.3.3. Remaining PFAS concentrations.....	4
1.3.4. Costs.....	4
1.3.5. Additional information and available case studies	4
1.4. Cleaning procedure with PerfluorAd® by Cornelsen.....	5
1.4.1. Background	5
1.4.2. Cleaning Procedure.....	5
1.4.3. Remaining PFAS concentrations.....	6
1.4.4. Costs.....	7
1.4.5. Additional information and available case studies	7
1.5. Cleaning protocol by the Bavarian State Ministry for the Environment and Consumer Protection (LfU).....	8
1.5.1. Background	8
1.5.2. Cleaning Procedure.....	8

ANNEX XV RESTRICTION REPORT – PFAS IN FIREFIGHTING FOAMS

1.5.3. Remaining PFAS concentrations.....	9
1.5.4. Costs.....	9
1.5.5. Additional information and available case studies	9
1.6. Cleaning protocol by Fire Rescue Victoria (FRV) - Appliance PFAS Decontamination Project.....	9
1.6.1. Background	10
1.6.2. Cleaning Procedure.....	10
1.6.3. Remaining PFAS concentrations.....	12
1.6.4. Costs.....	13
1.6.5. Additional information and available case studies	13
1.7. Cleaning protocol by FPA Australia.....	13
1.7.1. Background	13
1.7.2. Cleaning Procedure.....	13
1.7.3. Remaining PFAS concentrations.....	14
1.7.4. Costs.....	14
1.7.5. Additional information and available case studies	14
1.8. Cleaning protocol by the Australian DoD.....	14
1.8.1. Background	14
1.8.2. Cleaning Procedure.....	15
1.8.3. Remaining PFAS concentrations.....	16
1.8.4. Costs.....	16
1.8.5. Additional information and available case studies	16
1.9. Cleaning protocol by the German industrial plants fire brigades association (Werkfeuerwehrverband Deutschland - WFVD)	16
1.9.1. Background	16
1.9.2. Cleaning Procedure.....	17
1.9.3. Remaining PFAS concentrations.....	17
1.9.4. Costs.....	18
1.9.5. Additional information and available case studies	19
Appendix 2. Techniques for disposal of firefighting foam concentrates.....	20
2.1. Physical destruction – Incineration in Hazardous Waste Incineration plants	21

ANNEX XV RESTRICTION REPORT – PFAS IN FIREFIGHTING FOAMS

2.2. Physical destruction – Incineration in cement kilns.....	26
2.3. Conclusion on the disposal techniques for PFAS-containing firefighting foam concentrates.....	29
Appendix 3. Disposal of PFAS-contaminated fire run off and equipment cleaning water.....	31
3.1. Background.....	31
3.2. Non-destructive method: Granular activated carbon (GAC) treatment.....	35
3.3. Non-destructive method: Ion exchange (IX)	38
3.4. Non-destructive method: Precipitation - PerfluorAd®	40
3.5. Non-destructive method: foam fractionation and ozofractionation	44
3.6. Destructive approaches: incineration	47
3.7. Conclusion on the disposal techniques of PFAS-contaminated fire run off and equipment cleaning water.....	47
Appendix 4. Detailed foam transition timescales (from industry) (source: Wood 2020)	49
Appendix 5. List of international standards for firefighting foam performance (from Wood et al. 2020).....	55
Appendix 6. List of alternative firefighting foam products available on the EU market, as identified by Wood et al. 2020 in the consultation responses.....	62
Appendix 7. RO 4: description of the derogation mechanism as suggested by Eurofeu.....	67
7.1. Description of the process to grant a permit for use of fluorine containing firefighting foam agents	67
7.2. Benefits.....	67
Appendix 8. Details of the calculations used in the emissions model and results obtained .	69
8.1. Calculation descriptions	69
8.1.1. Simulation of the baseline scenario	69
8.1.2. Formulation of the firefighting foam concentrate	70
8.1.3. Stock.....	71
8.1.4. Use phase – incidents and training.....	74
8.1.5. Waste treatment	75
8.1.6. Emissions to soil, surface water, air and sea.....	77
8.2. RO1: Ban on the placing on the market, use allowed.....	77
8.2.1. RMMs for training, testing and incidents.....	78
8.3. RO2: Ban on the placing on the market and use.....	79

ANNEX XV RESTRICTION REPORT – PFAS IN FIREFIGHTING FOAMS

8.4. RO3: same as RO2 but considering emissions from the formulation for export	79
8.5. RO4: same as RO2 but with progressive decline of oil/chemical and defence uses .	80
8.6. RO5: uses banned unless releases fully contained and adequately treated.....	80
8.7. Emissions results	81
8.7.1. Baseline scenario	81
8.7.2. RO1: Ban on the placing on the market	81
8.7.2.1. Emission patterns	81
8.7.2.2. Sensitivity analysis	86
Scenario with risk management measures.....	86
Scenario without risk management measures	88
8.7.3. RO2: Ban on the placing on the market and use	91
8.7.3.1. Emission patterns	91
8.7.3.2. Sensitivity analysis	93
8.7.4. RO 3: Ban on the placing on the market, use and export.....	95
8.7.4.1. Emission patterns	95
8.7.4.2. Sensitivity analysis	96
8.8. RO 4: Ban on the placing on the market and use, with permit system for Seveso and defense sites	98
8.8.1. Emission patterns.....	98
8.8.2. Sensitivity analysis	102
8.9. RO 5: Ban on the placing on the market and use, unless full containment in place	104
8.9.1. Emission pattern	104
8.9.2. Sensitivity analysis	105
8.10. Cumulative emissions per use/sector under the five ROs.....	107
8.10.1. Cumulative emissions for the five ROs with RMMs	107
8.10.2. Cumulative emissions for the five ROs without RMMs	108
Appendix 9. Sensitivity calculations for and time profile of costs.....	110
9.1. RO1: Ban on the placing on the market, use allowed.....	110
Sensitivity analysis	110
9.2. RO2: Ban on the placing on the market and use	116
Sensitivity analysis	116
9.3. RO3: same as RO2 but considering ban on exports	121

ANNEX XV RESTRICTION REPORT – PFAS IN FIREFIGHTING FOAMS

Sensitivity analysis	121
9.4. RO 4: Ban on the placing on the market and use, with permit system for Seveso and defence sites	121
Sensitivity analysis	121
9.5. RO 5: Ban on the placing on the market and use, unless full containment in place	123
Sensitivity analysis	123
Appendix 10. Measured levels in environmental compartments	126
10.1. Introduction	126
10.2. Distribution and mobility in water and soil	126
10.2.1. Occurrence of PFASs in Groundwater, freshwater and marine water	127
10.2.2. Suspended particulate matter.....	141
10.2.3. Occurrence of PFASs in Soil.....	142
10.2.4. Ambient concentrations in soil	147
10.2.5. Contaminated sites	147
10.2.6. Soil as a global reservoir.....	150
10.2.7. Drinking water concentrations	150
10.2.8. Conclusion.....	159
10.3. Sewage treatment plant.....	159
10.3.1. Wastewater influents and effluents.....	159
10.3.2. Sewage sludge	201
10.4. Concentrations in biota	207
10.5. Concentrations in plants.....	211
10.6. Measured levels indicating potential for lon-range transport	217
10.6.1. Air/atmosphere	221
10.6.2. Water	223
10.6.3. Freshwater	226
10.6.4. Snow and ice	226
10.6.5. Biota	228
10.6.6. Screening of PFASs in Nordic countries and the Arctic	233
10.6.7. Conclusion.....	234
10.7. Time trends.....	235

ANNEX XV RESTRICTION REPORT – PFAS IN FIREFIGHTING FOAMS

10.8. Monitoring data on specific PFAS groups	240
10.8.1. SC-PFCAs, SC-PFSAs and C7-PFCA	240
10.8.2. Cyclic PFAAs	241
10.8.3. Ultra-short (C2-C3) PFCAs and PFSAs	242
10.8.4. PFPAs	243
10.8.5. PFECAs and PFESAs	243
References	245

TABLES

Table 1. PFAS residual thresholds (taken from (Fire-Rescue-Victoria, 2021)).....	13
Table 2. Comparison between incineration techniques for PFAS-based firefighting foams in hazardous waste incinerators (HWI) and cement kilns	30
Table 3. Interdependence between annual usage rate and corresponding stock assumed..	73
Table 4. Sensitivity analysis of avoided PFAS emissions compared to the baseline (best estimates) for RO1 varying one input parameter at the time, compared to the baseline scenario best estimate	86
Table 5. Sensitivity analysis of avoided PFAS emissions compared to the baseline (best estimates) for RO1 varying one input parameter at the time, compared to the baseline scenario best estimate	88
Table 6. Sensitivity analysis of avoided PFAS emissions compared to the baseline (best estimates) for RO2 with RMM varying one input parameter at the time.....	94
Table 7. Sensitivity analysis for RO3 assuming continued export: avoided PFAS emissions compared to the baseline (best estimates) varying one input parameter at the time ..	97
Table 8. Sensitivity analysis of avoided PFAS emissions compared to the baseline (best estimates) for RO4 with RMM varying one input parameter at the time.....	103
Table 9. Sensitivity analysis of avoided PFAS emissions compared to the baseline (best estimates) for RO5 with RMM varying one input parameter at the time.....	106
Table 10. cumulative emissions of PFASs over 30 years under the BEST scenario for the five ROs with RMMs	107
Table 11. cumulative emissions of PFASs over 30 years under the LOW scenario for the five ROs with RMMs	107
Table 12. cumulative emissions of PFASs over 30 years under the HIGH scenario for the five ROs with RMMs	108
Table 13. cumulative emissions of PFASs over 30 years under the BEST scenario for the five ROs without RMMs.....	108

ANNEX XV RESTRICTION REPORT – PFAS IN FIREFIGHTING FOAMS

Table 14. Cumulative emissions of PFASs over 30 years under the LOW scenario for the five ROs without RMMs.....	108
Table 15. Cumulative emissions of PFASs over 30 years under the HIGH scenario for the five ROs without RMMs.....	109
Table 16: Sensitivity analysis of costs (net present values) for RO1 (ban on the placing on the market, with low, best and high estimates) with RMM.	111
Table 17: Sensitivity analysis of costs (net present values) for RO2 (ban on the placing on the market, with low, best and high estimates) with RMM.	117
Table 18: Sensitivity analysis of costs (net present values) for RO5 (ban on the placing on the market, with low, best and high estimates) with RMM.	124
Table 19. Collection* of PFAS levels of PFASs detected in groundwater.	128
Table 20. Collection of the levels detected in surface waters.	132
Table 21. Collection of the levels detected in soil.	143
Table 22. Collection* of the PFAS levels detected in drinking water/tap water and bottled drinking water.	151
Table 23. Collection of the levels detected in wastewater influents.....	161
Table 24. Collection of the levels detected in wastewater effluents.	183
Table 25. Collection of the levels detected in sewage sludge.	201
Table 26. Concentrations of PFASs in different plants species taken from contaminated sites (reviewed by Li et al. 2022)	213
Table 27. Collection of the levels detected in different matrices and biota in remote areas.	218

FIGURES

Figure 1. Sum of PFAS concentrations during decontamination of AFFF-Impacted sewer system and of a 20-m ³ concentrate tank.	4
Figure 2. Schematic overview on the three individual steps of the cleaning procedure are shown schematically. The cleaning of stationary equipment is shown at the left and the cleaning of fire brigade machines is shown at the right (no illustration available for the first step).	6
Figure 3. Results of the Cleaning of Fire Trucks using PerfluorAd.	7
Figure 4. The Decontamination Process – in pictures (taken from ((Fire-Rescue-Victoria, 2021))).	11
Figure 5. Achieved PFAS levels after decontamination according to the protocol by FVR, before (blue) and after (red) (taken from (Fire-Rescue-Victoria, 2021)).	12
Figure 6. Overview on the Aircraft Rescue & Firefighting (ARFF) foam transition project (DoD-AUS, 2020a)	15

ANNEX XV RESTRICTION REPORT – PFAS IN FIREFIGHTING FOAMS

Figure 7. Cleaning procedure phases in accordance to the Queensland DoD (DoD-AUS, 2020c).....	16
Figure 8. PFAS Analysis of rinsing water from apparatus "TMB" from step 4 of tank cleaning procedure (note, that the detection limit is lower as this is an analysis for PFASs in water as opposed to PFASs in foam concentrate in other figures)	18
Figure 9. PFAS Analysis of rinsing water from apparatus "PTLF II" from step 4 of tank cleaning procedure (Note 1: The detection limit is lower as this is an analysis for PFASs in water as opposed to PFASs in foam concentrate in other figures. Note 2: This apparatus is also referred to as "TroTSLF 2" or "PTLF 2")	18
Figure 10. Estimated costs for the cleaning of a 1 m ³ foam concentrate tank with the described cleaning procedure	19
Figure 11. The hazardous waste incinerator process taken from Eurits homepage.....	23
Figure 12. Availability of HWI across the EU taken from Eurits homepage.....	25
Figure 13. PFAS treatment technologies for water, ranged according to their practicality (taken from (UBA, 2020), green box added).....	32
Figure 14. Conceptual impact of volume on the relevance of currently available non-destructive and destructive treatment approaches for PFAS contaminated water (taken from (Horst et al., 2020))	32
Figure 15. Outline of the entry of firefighting water into the subsurface if no retention facilities are available taken from (Cornelsen, 2021).....	34
Figure 16. On the left, a representation of a soil excavation after successful infiltration of extinguishing water into the subsoil. On the right the pump and treat procedure is shown (Cornelsen, 2021).....	34
Figure 17. PFAS flow diagram for adsorption filtration with IEX /taken from (Concawe, 2020)).....	39
Figure 18. Schematic overview of an Activated Carbon Plant (GAC) with PerfluorAd Pre-treatment Stage (taken from Cornelsen).....	41
Figure 19. The interaction between the PFAS molecule (below shown for the example of 6:2 FTS) and the added cation (taken from Maga et al 2021)	42
Figure 20. Elimination rates for different parameters [%] at an optimal dosing rate of 2.0 g/l PerfluorAd applied on a 1% AFFF premix (taken from (Cornelsen 2021))	42
Figure 21. Illustrative Concept of foam fractionation (taken from (UBA, 2020))	44
Figure 22. Ozofractionation process concept (taken from (UBA, 2020)).	45
Figure 23. Material flow diagram showing the connection between the different life cycles stages formulation, in-use, stock and waste treatment for PFASs in firefighting foams in the baseline scenario.	69
Figure 24. Material flow diagram for the formulation phase.....	71
Figure 25. Material flow diagram for the for the life cycle stage Stock	72

ANNEX XV RESTRICTION REPORT – PFAS IN FIREFIGHTING FOAMS

Figure 26. Material flow diagram for the life cycle stages training and incidents under the baseline scenario.....	74
Figure 27. Material flow diagram for the waste treatment phase under the baseline scenario.	76
Figure 28. Material flow diagram for the life cycle stages training and incidents, including RMMs as foreseen in the ROs.	79
Figure 29. Cumulative emission to soil, air and surface water (t PFASs) with and without RMM for chemical / petrochemical Seveso ("Best scenario").....	82
Figure 30. Cumulative emission to soil, air and surface water (t PFASs) with and without RMM for training and testing ("Best scenario").	84
Figure 31. Total yearly emission (t PFASs) with and without RMM for chemical Seveso incidents and training and testing ("Best" estimate scenario).	85
Figure 32. Cumulative emission to soil, air and surface water (t PFASs) with and without RMM for chemical / petrochemical Seveso incidents ("Best scenario").	92
Figure 33. Total yearly emissions (t PFASs) with and without RMM for chemical Seveso incidents and training and testing (RO2, "Best" estimate scenario).	93
Figure 34. Cumulative total emission (t PFASs) for scenario RO3 with and without RMM (all sectors, "Best" estimate scenario), considering continued export after the transitional periods.	96
Figure 35. Total yearly emission (t PFASs) with and without RMM for chemical Seveso and military incidents (RO4, "Best" estimate scenario).....	99
Figure 36. Cumulative emissions by environmental compartments for the chemical/petrochemical Seveso sector, with and without RMMs (RO4, "Best" estimate scenario).....	100
Figure 37. Cumulative emissions by environmental compartments for the defence sector, with and without RMMs (RO4, "Best" estimate scenario)	101
Figure 38. cumulative emissions for Seveso sector to soil, water and air under RO5 with and without RMMs.	105
Figure 39: Cumulative costs of each cost category for scenario RO1 (all sectors, "Best" estimate scenario, without discounting).	115
Figure 40: Cumulative costs of each cost category for scenario RO2 (all sectors, "Best" estimate scenario, without discounting).	120
Figure 41: Cumulative costs of each cost category for scenario RO4 (all sectors, "Best" estimate scenario, without discounting).	122
Figure 42: Cumulative costs of each cost category for scenario RO5 (all sectors, "Best" estimate scenario, without discounting).	125
Figure 43. Differences in PFCA and PFSA levels in the main German rivers and important tributaries (Danube, Elbe, Mulde, Rhine, Saale, Saar) in suspended particulate matter	

ANNEX XV RESTRICTION REPORT – PFAS IN FIREFIGHTING FOAMS

- (2005-2019) taken from Göckener et al. (2022)). Samples were analysed by classical target analysis (red) and direct Total Oxidizable Precursor (dTOP) Assay (blue). Spatial analysis took variations in sampling year (see Figure 51) and total organic carbon content into account. The red circle indicates an outlier..... 142
- Figure 44. Composition of PFAAs in livers of apex predators from Europe (2015-2018) taken from Androulakakis et al. (2022)) and Badry et al. (2022)). Terrestrial species: Common buzzard (*Buteo buteo*). Freshwater species: Eurasian Otter (*Lutra lutra*). Marine species: Grey seal (*Halichoerus grypus*), Harbour seal (*Phoca vitulina*), harbour porpoise (*Phocoena phocoena*). Mixed food web feeder: White-tailed eagle (*Haliaeetus albicilla*). All samples have been analysed by the same laboratory (University of Athens)..... 208
- Figure 45. Boxplot of PFOS concentrations in livers of apex predators from central Europe presented in Figure 44. Freshwater species: Eurasian otter (*Lutra lutra*). Marine species: Grey seal (*Halichoerus grypus*) from SE, Harbour seal (*Phoca vitulina*) from DE, NL, SE. Terrestrial species: Common buzzard (*Buteo buteo*) from DE, NL, UK. Mixed food web feeder: White-tailed eagle (*Haliaeetus albicilla*) from DE. All samples have been analysed by the same laboratory (University of Athens). The lower and upper hinges of the box correspond to the 25th and 75th percentile. The upper/lower whisker extends from the hinge to the largest/smallest value no further than 1.5* interquartile range from the hinge. Data points beyond are plotted individually by black dots. 209
- Figure 46. Boxplot of PFOS concentrations in pooled muscle samples of non-predatory fish species from Europe (Androulakakis et al., 2022). Freshwater species: Bream (*Abrahmis brama*) from DE NL, Roach (*Rutilus rutilus*). Marine species: Eelpout (*Zoarces viviparus*), Herring (*Clupea harengus*). All samples have been analysed in the same laboratory (University of Athens). The lower and upper hinges of the box correspond to the 25th and 75th percentile. The upper/lower whisker extends from the hinge to the largest/smallest value no further than 1.5*interquartile range from the hinge. Data points beyond are plotted individually by black dots. 210
- Figure 47. Box and whisker plots of PFAS concentrations for A) PFAS groups, Σ FTOHs, Σ FtAs, Σ FOSAs, Σ FOSEs, Σ PFCAs and Σ PFsAs and B) individual PFsAs and PFCAs in air (sum of particle and gas phases) measured in the Canadian Arctic from the Amundsen icebreaker (2010–11) reviewed by Muir et al. (2019). Boxes correspond to the interquartile range (25th and 75th percentiles), whiskers to the 5th and 95th percentiles. 2010 FOSAs and FOSEs are excluded owing to contamination in 2010 by MeFOSA and MeFOSEs. 223
- Figure 48. Average concentrations (pg/L) of C6–C10 PFCAs in Arctic seawater based on 9 in studies reviewed by Muir et al. 2019. 225
- Figure 49. Concentrations and patterns of a large suite of PFASs in ringed seal liver from northern Canada and east and west Greenland (na = not analyzed). Based on data from Muir et al. (2019, 2015) and Gebbink et al. (2012). 229
- Figure 50. Concentrations and patterns of C6–C16–PFCAs in liver of common eider (*Sklinna, Røst, Norway*), herring gull and shag (*Sklinna, Røst, Norway*), thick-billed murre and northern fulmar (Prince Leopold Island, Lancaster Sound, Nunavut) and in plasma of black-legged kittiwakes (*Kongsfjorden, Svalbard*). Results from Norway are from (Huber et al., 2015, Tartu et al., 2014) and for Nunavut from Braune et al. (Braune et al., 2014b) 231

ANNEX XV RESTRICTION REPORT – PFAS IN FIREFIGHTING FOAMS

- Figure 51. Time trends in percent per year in suspended particulate matter (2005-2019) sampled in the main German rivers and important tributaries (Danube, Elbe, Mulde, Rhine, Saale, Saar) taken from Gökener et al. (2022)). Samples were analysed by classical target analysis (red) and direct Total Oxidizable Precursor (dTOP) Assay (blue). Trend analysis took variations in river system and total organic carbon content into account. n.s = non-significant trend. The red circle indicates an outlier. 236
- Figure 52. Time trends of trifluoroacetic acid (TFA) in leaves [$\mu\text{g g}^{-1}$ dry weight] of the European beech (*Fagus sylvatica*) from four locations in Germany (taken from Freeling and Scheurer (2021))). 238
- Figure 53. Time trend of HFC-134a (+5.19 ppt per year) in air sampled at the Zeppelin station in Svalbard between 2001-2020 in ppt (taken from NILU (2021))). 239

EQUATIONS

Equation 1	70
Equation 2	70
Equation 3	70
Equation 4	70
Equation 5	71
Equation 6	71
Equation 7	71
Equation 8	71
Equation 9	72
Equation 10.....	73
Equation 11.....	73
Equation 12.....	73
Equation 13.....	74
Equation 14.....	74
Equation 15.....	74
Equation 16.....	75
Equation 17.....	75
Equation 18.....	75
Equation 19.....	76
Equation 20.....	76
Equation 21.....	76

ANNEX XV RESTRICTION REPORT – PFAS IN FIREFIGHTING FOAMS

Equation 22.....	76
Equation 23.....	77
Equation 24.....	77
Equation 25.....	77
Equation 26.....	77
Equation 27.....	77
Equation 28.....	77
Equation 29.....	78
Equation 30.....	78
Equation 31.....	78
Equation 32.....	78
Equation 33.....	78
Equation 34.....	78
Equation 35.....	78

Appendix 1. Stakeholders survey on techniques to clean equipment

1.1. “Non cleaning”

There seems to be no official guideline that lays out the practical details the transition from PFAS-based foam to fluorine free foam, describing for example cleaning procedures and accepted remaining levels. Thus, companies and fire brigades have been developed their own replacement strategy. Based on the input of stakeholder this included, in comparison to “cleaning techniques”, no washing steps with water.

1.1.1. Background

One stakeholder from Germany shared their experiences after transition from C8-based foam (3M Lightwater which is supposed to be based on PFOS) to C6-based foam without a cleaning procedure. After the replacement, the C6-based foam was tested for its PFAS content and high concentration of PFOS were found.

In the end this observation led to the development of a cleaning procedure specialized on foam concentrate tank located at industrial fire brigades. This procedure is explained in detail in section 1.9.

Also, another stakeholder from Norway stated that when a first round of replacement of PFASs to non-fluorine foam took place, no official cleaning protocol has been used. The PFAS-foam was simply drained and new foam (fluorine free) was filled in. However, follow-up measurements then showed that PFASs were still detectable.

1.1.2. Replacement Procedure

According to one stakeholder, the PFAS-foam was simply drained and new foam (fluorine free) was filled in. No more information available (Equinor-Ystanes-Interview, 2021).

1.1.3. Remaining PFAS concentrations

Legacy C8-contamination levels as measured by the PFOS-concentration are reported to be 28.000 µg/kg(which is higher than the threshold of 10 000 µg/kg according to the POP-regulation (10 ppm)). The stakeholder from Norway used a limit is 0,001 % (10 ppm) PFASs and had to refill tanks twice in a couple of cases to get below this limit.

1.1.4. Costs

No information on costs of the actual replacement strategy is available. Secondary costs are due to the incineration of the replaced foam.

As highlighted above, both stakeholders have been faced with contamination of the new foams with legacy PFAS-substances (like PFOS). Based on this contamination both stakeholders decided to develop cleaning strategies and had to start the process again.

1.1.5. Additional information and available case studies

See above.

1.2. Cleaning procedure by BIOEX

According to their homepage¹, BIOEX launched 2002 the first fluorine-free Foam on the market: ECOPOL. The BIOEX customer support services provide customer assistance in case of urgent need of foam concentrate, foam sample analysis and testing. BIOEX provides a foam calculation tool defining foam concentrate needs. BIOEX also supports companies in their transition to Fluorine-Free Foam (F3).

1.2.1. Background

According to the BIOEX homepage, BIOEX F3 foams are compatible with existing proportioning equipment. We must define appropriate foam application rate and discharge duration. It may induce minor system modifications.

1.2.2. Cleaning Procedure

PFAS cleanout with replacement costs and time. BIOEX recommends the following cleanout protocol, in case downstream users don't want to replace pump and storage tank:

1. Drain all foam from tank
2. Flush tank and pipes with hot water and scrub where possible
3. Rinse water analysis at lab to confirm PFAS cleanout
4. F3 Foam replacement: tank refilling with F3
5. Test/commissioning with the concentrate: the finished foam quality is highly dependent on the hardware (foam proportioning system, distribution system and discharge device)
6. Fluorinated foam disposal

Based on this protocol and the fact that the disposal of the cleaning water is not discussed, it can be assumed that water stemming from the cleaning itself are not disposed as hazardous waste.

1.2.3. Remaining PFAS concentrations

There is no information available on remaining PFAS concentrations.

1.2.4. Costs

There is no information available on costs for this technique.

1.2.5. Additional information and available case studies

There is no information available on available case studies.

¹ See <https://www.bio-ex.com/en/our-services/transition-to-fluorine-free-foam>, last accessed at 05th February 2021

1.3. V171 by Arcadis

1.3.1. Background

According to the JOIFF-article (authored by Ian Ross and Peter Storch from Arcadis), decontamination of firefighting and fire suppression equipment is essential to limit carryover of PFASs from old foam usage. Triple rinse with water is not sufficient and leads to a significant volume of decontamination water that requires treatment. Arcadis recommends using specialized biodegradable cleaning agents such as V171 to effectively remove PFAS residuals from fire suppression systems to limit future liabilities and cost associated with PFASs contaminating F3 foams as a result of inadequate decontamination (JOIFFF, 2020).

Arcadis has developed methods for PFAS decontamination of piping and tank systems including the use of a proprietary biodegradable cleaning agent, V171. These methods and the cleaning agent have been successfully applied in foam transition projects to remove PFASs from steel and PVC piping systems, stainless-steel concentrate tanks, and underground wastewater tanks (JOIFFF, 2020). Also application in foam suppression systems, emergency response vehicles, and concrete sewer distribution systems are described (Anderson, 2021).

In Appendix 3.5 the technical performance and other details of this technique is described. The following information concentrate on the actual cleaning procedure.

1.3.2. Cleaning Procedure

The initial PFAS cleanout project in 2017 used a sequential series of aqueous rinses, high pH flushes and application of the cleaning agent as shown in Figure 1 presenting the sum of PFASs (28) TOP Assay results. The results demonstrated that water and high pH are ineffective for removal of PFASs from surfaces, as demonstrated by the relatively low concentrations of PFASs measured in these flush solutions. The elevated concentration in the cleaning agent demonstrated significantly greater PFAS mass removal even after multiple flushes of water and caustic solution.

Further work to clean PFASs out of a 20 m³ foam concentrate tank was conducted, and results are presented in Figure 1. This application demonstrated that soaking with the cleaning agent, followed by high-pressure washing can be effective. The importance of using TOP assay for analysis of PFASs was revealed.

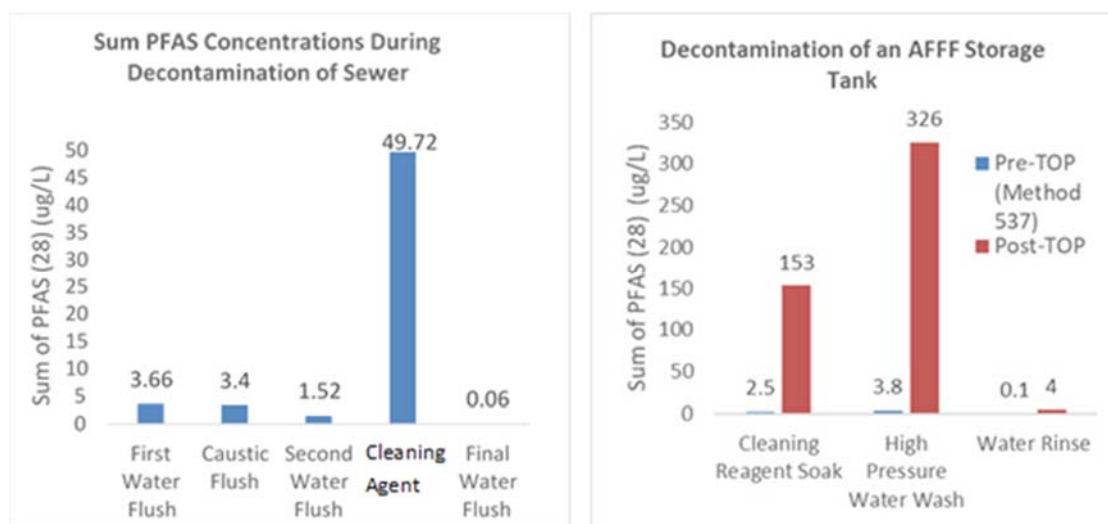

Figure 1. Sum of PFAS concentrations during decontamination of AFFF-Impacted sewer system and of a 20-m³ concentrate tank.

1.3.3. Remaining PFAS concentrations

As shown above in the diagrams of Figure 1, the final water flush/rinse contained around 0.1 µg/l PFASs as measured for the sum of 28 PFASs (according to TOP 4 µg/l).

1.3.4. Costs

There is no information available on costs for this technique.

1.3.5. Additional information and available case studies

Available case studies has been already discussed in Appendix 3.5 under “Additional information and available case studies”.

In addition, Arcadis claims that the technique has been successfully applied in foam transition projects to remove PFASs from steel and PVC piping systems, stainless-steel concentrate tanks, and underground wastewater tanks (JOIFFF, 2020). Also application in foam suppression systems, emergency response vehicles, and concrete sewer distribution systems are described (Anderson, 2021). For these projects, no documentation has been found via desktop search.

One ongoing study for the DoD focuses on Fire Suppression Systems:

- US-Department of Defense (DoD) concerning the “Demonstration and Validation of Environmentally Sustainable Methods to Effectively Remove PFASs from Fire Suppression Systems”².

² See: <https://www.serdp-estcp.org/Program-Areas/Environmental-Restoration/ER20-5364>

1.4. Cleaning procedure with PerfluorAd® by Cornelsen

1.4.1. Background

Detailed information on the background of this technique is provided in Appendix 3.4

1.4.2. Cleaning Procedure

Cleaning of PFAS Contaminated firefighting trucks and equipment as well as stationary fire extinguishing systems in the transition process from AFFF foams to fluorine-free foams with Cornelsen's PerfluorAd Technology is executed in 3 Steps (Cornelsen, 2021):

1. Complete and careful emptying of all system components (possibly even with partial replacement of components): pipes, hose lines, seals, valves, pumps, fittings, tanks including partitions and hidden areas, ...
2. Performing a flushing of all individual pipelines with a PerfluorAd dilution.
The last flushing is carried out with fresh Water. The visually recognizable foam formation serves as an indicator for the degree of cleaning.
3. Treatment of the collected rinse water directly on site with a further PerfluorAd application. Off-site disposal of rinse water does not take place. The PFAS content of the rinse water can already be significantly reduced when using the PerfluorAd technology exclusively.

The steps are identical for the cleaning of equipment of fire brigades and for stationary fire extinguishing systems. In Figure 2 the three individual steps of the cleaning procedure are shown schematically. The cleaning of stationary equipment is shown at the left and the cleaning of fire brigade machines is shown at the right (no illustration available for the first step).

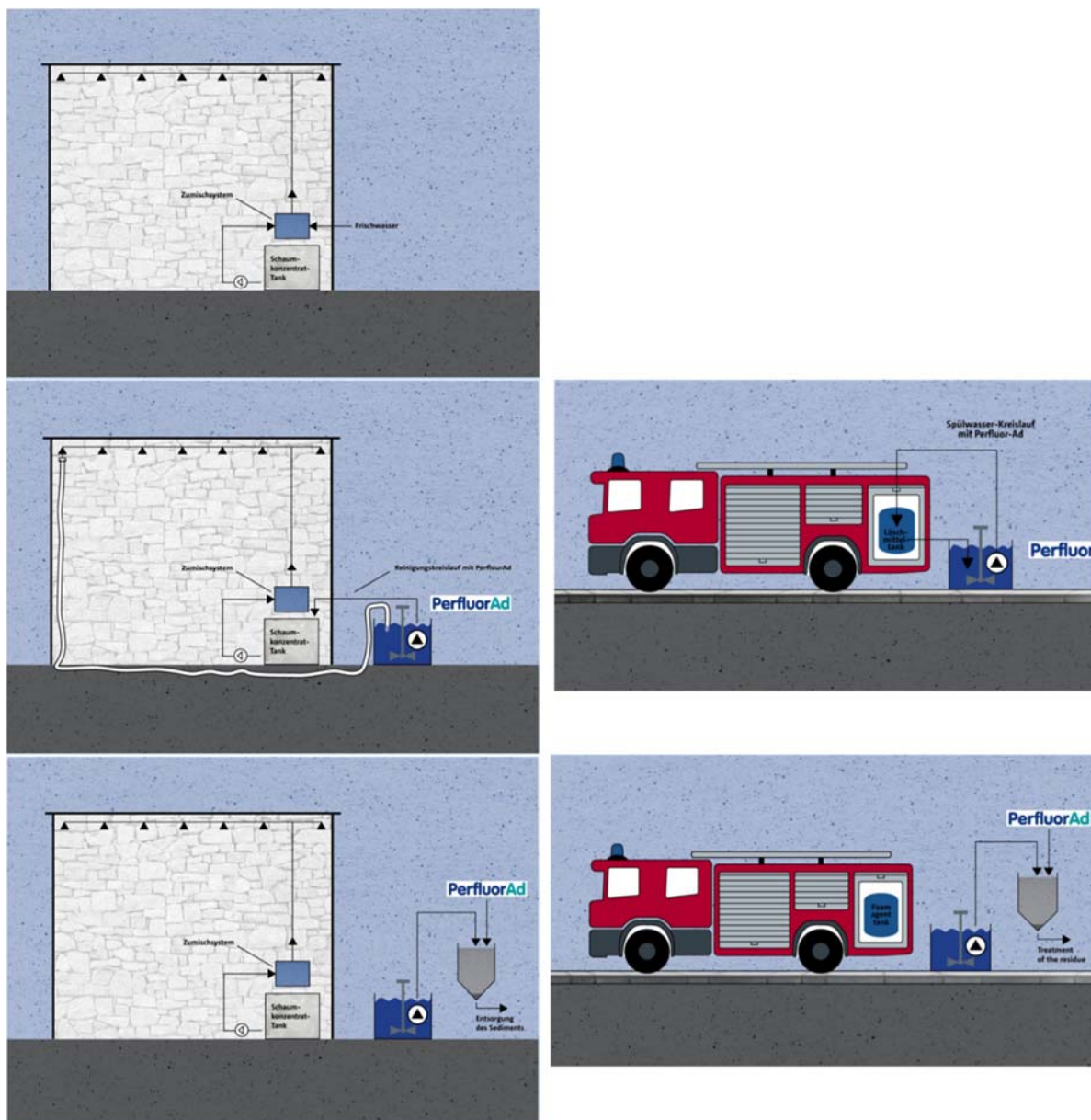

Figure 2. Schematic overview on the three individual steps of the cleaning procedure are shown schematically. The cleaning of stationary equipment is shown at the left and the cleaning of fire brigade machines is shown at the right (no illustration available for the first step).

1.4.3. Remaining PFAS concentrations

According to Cornelsen, the achievable PFAS residual concentrations in the system depend on several factors:

- Degree of emptying of the entire system (do PFASs deposits still remain in the system after emptying has been completed?)
- Materials present in the system (plastic, GFK, rubber, ...)
- Are all components accessible for mechanical cleaning (steam jet, brush, ...) or can adhesions remain in places that cannot be seen?
- What is the effort involved in replacing "critical components" (e.g. are all seals and plastic parts replaced before cleaning?)
- If complete emptying is possible and subsequent "bleeding" of PFASs from individual components is impossible, and at least 3 (better 5) rinses with a PerfluorAd dilution

ANNEX XV RESTRICTION REPORT – PFAS IN FIREFIGHTING FOAMS

and a final rinse with fresh water are performed (depending on the boundary conditions described before, flushing water volumes of >15 to <30 m³/vehicle are often required in practice),

Considering all of these factors, using the PerfluorAd technology final residual concentration (measured in the final rinse with fresh water) of less than 1.0 µg/l total PFASs, very often less than 0.3 µg/l to 0.0 µg/l can be achieved (see Figure 3).

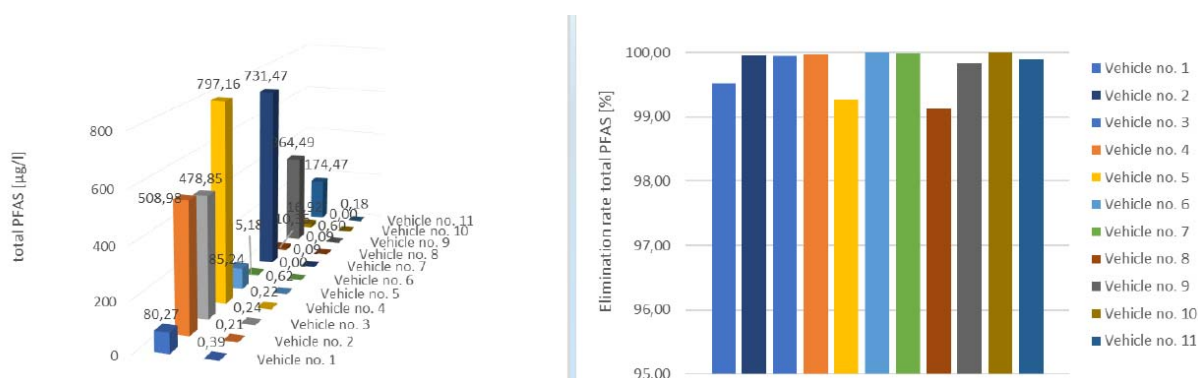

Figure 3. Results of the Cleaning of Fire Trucks using PerfluorAd.

1.4.4. Costs

According to Cornelsen, several parameters affect the price such as the size, type or age of the vehicle, if disposal of the AFFF concentrate needs to be performed, the place of cleaning (on-site or off-site). Depending on these boundary conditions, the costs are usually between 20 000-25 000 Euro/vehicle. These figures include the treatment of all rinsing water and all disposal costs (Cornelsen-Interview, 2021).

1.4.5. Additional information and available case studies

- A typical PerfluorAd application is the cleaning of fire brigade trucks. For this, Cornelsen GmbH is accredited by a German environmental authority. The process takes approx. one working week (Monday to Friday). However, a longer time is needed if components need to be replaced. Cornelsen GmbH provides the equipment and needed personnel.
- In large fire extinguishing systems, a replacement of critical components (plastics, etc.) is advisable to remove PFAS-substances and to prevent future “bleeding” of PFAS-substances.
- The state of North Rhine-Westphalia has funded the production of a mobile extinguishing water treatment plant (MLB) using the PerfluorAd process, mobilizable at short notice, i.e. transported to the site of the fire, so that the collected PFAS-contaminated firefighting water can be purified directly on site. With the approval of the responsible authority, the cleaned water is discharged into the sewer system. Alternatively, the MLB can also be used directly at sites with the consent of the responsible authority. The MLB can also be used directly at locations where collected extinguishing water is temporarily buffered, e.g. at waste disposal companies, sewage treatment plants, etc. The operation of the MLB and the cleaning process of the collected extinguishing waters are carried out by Cornelsen as services.

1.5. Cleaning protocol by the Bavarian State Ministry for the Environment and Consumer Protection (LfU)

1.5.1. Background

The Bavarian State Ministry of the Interior, Sports and Integration and the Bavarian State Ministry for the Environment and Consumer Protection in cooperation with state fire department schools, working group of professional fire departments, state fire department association, plant fire brigade association, Bavarian insurance chamber and VdS Loss Prevention GmbH published a document about the environmentally friendly use of firefighting foams in September 2019 (LFV-Bayern, 2019).

Topics are environmental relevance of foam extinguishing agents, distinguishing between fluorine-containing and fluorine-free foam extinguishing agents, the evaluation of the environmental compatibility of foam agents, as the basics of extinguishing foam, procurement, use and disposal.

Below, a summary of the cleaning instructions of equipment when replacing fluorine-containing with fluorine-free foam extinguishing agents from this guidance is provided. The main goal, as described in the guideline is to prevent contamination of fluorine-free foam concentrate with PFASs.

In general, the guideline recommends not to reuse used foam concentrate canisters and intermediate bulk containers (IBCs) that contained fluorosurfactant foam concentrate. Furthermore, in the case of smaller tanks and IBCs, the guideline states that disposal might be more efficient compared to a time-consuming cleaning procedure. Permanently-installed foam concentrate tanks in vehicles must be thoroughly cleaned before refilling with fluorosurfactant-free foam concentrate.

Ramboll interviewed Dr. Michael Gierig from LfU to collect further information.

1.5.2. Cleaning Procedure

Good cleaning results can be achieved with stainless steel tanks and tanks made of polyethylene or glass-fiber reinforced plastic (GRP), on condition that the tank cleaning is carried out very carefully.

In detail, the LfU-GL is recommending the following cleaning procedure for stainless steel tanks, GRP and polyethylene tanks:

1. Complete draining of the foam concentrate (dispose of foam concentrate)
2. Remove foam concentrate residues mechanically and by rinsing with hot (50-60 °C) water. All pipes and fittings carrying foam concentrate must also be rinsed during this process. The rinsing process is sufficient when the draining water no longer foams. The flushing water must be disposed of³.

³ Referring to the Lfu-guideline foaming agents containing fluorine surfactants must be disposed of by suitable disposal companies (German waste code number usually 16 10 01* = aqueous liquid waste containing hazardous substances). Certified disposal companies can be researched at www.lfu.bayern.de/abfall/entsorgerfachbetriebe/recherche/index.htm .

3. The tank, the lines and fittings carrying the foaming agent must be completely filled with water that is as hot as possible. The water must remain in the tank for at least 24 hours. After that, the water must be completely drained and disposed of.
4. The tank, the pipes carrying the foaming agent and the fittings must be completely filled with hot water three more times. The water must remain in the tank for at least 24 hours each time. The rinsing water from these rinsing processes can - if careful procedures are followed - be discharged via the sewage system into the sewage treatment plant.

1.5.3. Remaining PFAS concentrations

According to stakeholder knowledge, the effectiveness of the cleaning is monitored by measurements. A foam concentrate tank can then be released for further use if sufficient cleaning success is guaranteed. As a rule, concentrations below 10 ng/l of each of the 13 standard PFASs⁴ can be achieved with the cleaning procedure described in the guide and, if necessary, replacement of all accessible seals (LfU-Gierig-Interview, 2021).

The stakeholder reported, that usually < 10 ng/l, i.e. 10 ppt, related to foam concentrate tanks in fire engines are achievable. LfU does not have any figures for stationary extinguishing systems. LfU also sometimes accepts cleaning efficiencies the range of 100 ng, when special circumstances are to be considered (PFAS-emitting gaskets cannot be replaced).

1.5.4. Costs

Costs are available for tank fire engines. Costs are approx. 100 000 – 200 000 € per engine, when a permanently installed foam concentrate tank is cleaned before refilling with fluorosurfactant-free foam concentrate.

1.5.5. Additional information and available case studies

- According to stakeholder knowledge, the Munich Fire Department has cleaned its permanently installed foam concentrate tanks according to this guideline. Likewise, other fire departments in Bavaria are likely to have successfully cleaned their foam concentrate tanks according to this procedure (LfU-Gierig-Interview, 2021).

1.6. Cleaning protocol by Fire Rescue Victoria (FRV) - Appliance PFAS Decontamination Project

In Australia, Fire Rescue Victoria and the United Firefighters Union developed a decontamination procedure for appliances (fire trucks). FRV have assisted several other emergency service agencies, to either advise or provide similar decontamination processes for their respective firefighting appliances. FRV are considered national leaders in the successful implementation of measurable PFAS mitigation work.

⁴ Measurements based on DIN 38414-14 the German standard methods for the examination of water, waste water and sludge - Sludge and sediments (group S) - Part 14: Determination of selected polyfluorinated compounds (PFC) in sludge, compost and soil - Method using high performance liquid chromatography and mass spectrometric detection

1.6.1. Background

The Victorian Metropolitan Fire and Emergency Services Board (MFB) previously used PFAS-containing Aqueous film forming foams (AFFF) as firefighting foam. In 2007, MFB made a decision to replace existing firefighting foam with fluorine-free firefighting foam. This decision was due to concerns related to firefighters' health and environmental issues. MFB then phased out the use of persistent PFAS-containing firefighting foams across its operations.

MFB engaged expert independent environmental consultants to analyse PFAS exposure pathways for MFB firefighters on the job. This report was used to inform and develop MFB PFAS threshold limits and prioritise PFAS mitigation work.

The MFB (FRV) developed and formally endorsed an 'Operational Use of Firefighting Foam Policy' and the use of fluorine-free foam. Victorian Environmental Protection Authority (Vic EPA), and Victorian WorkSafe played a part to formalise this policy.

By 2014, all MFB firefighting appliances had been converted to only carry fluorine-free B Class foam in their foam tanks. Following the MFB establishment of the PFAS thresholds, in 2016, MFB initiated a process to test and decontaminate the MFB firefighting fleet. Further work is currently being done to decontaminate FRV appliances which have been more recently introduced and to monitor the previous PFAS decontamination work on the earlier MFB appliances.

1.6.2. Cleaning Procedure

FRV used environmental consultants and industrial cleaning partners to develop a 32-stage decontamination and verification process targeted at ensuring that the appliances, after decontamination, can be safely returned to service. The steps are summarized below (information taken from a presentation submitted by a stakeholder (Fire-Rescue-Victoria, 2021):

1. Suitable facility for the PFAS decontamination process: fire trucks are taken to a dedicated decontamination facility where the removable components (hoses, connectors, ladders, etc.) are stripped off for separate decontamination. The trucks are then put into a banded system, where the raw foam is carefully pumped out and the tanks prepared to be flushed and cleaned.
2. Flushing of the tanks: the tanks are carefully flushed with water which is slowly introduced at a controlled temperature to maximise raw product foam removal whilst minimising foam creation. Wastewater is collected for future processing and disposal. After removal of the majority of foam product, agitation is applied to break down and dissolve solidified foam products. Separate, colour-coded pumps and pipelines/lines are maintained to ensure that cross-contamination is avoided. Filters, strainers and breathers are carefully dismantled to allow removal of solidified foam product found to have built-up inside on-board components, wherever there are gaps, welds, connectors, or in joints and gaskets.
3. Cleaning of truck internals: the on-board water pumps are fed by, and feed, an intricate series of pipes, lines and injectors. Cross contamination has been found to be common, and the pumps and feed lines internal to the truck need to be cleaned.
4. Cleaning of delivery systems: delivery of foam/water mix can be through on-board hose reels, direct to hose systems from the main delivery panels on the side of the trucks, or from what is termed 'the monitor', a roof-mounted delivery system. Each of these has also to be decontaminated.
5. Purging of truck internal lines: a specially designed multi-part manifold is connected to the truck and the internal pump systems. Lines and foam injectors are purged.

ANNEX XV RESTRICTION REPORT – PFAS IN FIREFIGHTING FOAMS

6. Cleaning of onboard components: truck-mounted hose reels and monitor are decontaminated by flushing with clean water. Ground-spray systems are also flushed. Detachable components are decontaminated separately. Finally, the whole appliance is pressure washed. The interior voids on the truck, where the tanks and pumps sit, is also pressure washed. All washings are collected using a wet-vac system, for subsequent treatment.
7. Cleaning of removable components: each truck also has a series of removable components such as firefighting hoses, connectors, uptake and transfer hoses that need to be decontaminated.
8. Hose decontamination: firefighting hoses are decontaminated both externally and internally using a series of specially design hose-washing units. Several lengths of hose are connected to a high-pressure water recycling unit for internal decontamination. This device has a 5 000 litres water tank and a pump capable of high-pressure delivery

According to FRV, the key to successful decontamination is the correct sequencing of operations and detailed recording of each stage of operations. Each truck decontamination can create between 6 000 to 8 000 liters of wastewater. Wastewater is re-concentrated by passing through a series of activated carbon filters (GAC). It has been possible to strip out the PFAS foam from the waste and achieve sub part-per billion results in the treated wastewater, enabling this to be disposed to trade waste, with the carbon sent for high temperature destruction. Figure 4 illustrates with pictures the decontamination process and Figure 5 the achieved PFAS residual concentrations.

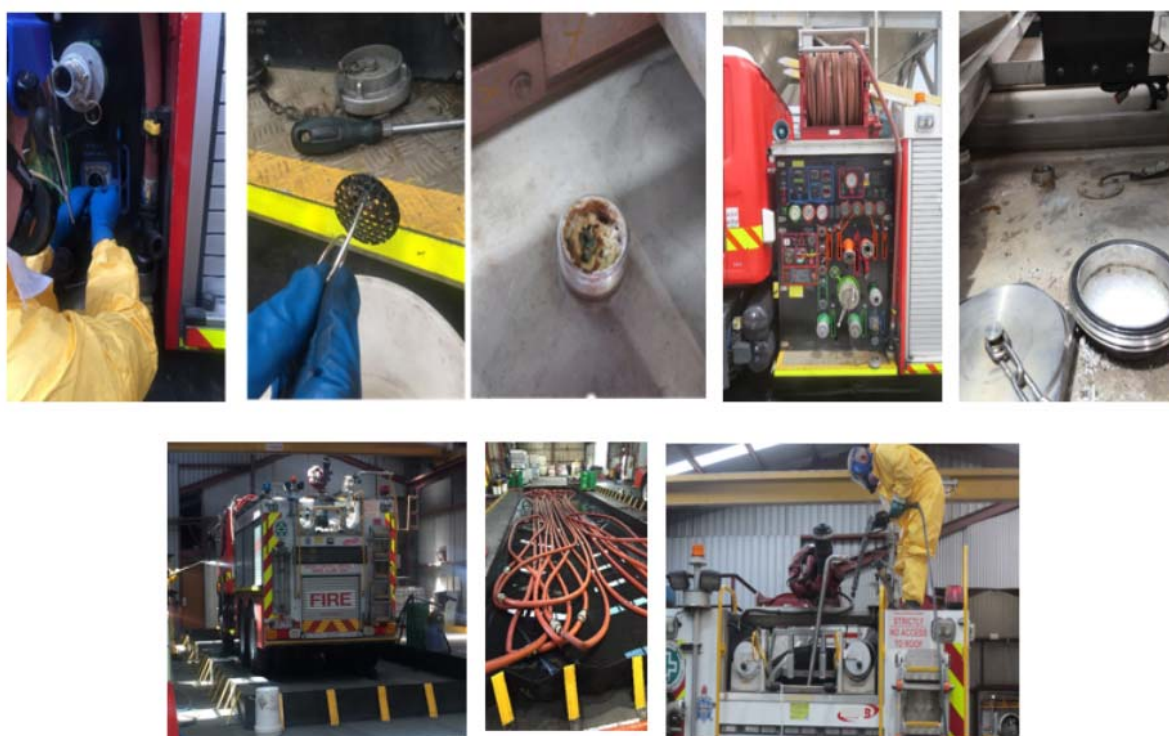

Figure 4. The Decontamination Process – in pictures (taken from ((Fire-Rescue-Victoria, 2021))).

1.6.3. Remaining PFAS concentrations

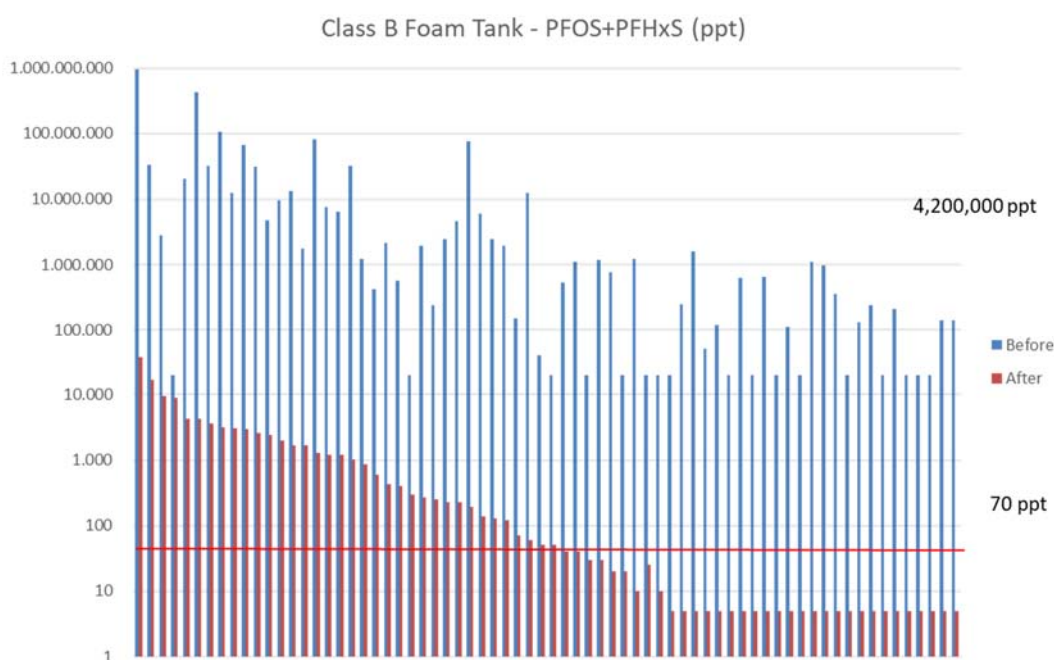

Figure 5. Achieved PFAS levels after decontamination according to the protocol by FVR, before (blue) and after (red) (taken from (Fire-Rescue-Victoria, 2021)).

For the remaining PFAS levels, a two-tier decontamination has been chosen. FRV firefighting urban operations and routine training are two very different scenarios. In urban operations, a firefighter might deploy foam in one fire in every 20–50. Water is deployed into a highly modified urban environment. In routine training the same location (a fire training facility) is repeatedly exposed, on a daily basis, to water deposition from fire appliances. If that water was even slightly contaminated, there was a risk of progressive build-up of PFASs in the soil and run-off. For that reason, the target for fire trucks for training purposes became “drinking water standard”.

For a decontaminated fire appliance, that was translated as meaning no sample exceeded 70 parts per trillion for PFASs.

The MFB commissioned a risk exposure pathway analysis that determined PFAS thresholds levels for both training and operations. Based on this, the remaining PFAS concentrations have been set and can also be reached using the described protocol, see below Table 1.

Table 1. PFAS residual thresholds (taken from (Fire-Rescue-Victoria, 2021))

Endorsed Residual Threshold Limits	FRV Appliance PFAS	Sum of PFOA	Sum of PFHxS and PFOS
Derived Human Health Levels	Threshold	21,800 ppt	413,000 ppt
FIRE FIGHTING OPERATIONS LEVEL (Green Sticker)		(Parts Per Trillion) 21 ug/l	(Parts Per Trillion) 413 ug/l
DEMTC (Victorian Emergency Management Training Complex) Craigieburn Levels		70 ppt	70 ppt
FIRE FIGHTING TRAINING LEVEL (Blue Sticker)		(Parts Per Trillion) 0.07 ug/l	(Parts Per Trillion) 0.07 ug/l

1.6.4. Costs

There is no information available on costs for this technique.

1.6.5. Additional information and available case studies

Since 2016, over 145 fire rescue vehicles and CFA firefighting appliances and over 150 km of firefighting hoses have gone through this PFAS decontamination process to below the established thresholds and have been successfully cleaned and returned back into commission for operational use. This work has been conducted in a quantitatively measurable manner by independent third parties.

1.7. Cleaning protocol by FPA Australia

1.7.1. Background

Fire Protection Association Australia (FPA Australia) is the national peak body for fire safety, providing information, services and education to the fire protection industry and the community. According to an information bulletin provided by FPA Australia, changing from a foam containing PFOS or PFOA to a US EPA PFOA Stewardship compliant C6 foam, a REACH Regulation (EU) 2017/1000 compliant C6 foam or an F3 foam will require thorough washing of the tank and concentrate sections of pipework (including proportioners) until no frothing is visible (FPA-AUS, 2020). It also requires collection, remediation and safe disposal of all effluent from this washing process.

1.7.2. Cleaning Procedure

FPA Australia recommends the following process when cleaning foam tanks or changing out existing C8 foams:

1. Decant existing C8 foam into suitable storage containers, which are also banded and clearly marked for incineration/destruction.
2. Thoroughly flush system with water and collect effluent in suitable storage containers/tankers, identifying contents. The use of hot water may facilitate cleaning.

3. Using suitable remediation technologies, flushed foam solution and effluent should be treated to concentrate the PFASs into as small a volume as practical and should be held separately and labelled prior to disposal/destruction.
4. Analyse clean water for residual PFAS levels, before any release for re-use to the sewer/environment to ensure local regulatory requirements are met.

This is likely to require temporary storage in large clean tanks without any previous PFAS usage or potential pre-existing PFAS contamination.

5. Send concentrated PFAS containing materials for disposal/destruction in accordance with local regulatory requirements.

1.7.3. Remaining PFAS concentrations

To avoid the possibility of contamination, the tank should not be filled with the replacement foam until the results of this testing are available and confirm sufficiently low levels acceptable to the local environmental regulator.

1.7.4. Costs

There is no information available on costs for this procedure.

1.7.5. Additional information and available case studies

There is no information available on case studies.

1.8. Cleaning protocol by the Australian DoD

1.8.1. Background

The Australian Aircraft Rescue & Firefighting (ARFF) foam transition project will transition all Army, Air Force and Broad spectrum firefighting vehicles to a suitable Fluorine Free Foam (F3) product (DoD-AUS, 2020b). As described in the figure below (Figure 6) the cleaning procedure relies on the set up of 10 cleaning hubs, where over 100 vehicles will be cleaned. In the following only a brief overview of the procedure is given.

ANNEX XV RESTRICTION REPORT – PFAS IN FIREFIGHTING FOAMS

AIRCRAFT RESCUE FIREFIGHTING FOAM TRANSITION PROJECT

Version 8
Live Document: current as at 10 September 2020

About the project

The Aircraft Rescue & Firefighting (ARFF) foam transition project will transition of all Army, Air Force and Broadspectrum firefighting vehicles to a suitable Fluorine Free Foam (F3) product. The ARFF Vehicle Foam Transition Sub Working Group will manage this project under delegation from the One Defence Firefighting Foam Management Working Group.

Defence is required to maintain firefighting capability to support the Australian Defence Force (ADF) in its mission to defend Australia and its national interests.

Effective firefighting capability is essential to protect life and assets.

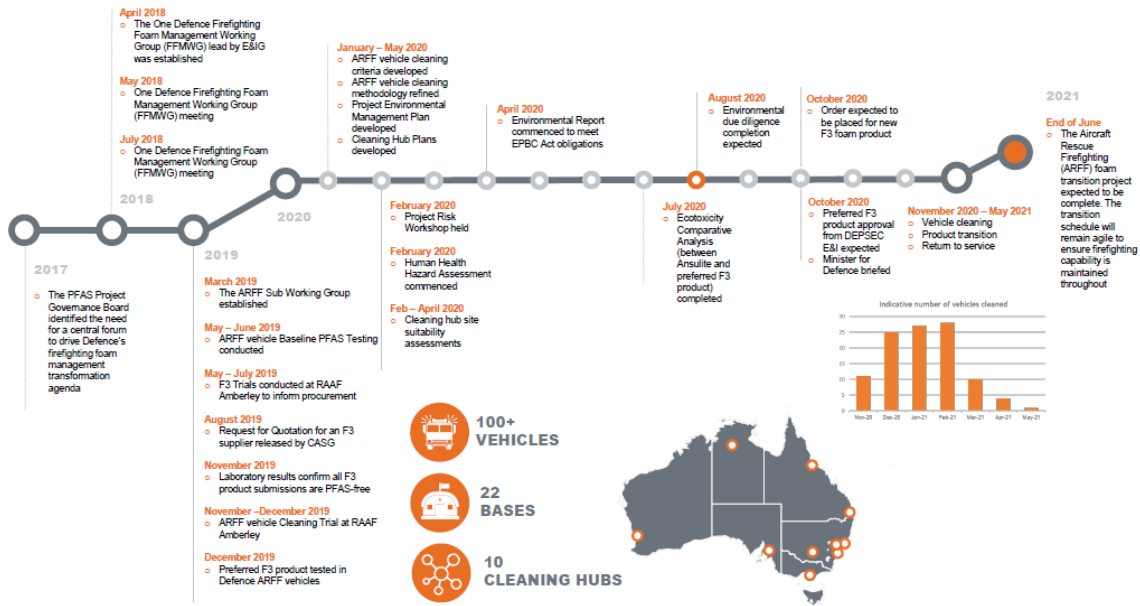

Figure 6. Overview on the Aircraft Rescue & Firefighting (ARFF) foam transition project (DoD-AUS, 2020a)

1.8.2. Cleaning Procedure

FPA Australia recommends the following process when cleaning foam tanks or changing out existing C8 foams (see also illustration in figure 23):

1. Decanting Aqueous Film Forming Foam (AFFF). ARFF vehicles will be decanted of AFFF
2. A continuous flush is applied
3. Sample baseline
4. Vehicle CES soaking
5. Outlet and hose flushing
6. Sample for validation
7. Re-fill with F3. ARFF vehicles will be re-filled with F3 upon completion of the required cleaning activities set out in step 4. The Hub Supervisor will apply a colour coded zip tie to cleaned CES items associated with the vehicle to identify them as F3 only.
8. Proportioner Calibration and Return to Service Testing (RTS): The User Units will conduct vehicle foam performance tests (including proportioner calibration) inside, or at, the designated foam test facility or area as per existing testing arrangements.
9. Restart next vehicle
10. Vehicle validation against cleaning criteria



Figure 7. Cleaning procedure phases in accordance to the Queensland DoD (DoD-AUS, 2020c)

1.8.3. Remaining PFAS concentrations

There is no information available for the remaining PFAS concentration.

1.8.4. Costs

There is no information available on costs for this procedure.

1.8.5. Additional information and available case studies

There is no information available on case studies.

1.9. Cleaning protocol by the German industrial plants fire brigades association (Werkfeuerwehrverband Deutschland - WFVD)

According to WFVD's homepage⁵, the company fire protection organisation must take into account the specificities of companies' risks. As a result of the need to adapt to company-specific conditions, the principles and guidelines established for public fire departments cannot be directly transferred to plant and company fire departments.

1.9.1. Background

In 2014 it was noticed that during the transition from C8 (PFOS-based) foam to C6 (PFHxA precursor based) foam, the tanks were not cleaned sufficiently. Residues of the C8-based foam contained high amounts of PFOS and contaminated the new PFOS-free AFFF.

On this basis was developed a foam concentrate tank cleaning procedure. According to WFVD, from these cases it can be concluded that the cleaning procedure is an effective method to apply when transitioning from PFAS-based to fluorine-free foam. It is simple enough to be carried out by fire brigades themselves or for example by companies that specialise in industrial cleaning. It sufficiently reduces PFAS levels below applicable standards and is adjustable in case the results do not meet expectations.

⁵ See <https://www.wfvd.de>, last accessed 24.03.2021

1.9.2. Cleaning Procedure

The foam concentrate tank cleaning procedure is a relatively simple process that in many cases can be carried out by fire services themselves. Basically, it comprises a series of flushing with water, after the tank is emptied. The main challenge in this process is to avoid spills and contamination of equipment outside the foam concentrate tank. During step 2 and 3 the residues of the foam concentrate will cause foaming inside the tank. The overflow of that foam should be avoided to not cause any contamination outside of the tank.

Further attention should be paid to a proper disposal of the old foam concentrate and any rinsing water. The standard disposal method would be high temperature incineration in a facility that is able to handle PFAS waste.

WFVD recommends the following foam concentrate tank cleaning procedure:

1. Step 1:
 - a. Empty foam concentrate tank, pump and piping
 - b. Dispose foam agent through high temperature incineration
2. Step 2:
 - a. Fill tank with warm water (60-70°C) (half full to avoid overflow of foam)
 - b. Drive with apparatus for 30 minutes to allow contact of water with the whole inner tank surface
 - c. Pump water with foam pump in a loop for about 30 minutes
 - d. Empty tank, pump and piping
 - e. Destroy the foam inside the tank with water and a very fine nozzle and empty tank again
 - f. Dispose water through high temperature incineration
3. Step 3:
 - a. Repeat step 2 one time
4. Step 4:
 - a. Fill tank with water
 - b. Pump water with foam pump in a loop for about 30 minutes
 - c. Take a water sample
 - d. Analyse water sample for PFASs
 - e. Repeat Step 3 if results of PFAS analysis are not sufficient
 - f. Dispose water through high temperature incineration
5. Step 5
 - a. Drain any rinsing water from tank, pump and any pipes
 - b. Dry tank as much as practically possible
 - c. Fill tank with new foam concentrate

1.9.3. Remaining PFAS concentrations

According to WFVD, the efficacy of the foam concentrate tank cleaning procedure can be assessed when looking at Figure 8 and Figure 9.

The highest remaining PFAS-substances reported in Figure 8 are 6:2 FTS with 0.98 µg/L (0.00098 ppm) and PFOS with 0.81 µg/L (0.00081 ppm). The highest remaining PFAS-substances reported in Figure 9 are PFOS with 42 µg/L (0.042 ppm) and PFOA with 1.2 µg/L (0.0012 ppm). If all reported PFAS-substances are added a remaining concentration of 57.5 µg/L (0.057 ppm) is measured.

ANNEX XV RESTRICTION REPORT – PFAS IN FIREFIGHTING FOAMS

These are PFAS analyses of the rinsing water from step 4 of the procedure. As these are analyses for PFASs in water the detection limit for PFASs is lower than in the analyses for PFASs in foam concentrate. The analyses show that cleaning is effective with dilution factors varying between 100 and 100 000. While PFASs can still be detected in the rinsing water in all cases they are lower than current applicable thresholds for PFOS (not further commented by the stakeholder but most likely 10 ppm according to POP-regulation) and PFOA (not further commented by the stakeholder). If the results do not meet expectations, steps 2 and 3 can be repeated until levels are sufficiently low. It has to be noted that the water analysed in step 4 will also be disposed and that PFAS levels can be assumed to be even lower when the new foam concentrate is filled in.

Beschreibung	Messwert	Einheit	Verfahren
4H-Perfluordecansulfonat (8:2 FTS)	0,045	µg/L	
4H-Perfluorhexansulfonat (4:2 FTS)	< 0,01	µg/L	
4H-Perfluoroctansulfonat (6:2 FTS)	0,98	µg/L	
Perfluorbutansäure	0,012	µg/L	
Perfluorbutansulfonsäure	0,039	µg/L	
Perfluordecansäure	< 0,01	µg/L	
Perfluorheptansäure	0,014	µg/L	
Perfluorhexansäure	0,097	µg/L	
Perfluorhexansulfonsäure	0,19	µg/L	
Perfluornonansäure	< 0,01	µg/L	
Perfluoroctansäure (PFOA)	0,037	µg/L	
Perfluoroctansulfonsäure (PFOS)	0,81	µg/L	
Perfluorpentansäure	0,011	µg/L	

Figure 8. PFAS Analysis of rinsing water from apparatus "TMB" from step 4 of tank cleaning procedure (note, that the detection limit is lower as this is an analysis for PFASs in water as opposed to PFASs in foam concentrate in other figures)

4H-Perfluordecansulfonat (8:2 FTS)	0,19	µg/L	
4H-Perfluorhexansulfonat (4:2 FTS)	< 0,01	µg/L	
4H-Perfluoroctansulfonat (6:2 FTS)	1,7	µg/L	
Perfluorbutansäure	0,31	µg/L	
Perfluorbutansulfonsäure	0,96	µg/L	
Perfluordecansäure	< 0,01	µg/L	
Perfluorheptansäure	0,39	µg/L	
Perfluorhexansäure	1,5	µg/L	
Perfluorhexansulfonsäure	11	µg/L	
Perfluornonansäure	< 0,01	µg/L	
Perfluoroctansäure (PFOA)	1,2	µg/L	
Perfluoroctansulfonsäure (PFOS)	42	µg/L	
Perfluorpentansäure	0,45	µg/L	

Figure 9. PFAS Analysis of rinsing water from apparatus "PTLF II" from step 4 of tank cleaning procedure (Note 1: The detection limit is lower as this is an analysis for PFASs in water as opposed to PFASs in foam concentrate in other figures. Note 2: This apparatus is also referred to as "TroTSLF 2" or "PTLF 2")

1.9.4. Costs

Costs for the cleaning of a foam concentrate tank of a fire apparatus highly depend on disposal costs for the foam concentrate and flush water, summing up to 50% of the total costs in this example (4 000 €). It is estimated that the volume of the flush water is three times that of the tank volume. Other costs, like work hours are likely to be independent from tank size (unless deviating to a greater extent from this example). In this case study the work was done by the industrial fire brigade itself, so that no external costs arose for work hours. See figure 26 for the estimated costs of the cleaning procedure.

ANNEX XV RESTRICTION REPORT – PFAS IN FIREFIGHTING FOAMS

Disposal of foam concentrate for 1 m ³	500€/m ³	500€
Disposal of flush water (3m ³)	500€/m ³	1500€
Work hours (2 people, 10h each)	50€/h	1000€
IBC totes for foam concentrate and flush water	150€/piece	600€
Small equipment estimate (PPE, contaminated hoses, etc.)	400€	400€
Total		4000€

Figure 10. Estimated costs for the cleaning of a 1 m³ foam concentrate tank with the described cleaning procedure

1.9.5. Additional information and available case studies

- Three years after the cleaning of the tanks, the foam concentrate was analysed for PFASs again. Except for one PFASs in the apparatus all PFASs are below the detection limit and below the applicable threshold for PFOS and PFOA. The reason for the measured concentration of 56 µg/kg of 6:2 FTS in apparatus "TMB" are not known. Possible explanations are the cross contamination from residues of old foam concentrate, contamination of the sample or a measuring error.
- The procedure is also explained in a video available at Youtube⁶. The stakeholder reported there are some mistakes concerning the values in the English version.

⁶ English : <https://www.youtube.com/watch?app=desktop&v=jNoDFsd4RnY&feature=youtu.be> ;
 German: <https://www.youtube.com/watch?app=desktop&v=29OxwWv1FiI&feature=youtu.be>

Appendix 2. Techniques for disposal of firefighting foam concentrates

This section describes the two industrial-scale level incineration techniques that could be used for the disposal of PFAS firefighting foam concentrates and possibly other PFAS waste originating from the use of PFAS firefighting foam and identifies at a high level the potential emissions associated with these disposal options. Emissions considered relate to both the potential for remaining PFAS compounds as well as the by-products created from disposal.

(Wood et al., 2020) concluded the following on incineration practices applicable to PFAS firefighting foam concentrates:

- **High-temperature incineration** would appear the most likely disposal option for PFAS-containing legacy foams⁷;
- **Existing incineration disposal methods used apply a range of temperatures from around 400-6 000°C⁸.** The literature also indicates that CF₄ requires temperatures above 1 400°C to decompose and that CF₄ is the most difficult fluorinated organic compound to decompose (US-EPA, 2020b);
- The effectiveness of PFAS compounds to be destroyed by incineration and “the tendency for formation of fluorinated or mixed halogenated organic by-products is not well understood” (US-EPA, 2020b);
- **The incomplete destruction of PFAS compounds may result in smaller PFASs or products of incomplete combustion being formed.** These products may not yet have been researched and therefore have the potential to be chemicals of concern (US-EPA, 2020b);
- The **complete combustion of PFOS/PFASs will result in CO₂, H₂O and HF** (Lundin and Jansson, 2017) and the incineration of PFASs at temperatures of at least 1 100°C, usually degrade PFASs to carbon dioxide and hydrogen fluoride (UNEP, 2012) in (KEMI, 2016). It has not yet been determined what is produced when PFASs is incinerated at temperatures lower than 1 100°C (KEMI, 2016);
- **Emissions (greenhouse gases and air pollutants) from creating high temperatures for incineration:** There are emissions associated with the procurement and delivery of fuel and with incinerator operation (e.g. greenhouse gases and air pollutants such as particulate matter from the combustion of fuels). Associated emissions have not been analysed and it is assumed that the incinerators would continue to operate at the same temperatures regardless of the type of waste they process. Such emissions were not highlighted by stakeholders in the consultation;
- **Leakage during storage and transportation:** Incineration processes are typically provided off-site and foams will need to be stored and transported to incineration facilities for disposal or waste equipment to be installed on-site. During the storage and transportation of PFAS-containing foam it may be possible for spillages or leakages to occur, resulting in environmental emissions. There has not been enough information identified during desktop-based research or provided from stakeholder consultation to accurately quantify these emissions;

⁷ Derived from stakeholder consultation responses concerning PFAS disposal methods. Note that WWT was also reported as a disposal method, but a judgement was made that these disposal techniques relate to used PFAS-containing firefighting foam rather than unused foam.

⁸ Obtained from stakeholder consultation.

- **Direct emissions (greenhouse gases and air pollutants) from transportation:** Where foams are stored and transported to incineration facilities, direct emissions of carbon and other pollutants (e.g. particulate matter and nitrogen oxides) from vehicles will also occur. Desktop-based research revealed a lack of available data regarding the geographical position of PFAS-containing firefighting foam manufacturers and users in relation to incineration facilities and little to no information was obtained from stakeholder consultation. It is therefore unsuitable to accurately quantify emissions associated with foam transportation.

Overall, PFAS emissions from incineration are not well studied (NordicCouncil, 2019); (Stoiber et al., 2020) and therefore, there is the potential for incineration to be hazardous. Further research is needed to identify and quantify the emissions produced from the incineration of PFASs, as well as greater research undertaken to understand the thermal properties of PFASs.

An additional stakeholder's consultation and literature search was conducted in 2021 by Ramboll for the Dossier Submitter (Ramboll, 2021) to collect further information on available disposal methods for PFAS foams concentrates and other PFAS waste such as the PFAS contaminated firewater run offs and waste from foam equipment cleaning. These findings are summarised below as regard to the incineration techniques. Appendix 3 describes other techniques available for the PFAS contaminated firewater run-offs and waste from foam equipment cleaning.

Only methods with a complete or maximised defluorination or mineralisation were considered. This excludes the treatment of PFAS foam concentrates and PFAS run-off water in typical municipal and industrial wastewater treatment plants and the disposal on landfills as these methods do not effectively destroy the containing PFASs (Houtz et al., 2018).

Furthermore, only large scale established, and financially feasible methods were looked at.

The incineration of PFASs is according to recent literature and stakeholder input the most reliable method for their destruction. Several authorities and associations also recommend the incineration of PFAS foam concentrate and run-off water as the most efficient method for destruction (AU-EPA, 2021, CA-EPA, 2021, FFFC, 2016).

Also, the collected input from stakeholders shows that the only available adequate disposal option for PFAS-containing foams is incineration at high temperatures. Based on available literature, the incineration is performed either in hazardous waste incinerators or cement kilns.

According to literature, some manufacturers and downstream companies offer to take PFAS-based foams back (sometimes only if new fluorine-free foams are purchased). For example, Bio-Ex offered in the past (year 2018-2019) to take back PFAS based firefighting foam when the same amount of fluorine-free foam was purchased⁹.

2.1. Physical destruction – Incineration in Hazardous Waste Incineration plants

a) Background

The strongest bond in a PFAS-molecule is the carbon-fluorine bond with a bond strength of 485 kJ/mol (Roesch et al., 2020). This bond needs to be broken in order to completely destroy a PFAS molecule. The breaking of only the carbon-carbon bonds may lead to the formation of shorter fluorinated molecules, such as ultra-short chain PFASs like trifluoroacetic acid and fluorinated gases like hexafluoro ethane (C₂F₆) and tetrafluoro methane (CF₄). The complete

⁹ For more information see <https://www.carl-henkel.de/assets/Uploads/PDF/170060AK-FLYER-BIOSCHAUM.PDF> accessed at 01.04.2021

ANNEX XV RESTRICTION REPORT – PFAS IN FIREFIGHTING FOAMS

thermal destruction, meaning mineralisation, of a PFAS molecule leads to hydrogen fluoride, water, and CO₂.

b) Technical performance

The main principle of waste incineration lies in the thermal breaking of the chemical bonds in a molecule. For this the Industrial Emission Directive (2010/75/EU, 2010) requires European waste incinerators to operate at a minimum temperature of 850°C with a residence time of at least two seconds.

In Europe, for hazardous waste with more than 1 % of halogenated organic substances (what would also apply to PFAS-based firefighting foam run-off and cleaning water) the incinerator needs to reach temperatures of at least 1 100°C (2010/75/EU, 2010). The respective incinerators are commonly called hazardous waste incinerators (HWI). To current knowledge, the conditions can break the chemical bonds of a molecule and transform the waste into CO₂, water, salt, and ash.

Hazardous waste incinerators are designed to handle and destroy the most difficult hazardous (explosive and/or toxic) substances. Hazardous waste incinerators have specialized systems for the input of waste material, depending on the type of waste being handled. This is particularly important for some of the most hazardous and toxic wastes. Options include a solid waste bunker, a tank farm for liquid and pasty wastes, drum storage and transportation facilities. For certain (highly reactive) wastes, a dedicated direct injection system is necessary.

The decomposition temperatures for PFASs vary depending on chain length and functional group. PFOA decomposes already at around 100 °C, FOSA at 150 °C, PFHxS and PFOS around 350 °C and PTFE at around 500 °C. At these temperatures the bonds inside the compounds are broken and gaseous fragments are formed. During the decomposition of PTFE, fragments such as •CF, •CF₃, •C₂F₄ and •C₃F₅ can be found which indicates that not all carbon-fluorine bonds were broken (Wang et al., 2015).

To completely mineralise PFASs to hydrogen fluoride, water and CO₂, higher temperatures are needed. According to current literature the temperatures should reach at least 1 100 °C to degrade PFASs to carbon dioxide and hydrogen fluoride (KEMI, 2016). The Danish Ministry of Environment published a report on the incineration of persistent organic pollutants (POPs) including PFOS. It is stated, that PFOS will be destroyed to more than 99 % by co-incineration and that other studies have shown a destruction efficiency of more than 99.97 % for fluorotelomers, chlorofluorocarbons and PTFE in conventional waste incineration. It is however also stated, that during the decomposition of PFOS at 900 °C simple fluorocarbons such as CF₄, C₂F₆, CHF₃ and C₂H₂F₂ will be formed (Lundin and Jansson, 2017). Among the fluorinated gases tetrafluoro methane (CF₄) is the hardest to destroy, as it only contains carbon-fluorine bonds.

The figure below describes the general process of a hazardous waste incinerator.

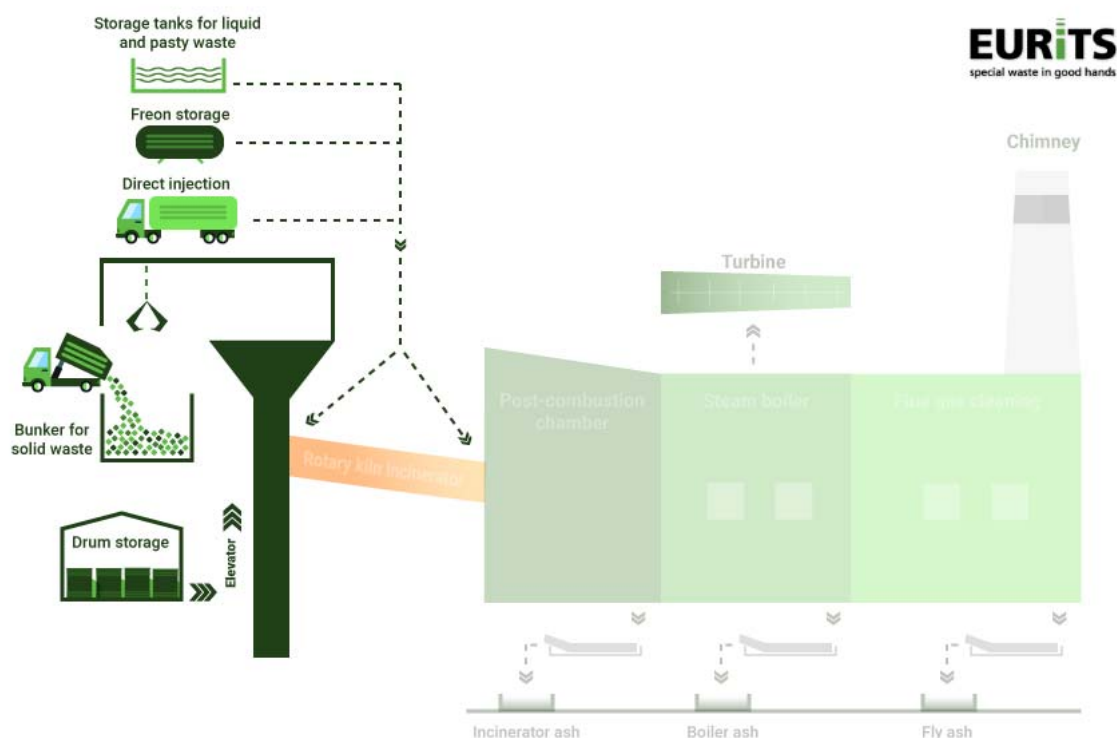

Figure 11. The hazardous waste incinerator process taken from Eurits [homepage](#)

c) Side products and emissions

A study performed in 2014 analysed the ash and waters arising from multiple waste incinerators in Sweden. The incinerators generally operated at temperatures above 850 °C and employed a flue gas cleaning process where the flue gas is first pumped through an acidic solution and then through a neutral step where sulphur dioxides are separated through the addition of lye. While multiple PFASs could be found in all sampled media the authors conclude that as the amounts were so low that waste incineration plants in Sweden are unlikely to contribute significantly to environmental emissions of PFAA (Sandblom, 2014).

According to data from the US, the end-product of the complete combustion of any organic compound will lead to carbon dioxide and water which will be emitted to the air. In the case of PFASs, hydrogen fluoride will also be formed if the compound is completely destroyed. It can be found in the bottom ash as well as the flue gas. In order to remove the HF from the gas, a gas scrubber is applied. For this, the hot flue gas is cooled in a quenching unit filled with water whereby the HF dissolves in the water. This step is then repeated with a multistep scrubbing tower where the flue gas is scrubbed with a sodium hydroxide solution to remove all remaining HF. The resulting effluent is then quenched in a calcium hydroxide solution where the dissolved fluorine precipitates as calcium fluoride. As this method employs an alkaline solution it may also remove any airborne charged PFASs such as PFCA and PFSA but can however not remove fluorinated gases(US-EPA, 2020a).

If the temperature is too low, products of incomplete destruction will be formed. These include for example CF_4 , C_2F_6 , CHF_3 , $C_2H_2F_2$ and C_3F_8 (US-EPA, 2020a, DK-EPA, 2019).

A quantitative analysis of the formation of these fluorinated gases during the combustion of PFASs has not yet been performed. In general, these gases have a high greenhouse gas potential and should be avoided. As the PFASs destruction efficiency of the thermal treatment is not 100 %, small amounts of PFASs will not be destroyed and as such can be emitted to air or be found in the fly and bottom ash. The ashes are often landfilled and the contained PFASs can thus be washed out and emitted into the water and ground. However, based on

data from Sweden, PFAS concentrations in fly and bottom ash are very low (26 – 748.3 pg/g) (Wohlin, 2020).

Another study concluded that in total less than 10 kg of PFAA are deposited on Swedish landfills per year from ash from waste incinerators (Sandblom, 2014).

Data from stakeholder interviews indicate that there is a need for standardisation and future scientific investigations:

- One stakeholder from Germany made it clear that there is still a need for research with regard to the incineration of PFAS-containing wastes and the associated issues, particularly with regard to the required minimum temperatures and possible products of incomplete incineration. In the past, investigations have already been carried out, for example at household waste incineration plants, but these often focused on individual substances such as PFOA and PFOS or long-chain compounds. Although it can be assumed that these compounds break down at sufficiently high temperatures and long residence times, the extent to which short-chain compounds or products of incomplete combustion (PICs) are formed or emitted and how these are to be evaluated has not yet been sufficiently researched according to current knowledge (LASTFIRE-Interview, 2021).
- Another stakeholder from Germany stated that currently measured background levels of PFAS substances must come via incineration. According to measurements in Bavaria, when PFASs is measured in soil, 50% of taken samples would be over current threshold levels as defined by the Bavarian PFC assessment guidelines (measurements based on DIN 38414-14) (LfU-Gierig-Interview, 2021).
- The same stakeholder also indicated that so far, there are no validated measurement methods for the determination of PFASs in exhaust air. However, a DIN-standard for the determination of PFASs in exhaust air is drafted right now. The stakeholder guessed it will take approx. 2-3 years to publish it (LfU-Gierig-Interview, 2021).

d) Availability across the EU

According to the Nordics Council of Ministers there are 808 incineration facilities in Europe, including hazardous and municipal waste incinerators (NordicCouncil, 2019).

The Confederation of European Waste-of-Energy Plants reported in 2018 that there are 492 waste to energy plants operating in Europe. This number does not include the hazardous waste incineration plants. In total, the 492 plants treated 96 million tonnes of waste in 2018 (CEWEP, 2018)¹⁰. Hazardous Waste Europe represents 155 hazardous waste treatment installations in Europe with a total treatment capacity of 4.6 million tonnes per year. These facilities however also include non-incineration processes such as biological treatment and landfills¹¹.

Another association, the European Union for Responsible Treatment of Special Waste – EURITS, shows on its homepage the availability of HWI across the EU (see Figure 12). Of course, this overview only includes member companies of this respective association.

Based on the overview it can be assumed, that HWI availability differs across Europe. This is in line with a stakeholder comment from Norway who reported that there is no HWI available in Norway, thus PFAS-based firefighting foam was sent to cement kilns (see also Appendix 2.2) (Equinor-Ystanes-Interview, 2021). Another stakeholder from the Netherlands indicated

¹⁰ Assuming that the difference between the 808 incineration facilities and the 492 waste to energy plants are hazardous waste incinerators it could be assumed, that there are 316 hazardous waste incinerators in Europe. However, the exact numbers are not known.

¹¹ Numbers are taken from the respective homepage, see <http://www.hazardouswasteurope.eu> accessed at 01.04.2021

ANNEX XV RESTRICTION REPORT – PFAS IN FIREFIGHTING FOAMS

that there would be no such incineration plant in the Netherlands. Neighbouring countries Belgium and Germany would have these (LEC-BrandweerBRZO-Submission, 2021). The figure below depicts the availability of HWI across the EU.



Figure 12. Availability of HWI across the EU taken from Eurits [homepage](#)

According to the German Federal Environmental Agency there are 29 hazardous waste incinerators in Germany with a total capacity of 1 520 490 million tonnes per year¹².

The WI BREF reported 121 hazardous waste incinerators in Europe in 2019 with a total capacity of 6.75 million tonnes of waste per year however the exact incineration conditions are unknown.

e) Costs¹³

According to Wood's report the cost to incinerate one PFAS-containing firefighting foam litre range between 0.3 – 1.5 €/l (Wood et al., 2020). This range is in accordance with the data gathered in the stakeholder engagement and literature review:

- On their website, the Rosenbauer Group reports a price of 200 – 400 €/m³ for the high temperature disposal of PFAS-containing firefighting foam, which corresponds to 0.2 – 0.4 €/l¹⁴.

¹² Numbers are taken from the respective homepage, see <https://www.umweltbundesamt.de/themen/abfall-ressourcen/entsorgung/thermische-behandlung#thermische-abfallbehandlung> accessed at 01.04.2021

¹³ The following assumptions have been considered: density of PFAS-containing firefighting foam is approximated to be 1 000 kg/m³ and exchange rate Euro to US dollar of around 1,2:1 (as of 01st of April 2021)

¹⁴ Numbers are taken from the respective homepage, see <https://www.rosenbauer.com/blog/en/proper-disposal-of-fire-fighting-foam> accessed at 01.04.2021

ANNEX XV RESTRICTION REPORT – PFAS IN FIREFIGHTING FOAMS

- Also, another company from Germany offers to take back foams for 1 – 2 €/l¹⁵.
- A stakeholder from Germany named a price of 700 €/t for the incineration of PFAS-containing firefighting foam which corresponds to 0.7 €/l (DUS-Valentin-Interview, 2021).
- Another stakeholder from Germany named a price of about 400 - 600 €/t, which corresponds to 0.4-0.6 €/l (LfU-Gierig-Interview, 2021).
- Another stakeholder from Germany named prices between 700 - 1 000 €/t, which corresponds to 0.7-1 €/l. The specification of the fluorine content before incineration is obligatory (Cornelsen-Interview, 2021).
- Higher prices are reported for Australia where € 2,000 per m³ are reported, which corresponds to 2 €/l¹⁶.

f) Additional information and available case studies

- According to one stakeholder from Germany, incineration plans often do not accept PFAS-based firefighting foams because of its foaming capacities (the liquid waste is fed into the combustion chamber through a nozzle) and the formation of HF-acid (corrodes the tiling). This could lead to the fact that the prices for PFAS firefighting foam incinerations will increase in the future (Cornelsen-Interview, 2021).
- One stakeholder from Germany stated that the only publicly accessible plant for a thermal treatment of waste containing PFCs in Bavaria is GSB - Sonderabfall-Entsorgung Bayern GmbH in Ebenhausen near Ingolstadt. The incineration plant consists of 2 lines with a total annual throughput of approximately 220 000 tons. In 2020, GSB thermally disposed of about 834 t of waste from the segment of extinguishing foam, extinguishing water, extinguishing agents, for which at least a PFC contamination could not be excluded in principle; only 23.88 t of foam extinguishing agents, extinguishing foam, extinguishing water contain a specific reference to PFC or PFT in the waste designation. Since the exhaust gas cleaning technology used in Ebenhausen consists, among other things, of various scrubber stages, which generally ensured a high separation of halogenated pollutant compounds such as HF, the emission of HF is far below the legal limit. Combustion temperatures average 1 080°C in the rotary kiln and 1 000°C in the afterburner chamber. Thermal destruction of components containing PFC/PFT can therefore be assumed with a high degree of probability (LfU-Gierig-Interview, 2021).
- A stakeholder from the Netherlands brought up the idea to set up consortia in different regions in Europe for the destruction of foam concentrates. Many parties (public and private) will soon have foam concentrates that may no longer be used. Tackling this together seems a good option for cost-efficient and environmentally friendly solutions (LEC-BrandweerBRZO-Submission, 2021).

2.2. Physical destruction – Incineration in cement kilns

a) Background

According to (Lundin and Jansson, 2017), cement kilns typically consist of a long cylinder of 50–150 meters in length, inclined slightly from the horizontal (3% to 4% gradient), which is rotated at about 1-4 revolutions per minute. Raw materials such as limestone, silica, alumina, and iron oxides are fed into the upper or “cold” end of the rotary kiln. The slope and rotation

¹⁵ Numbers are taken from the respective homepage, see <https://www.massong.com/de/1092/entsorgung-schaummittel.html> accessed at 01.04.2021

¹⁶ See comment on Rosenbauer homepage, see <https://www.rosenbauer.com/blog/en/proper-disposal-of-fire-fighting-foam> accessed at 01.04.2021

cause the materials to move toward the lower or “hot” end of the kiln. The kiln is fired at the lower end, where material temperatures reach 1 400°C–1 500°C. The fuel used to heat the rotary kiln has traditionally been coal, but lately different kinds of waste fractions have been used in some plants.

(Wang et al., 2015) published a paper in 2015 indicating, that the addition of calcium hydroxide can catalyze the defluorination process of PFASs. At temperatures of 900 °C this method showed high transformation rates, indicated by the formation of calcium fluoride. For PFOS a transformation rate of 90 % was achieved with even better results for PFHxS. PFOA and FOSA however only reached transformation ratios of around 50 % suggesting, that the functional group has an influence on the efficacy of the method. PTFE reached transformation ratios of 80 % already at a temperature of 400°C (Wang et al., 2015). Comparing this to the decomposition temperature of 500°C for PTFE, the calcium salts can lower the needed reaction temperature by 100°C. This research suggests that the addition of these salts to the incineration process can lower the formation of fluorinated gases.

According to data from Australia, the advantage of adding PFAS waste to the production of clinker in cement kilns, is that no extra energy is required to destroy the PFASs and additionally the quality of the clinker can be enhanced through the addition of fluorine (Holmes and Queensland, 2020b). Fluorinated substances react in the cement production process as mineralizers, which can promote the formation of a specific phase altering the thermodynamic equilibrium of reactions. Mineralizers are more efficient in the presence of a liquid phase and can contribute to the flux activity. Next to fluor other examples are: zinc, manganese, sulphur, among others (Cemex, 2013). The addition of fluoride has proven to increase the reactivity of clinker used in cement as well as reducing the amount of clinker needed. Typical fluorine addition rates are 0.2 % by weight of clinker to achieve mineralisation without adverse effects (Cooper, 2014).

Fluorine is often added in the form of calcium fluoride to the cement kiln but can also be added in the form of PFASs, however the calcium fluoride content should not be lower than 40%. The inclusion of calcium fluoride can decrease the burning temperature by 100 °C (Cemex, 2013). As limestone (calcium and magnesium carbonate) is an ingredient for the production of clinker PFASs could be added to form *in situ* calcium fluoride (CaF₂) in the cement kiln.

The preferred method of introduction of PFAS wastes is by blending the foam concentrate or any other liquid wastes into the alternative fuels (waste oils) to control and minimise the water content that would otherwise disturb the temperature of the burner flame. Solid wastes such as PFAS contaminated GAC and resins can also be introduced packaged in 20L buckets at a suitable point in the kiln as is currently done for clinical and drug wastes. Overall, it is considered that the use of cement kilns for PFAS destruction represents the best option based on the very large safety margins in the normal production conditions for complete destruction (calcium, high temperature, long residence times), permanent capture of the fluorine as inert, insoluble, non-toxic minerals, no need to modify kiln equipment, and no need for additional fuel/energy costs (Holmes and Queensland, 2020a).

b) Technical performance

The cement kiln generally operates at temperatures between 800 – 1 800 °C depending on which process step with a total residence time of about 25 minutes. At the hottest point the residence time at ~17 – 21 seconds at 1 800 °C (Holmes and Queensland, 2020b), which according to recent literature is hot enough to even destroy CF₄. As such, this technology can be used to effectively destroy PFASs and at the same time produce cement clinker.

The Queensland government in Australia has already conducted a trial run with a total fluorine input of 325kg/h from which 5kg/h was from PFASs. As a result, no PFASs and only minimal amounts of hydrogen fluoride could be detected after the burning process. The quality of the clinker was unaffected (Holmes and Queensland, 2020b).

ANNEX XV RESTRICTION REPORT – PFAS IN FIREFIGHTING FOAMS

Also, according to US-EPA, the temperature at which the cement kilns operate (usually around 1 400°C – 2 000 °C) allows for full destruction of PFAS compounds and the residence time (6-10 sec) is believed to be sufficient (Patterson and Dastgheib, 2020).

For conventional waste incinerators on average ~354 – 534 kWh/m³ of energy is needed at 1 100 °C for the burning of waste (Holmes and Queensland, 2020b). Maga et al. state an energy demand for the high temperature incineration of AFFF containing spent fire-extinguishing water at 1 100 °C of 1 312 kWh/m³ (Maga et al., 2021). This value is higher due to the added energy needed to vaporise the water.

c) Side products and emissions

According to stakeholder knowledge, cement kilns do not possess the same filter techniques as incinerators handling hazardous waste (HWI). This needs to be considered when emissions are discussed (DUS-Valentin-Interview, 2021). However, there are no standardized methods to monitor PFASs in exhaust air from incinerators as discussed above.

Other stakeholders also indicated, that there is no knowledge about a possible PFAS-contamination (or other fluorinated side products) of the end product (cement) (LASTFIRE-Interview, 2021).

Data from Australia however, indicate that when PFASs introduced to both the main burner and the calciner produced results of very high destruction efficiencies with no PFASs in flue gases and no change to the usual emissions of very low levels of HF in normal clinker production. A significant point to note is that the trial runs of destruction of PFASs at 5kg/hr (as F) were done with and without the input of aluminium smelter cell waste materials with fluorine throughput of 325kg/hr (as F). The destruction of the fluorine-containing (~15%) spent cell carbon and refractory waste has been common practice in cement kilns for decades with low HF emissions demonstrating the very high efficiency of fluorine capture by calcium and the failure of the carbon and fluorine to recombine into PFASs. The Cement Australia kiln at Gladstone is licensed to destroy up to 5kg/hr PFASs (as F) based on the maximum throughput rate in the trials (at ~€4.50/L). However, the other larger fluorine inputs with no significant HF or PFAS outputs suggest that greater throughputs of PFAS wastes could be destroyed just as effectively as the 5kg/hr (as F) in the licence (Holmes and Queensland, 2020a).

d) Availability across the EU

According to the best available techniques reference document for the production of cement, lime and magnesium oxide, there are 268 cement kilns in Europe. In 2004, 6.1 million tonnes of waste was used as fuel in cement kilns from which one million tonnes were hazardous waste. It is also stated that in 2007, 17% of fuels was sourced from waste (CLM-BREF, 2013).

German authorities are not aware that the incineration of PFAS-based foams in cement kilns are taking place in Germany (LASTFIRE-Interview, 2021, DUS-Valentin-Interview, 2021, LfU-Gierig-Interview, 2021). According to other stakeholders this is a developing field in the EU (LASTFIRE-Interview, 2021). Based on desktop search, also no other cases are reported. However, in Australia calcium catalysed destruction in cement kilns is currently best practice (Holmes, 2020) .

e) Costs

- One stakeholder indicated costs for incineration in cement kiln in Norway of 1-2\$/litre, what would correspond to 0.85 to 1.7 €/l (Equinor-Ystanes-Interview, 2021).
- Australian Stakeholder indicate a cost of €4.50/L (Holmes and Queensland, 2020a).

This price (EU-based) is comparable to the prices reported for HWIs (0.2 – 2 €/l).

f) Additional information and available case studies

- One stakeholder sent its waste to a cement kiln ([Norcem](#) in Brevik) in Norway, which uses temperatures of 2 000 °C. To his knowledge this would be the only waste disposal option in Norway, as most municipal waste incinerators operate at lower temperatures (800 °C) (Equinor-Ystanes-Interview, 2021).

2.3. Conclusion on the disposal techniques for PFAS-containing firefighting foam concentrates

The incineration of PFAS-containing firefighting foam concentrates is the most used disposal method. Literature indicates that waste incinerators at temperatures of 900 °C are able to destroy PFOS at more than 99%. A destruction efficiency of more than 99.97 % for fluorotelomers, chlorofluorocarbons and PTFE in conventional waste incineration was also reported. However, this process might not lead to the complete mineralisation of the PFASs i.e. the decomposition of the PFASs to CO₂, water, and hydrogen fluoride. At these temperatures short-chain fluorinated compounds such as CF₄, C₂F₆, CHF₃, C₂H₂F₂ and C₃F₈ can be formed and released to the air. Literature indicates that temperatures of at least 1 400 °C are needed to destroy CF₄ and as such completely mineralise the PFASs. Literature indicates, that 1 100 °C is sufficiently hot and feasible for the destruction of PFASs, however no study has provided quantitative results on possible fluorinated gas emissions.

The average cost is approximately 1€/l (range is 0.2-2 €/l) but the process requires high amounts of energy as the water needs to be vapourised. No actual data has been found that would indicate that the cost for incineration increased recently or will increase in the future. However, based on input of a stakeholder, the capacity is an issue for some hazardous waste incinerators, as not all of them can handle large amounts of liquid waste and foaming can cause issues, when it is stored intermediately with other liquid waste (WFVD and Peltzer, 2021). Also, according to another stakeholder from Germany, incineration plans often do not accept PFAS-based firefighting foam concentrates because of its foaming capacities (the liquid waste is fed into the combustion chamber through a nozzle) and the formation of HF-acid (corrodes the tiling). This could lead to the fact that the prices for PFAS firefighting foams incinerations will increase in the future (Cornelsen-Interview, 2021).

The co-incineration of PFAS waste in cement kilns seems to be a viable alternative to incineration in HWI, as these kilns reach temperatures of up to 1 800 °C with residence times of ~20 seconds. It has been shown that the addition of calcium fluoride can increase the quality of the clinker. Additionally, calcium salts can decrease the decomposition temperature of PFASs and increase the mineralisation rate by forming calcium fluoride. Through the addition of PFAS-containing waste to the clinker production in-situ calcium fluoride can be formed, which can increase the clinker quality and destroy the PFASs. The applicability of liquid PFAS firefighting foam concentrate in the cement kilns in the EU is more unclear. German authorities are not aware that the incineration of PFAS-based foams in cement kilns are taking place in Germany (DUS-Valentin-Interview, 2021, LfU-Gierig-Interview, 2021). One stakeholder from Norway indicated that his company sent PFAS-based firefighting foams to a cement kiln as there is no HWI available in Norway (Equinor-Ystanes-Interview, 2021). No costs have been reported for this case. In Australia calcium catalysed destruction in cement kilns is well established and currently best practice (Holmes, 2020). Australian Stakeholder indicate a cost of €4.50/L (Holmes and Queensland, 2020a).

However, stakeholders from Germany indicated, that cement kilns do not have the same filter techniques as HWIs (DUS-Valentin-Interview, 2021). In addition, stakeholders from Germany are concerned that the cement could also be contaminated (DUS-Valentin-Interview, 2021). However, data from Australia indicate no contamination of the cement and a very high destruction efficiencies with no PFASs in flue gases and no change to the usual emissions of very low levels of HF in normal clinker production (Holmes and Queensland, 2020a).

ANNEX XV RESTRICTION REPORT – PFAS IN FIREFIGHTING FOAMS

According to German federal environmental authorities the degree of destruction of PFASs (e.g. related to the input concentration) during incineration is not well understood. In general, there is still a need for research concerning the incineration of PFAS-containing wastes and thus also of PFAS firefighting foam concentrates (LANUV-Voland-Response, 2021).

The table below displays a comparison of the incineration techniques for PFAS-based firefighting foams in hazardous waste incinerators (HWI) and cement kilns.

Table 2. Comparison between incineration techniques for PFAS-based firefighting foams in hazardous waste incinerators (HWI) and cement kilns

	Incineration in HWI	Incineration in cement kilns
Background	Literature indicates that hazardous waste incinerators at temperatures of 1 100 °C are able to destroy PFASs at more than 99%.	The co-incineration of PFAS waste in cement kilns is a viable option as they reach temperatures of up to 1 800 °C with residence times of ~20 seconds.
Technical performance	According to current knowledge high temperature incineration in HWIs is an adequate technique to dispose, as PFASs are mineralised to more than 99%.	Data from Australia and the US seem to indicate that PFASs can be effectively mineralized in cement kilns.
Side products & Emissions	There are uncertainties concerning the emission of fluorinated substances, that could be produced when PFAS-based foams are incinerated. However, there is also no official standard to measure fluorinated substances in exhaust air. Currently, a standard for the measurement of fluorinated substances in exhaust air is being drafted.	One stakeholder from German indicates, that cement kilns are not having the same filter techniques as HWIs (DUS-Valentin-Interview 2021). In addition, also the cement could be contaminated (LANUV-Voland-Response 2021). However, data from Australia indicate no contamination of the cement and a very high destruction efficiencies with no PFASs in flue gases and no change to the usual emissions of very low levels of HF in normal clinker production (Holmes & Queensland 2020a)
Availability	The availability of HWI in Europe is different for each member state. Some countries do not have HWI and therefore need to transport their PFAS-based firefighting foam waste across borders.	According to the best available techniques reference document to produce cement, lime and magnesium oxide, there are 268 cement kilns in Europe.
Costs	0.2-2 €/l.	0.85 - 1.7 €/l

Appendix 3. Disposal of PFAS-contaminated fire run off and equipment cleaning water

A stakeholder survey and literature search performed in 2021 by Ramboll (Ramboll, 2021) provided the below information on the available techniques and costs for disposal of run-off waters and cleaning waters of firefighting foam equipment contaminated with PFASs.

3.1. Background

a) General treatment of PFAS-contaminated water

As described in Appendix 2, the current go-to technique for the disposal of PFAS-containing firefighting foam concentrates is incineration either in incineration plants and/or cement kilns. Incineration at high temperatures is a destructive technique and leads to the mineralisation of PFASs. For PFAS-containing fire run-off water (and any other PFAS contaminated water) the treatment methods and successive disposal methods can be distinguished between non-destructive and destructive techniques, whereby the final destruction of PFASs is in most cases also a succeeding incineration at high temperatures. Generally, it is not well known what happens to run-off water after a fire incident. Other fire run-off water from fires that happen outside facilities (e.g. municipal fires) is not well contained. This is also true for marine applications.

According to JOIFF, from a waste management perspective, treating foam concentrates and spent foam mixtures resulting from AFFF and fluoroprotein foams used in fire incidents is not possible using biological treatment processes. Conventional wastewater treatment plants will not breakdown non-biodegradable PFASs. Discharge of these wastes to sewer is therefore not an effective treatment (JOIFF, 2020).

In 2020, UBA together with Arcadis highlighted in a review article all available PFAS treatment technologies for groundwater and ranged them according to their practicality (UBA, 2020). In Figure 13 a visual summary of this overview is shown.

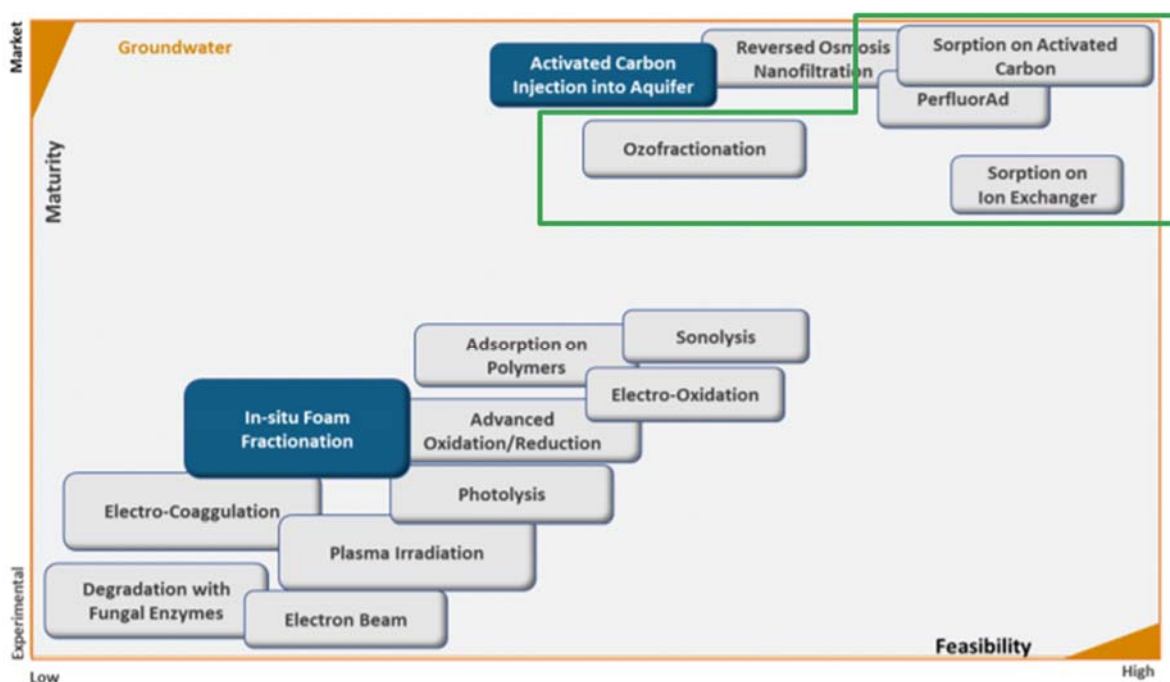

Figure 13. PFAS treatment technologies for water, ranged according to their practicality (taken from (UBA, 2020), green box added).

When PFAS treatment technologies for water are discussed, the volume of the water and the proportional PFAS-concentration need to be considered.

According to Horst et al., the current state of the practice for treating water contaminated with PFASs is to take extremely large volumes with low PFAS concentrations – typically in the part per trillion range (ppt; i.e., nanogram per litre [ng/L]); and convert it into much smaller volumes of high PFAS concentration, which can then be more economically treated using technologies attempting to destroy PFASs (Horst et al., 2020). In Figure 14, the conceptual impact of volume on the relevance of currently available non-destructive and destructive treatment approaches for PFAS contaminated water is shown.

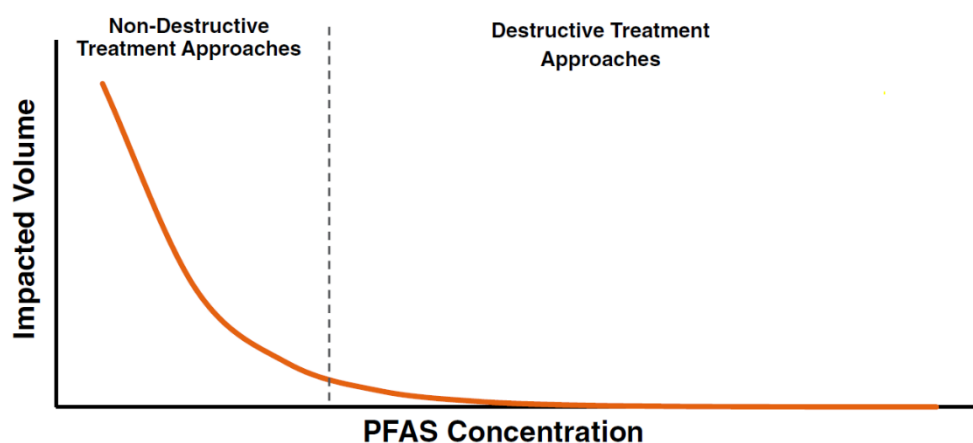

Figure 14. Conceptual impact of volume on the relevance of currently available non-destructive and destructive treatment approaches for PFAS contaminated water (taken from (Horst et al., 2020))

b) Treatment of fire run-off water and equipment cleaning water

In this report, only feasible and mature techniques for the treatment of fire run-off and cleaning water (shown in Figure 13 in the green box) have been analysed in detail.

For both PFAS-contaminated water types it is assumed that a rather high PFAS-concentration is to be expected. For example, PerfluorAd is designed for treating water containing PFAS concentrations greater than 0.3 µg/L (Ross et al., 2018).

Available techniques focussing on *in situ* techniques for groundwater are not considered (e.g. activated carbon injection into aquifer¹⁷), as they lack market maturity and are not compatible with both types of water (Concawe, 2020). In addition, those technique for which no references were available for treatment of fire-extinguishing waters or water with PFAS concentrations within the range of fire-extinguishing waters have been also not analysed. According to Concawe, for the following techniques there are no reported case studies regarding fire-extinguishing water treatment:

¹⁷ According to the national geographic society an aquifer is an underground layer of water-bearing permeable rock, rock fractures or unconsolidated materials (gravel, sand, or silt). Groundwater can be extracted using a water well. The study of water flow in aquifers and the characterization of aquifers is called hydrogeology. See <https://www.nationalgeographic.org/encyclopedia/aquifers>, accessed at 02.04.2021.

- Electrochemical degradation
- Sono-chemistry
- UV-radiation
- Plasma treatment

These non-destructive and destructive treatment techniques have therefore not been considered. The techniques have been analysed and updated based on current available literature (predominantly the ITRC-guideline (ITRC, 2020) and a review of water treatment systems for PFAS removal from Concawe (Concawe, 2020)) and finally stakeholder input.

According to UBA, the treatment of high AFFF-contaminated water poses a challenge. With the help of electrocoagulation and filtration, the water was prepared to such an extent that it could be treated by reverse osmosis (degree of purification approx. 99.9 %) (UBA, 2020).

c) Fate of fire run-off water

One stakeholder from Germany indicated, that PFAS-contaminated fire run-off waters mostly enter the environment (both via WWTP and directly) and (company-owned or municipal) WWTPs. Those who use chemical and physical treatment methods only are not suited to appropriately handle PFASs. In his opinion, a more suited way of handling the run-off water would be to collect it and store it in silos, where it can be treated. However, he observed this only in rare cases. Legally, in Germany, the run-off water after an incident is the responsibility of the company in which the fire occurred.

Based on an article by Cornelsen, three cases are to be distinguished when the fate of run-off water is to be characterised (Cornelsen, 2021):

1. If the fire event occurs on unsealed surfaces and/or grounds that do not have retention facilities or catchment areas for the extinguishing water, it must be assumed that the extinguishing water will infiltrate into the subsoil and possibly also into the groundwater (see Figure 15). Following infiltration, the contaminated soil material may have to be excavated and then disposed of (e.g. landfilled or incinerated), as shown in Figure 16 or the groundwater may have to be cleaned up over many years by means of a pump-and-treat measure (see Figure 16).
2. If the fire occurs on a paved area and the extinguishing water flows directly to the natural receiving water via the storm drain system, there is no possibility of intervention and the environmental impact is immediate. If, however, the water enters a sewage system, it might be possible to collect the PFAS-contaminated extinguishing water in the basin systems of the wastewater treatment plant. For this, the necessary space would have to be available, the "wave of pollutants" would have to be collected in a targeted manner and diverted into the buffer basins. If this is not possible - which is likely to be the more frequent case in practice - then it must be assumed that a significant share of the PFAS substances will pass through the wastewater treatment plants without any targeted treatment of these non-biodegradable substances.
3. Companies that are subject to the Extinguishing Water Retention Directive (LÖRüRL¹⁸) have bunding areas in which the extinguishing water can be temporarily stored. In the case of intermediate storage on site, various options can be selected for the subsequent handling of PFAS-contaminated extinguishing water.

¹⁸ LÖRüRL: Löschwasser-Rückhalte-Richtlinie" (in English: "Extinguishing Water Retention Guideline", an English translation is not available)

ANNEX XV RESTRICTION REPORT – PFAS IN FIREFIGHTING FOAMS

- a. Transport of the extinguishing water in silo vehicles to off-site water treatment plants: The so-called CP plants (chemical-physical water treatment plants) are mostly plants that accept process waters from trade and industry. In many cases, pre-treatment is carried out via a neutralization step prior to subsequent treatment in the public wastewater system. As a rule, such plants do not have a purposefully equipped process stage for the treatment of PFASs. Under such marginal conditions, a noticeable reduction of the PFAS load cannot be assumed.
- b. Transport of the extinguishing water in silo vehicles to incineration plants: domestic waste incineration plants (850°C), and hazardous waste or high-temperature incineration plants (1 100°C).
- c. On-site treatment of firefighting water with activated carbon (GAC). Theoretically conceivable and already implemented in some practical cases is the use of large-volume activated carbon filters for the treatment of PFAS-contaminated firefighting water. Depending on the respective PFAS contamination and the so-called organic and inorganic background contamination of the extinguishing water, it may not be possible to achieve the treatment objective at all or the costs resulting from the treatment may assume considerable dimensions.
- d. On-site treatment with the PerfluorAd process, in order to enable on-site treatment of PFAS-contaminated extinguishing water and also the use of activated carbon. For such and other applications, the PerfluorAd process was developed, which significantly reduces the content of PFASs as a pre-treatment stage, so that downstream process stages are significantly relieved and costs are reduced.

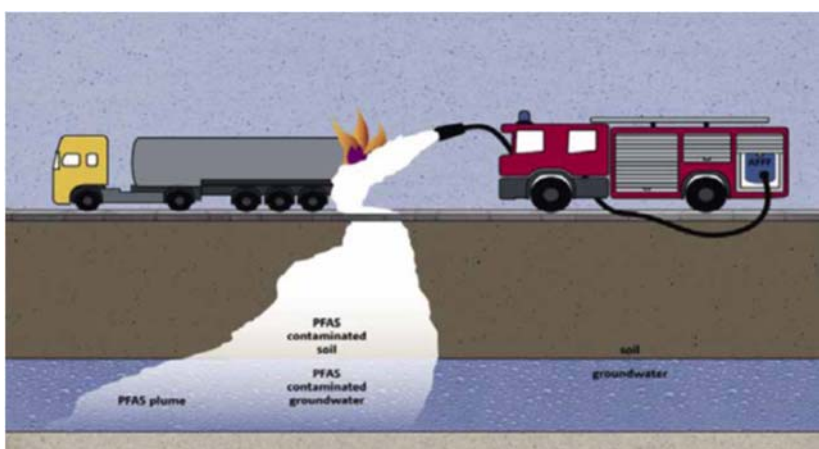

Figure 15. Outline of the entry of firefighting water into the subsurface if no retention facilities are available taken from (Cornelsen, 2021).

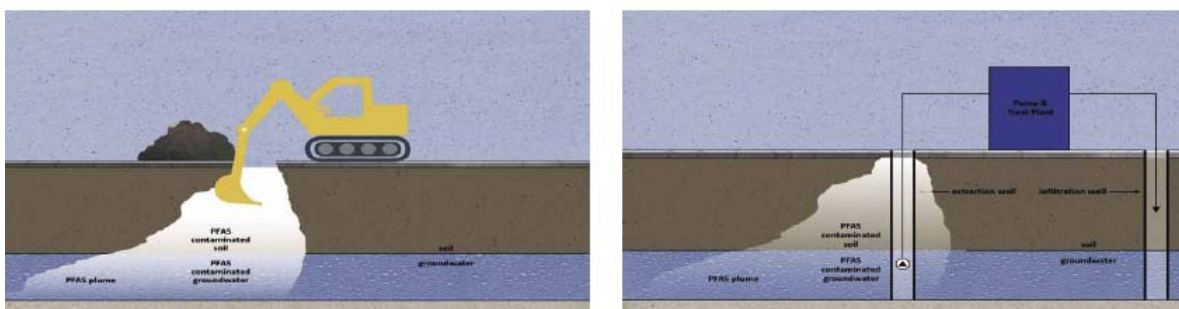

Figure 16. On the left, a representation of a soil excavation after successful infiltration of extinguishing water into the subsoil. On the right the pump and treat procedure is shown (Cornelsen, 2021).

Another stakeholder from Germany indicated that there is awareness about PFAS-contamination and that the water is treated with adequate responsibility. In Bavaria (and also Germany in general) fire water-containment measures are in place that need to follow the “Löschwasser-Rückhalte-Richtlinie” (LÖRÜRl in english: “Extinguishing Water Retention Guideline”, an English translation is not available). According to his knowledge the containment based on this guideline works (e.g. in industry plants), however, burning incidents involving large fires at facilities that are not covered by LÖRÜRi are more problematic. As an example, he named scrap tire storages (LfU-Gierig-Interview, 2021).

A stakeholder from the UK (LASTFIRE) informed that during and after fires the water run-off containment has a lower priority than other concerns, at least this has been the case historically. However, adequate containment is possible in an industrial context but not followed in reality or not easy or cost-effective to implement fully. In general, the containment of the water is not a problem for smaller fires, where the quantity of water is small, but can be for big fires. This is due to the fact that the bunding might fail due to the high amount of water, or the bunding may not be sized to take account the large amounts of water required. For the successful containment of PFAS-contaminated fire run-off waters the type and architecture of bunding areas is of highest importance and should be based on the amount of foam and water (e.g. in firefighting ponds) stored in the facility or the amount of fire and water required for a particular fire incident scenario (this information should be retained in the site emergency response plan). Today, the size of bunding area is typically calculated to have a holding capacity of 110 % of the largest tank, or where there are multiple tanks in a single bund 25 % of the total capacity of the tanks, whichever is the greater. There are primary, secondary, and tertiary bunding types. The primary containment is the tank itself. The secondary containment is the bund and the tertiary containment is beyond the bund but is designed to either contain a spill or direct the flow to a designed catchment area where it can be managed. Some of LASTFIRE’s members have taken adequate measures to prevent overflow of water, by having tertiary containment – often following reviews from the Buncefield incident¹⁹. For jetty areas, the containment is even harder, and water would usually go nowadays directly to the sea.

Another stakeholder from Germany explained that a complete containment of PFAS-containing run-off water is not in line with his real-life experience. In more detail, he explained that most of the run-off water is forfeit during the operations. Further, the stakeholder explained that there is almost always contamination of soil and water (DUS-Valentin-Interview, 2021).

3.2. Non-destructive method: Granular activated carbon (GAC) treatment

a) Background

The treatment of PFAS-contaminated water (or PFAS-containing firefighting foam) with activated carbon is based on the adsorption of a molecule on the surface of the activated carbon. This is facilitated by van-der-Waals interactions between the activated carbon and the target molecule. As these interactions can occur between any two molecules, a broad variety of compounds may be adsorbed, including some PFASs (mainly PFOS - see the technical performance paragraph below). This means that if a high concentration of other organic substances is present, the activated carbon becomes quickly fully loaded and unable

¹⁹ Large fire incident at the Buncefield oil storage depot in the UK. See description e.g. in the UK’s authorities report (COMAH) undated

to adsorb more molecules. As such, the PFASs compete with other contaminants for the adsorption on the activated carbon surface. The carbon is typically supplied as powdered activated carbon or as granulated activated carbon (GAC) carbon (US-EPA, 2020a, Analytik, 2019).

For the treatment with activated carbon the water to be treated is first filtered by a sand or multi-layered filter to remove non-solved contaminants, then sent through one or multiple activated carbon filters. By doing so, the solved contaminants including PFASs can adsorb to and saturate the surface of the activated carbon. If enough filters are installed in succession virtually all contaminants can be adsorbed out of the solution.

The active carbon spent is either sent to reactivation or high temperature incineration. During reactivation high temperatures are used to thermally desorb the contaminants, which allows the reuse of the activated carbon. The spent carbon is heated up to 800 °C for around 35 – 120 minutes. The conditions hereby range from a pyrolysis atmosphere (no oxygen) to a mild oxidative atmosphere (low oxygen) to restore the original carbon pore-structure. An afterburner with temperatures between 880 – 1 316 °C and a minimum residence time of 1 second is used to achieve a destruction rate of >99.99 % of the remaining contaminants. To what extent PFASs are destroyed under these conditions needs to be evaluated. Not all spent activated carbon can be reactivated. If the levels of organic halogens or metals is too high or the base carbon type is not suitable, a reactivation may not be possible. Alternatively, the activated carbon can also be incinerated via high temperature incineration. A reuse is therefore not possible (US-EPA, 2020a).

b) Technical performance

According to the ITRC-guideline, individual PFASs have different GAC loading capacities and corresponding breakthrough times (often defined as the number of bed volumes treated prior to detection in the effluent) (Eschauzier et al., 2012). GAC removal capacity for PFOS is greater than PFOA, but both can be effectively removed (McCleaf et al., 2017). In general, short-chain PFASs have lower GAC loading capacities and faster breakthrough times but could be effectively treated if changeout frequency is increased. There are currently no published studies on the effectiveness of GAC in removing cationic, zwitterionic, and anionic precursor compounds; however, a recent theoretical study suggests some precursors are unlikely to be effectively removed by GAC (Xiao et al., 2017) cited in (Ross et al., 2018).

Furthermore, also the organic background of the water needs to be considered as this also lowers the efficacy as other organic substances can also bind to the GAC (Ross et al., 2018). Under optimal conditions, i.e. using activated carbon with a high capacity potential, strongly adsorbing PFASs, few competitive contaminants, low organic levels and a high concentration in the to-be-treated water, loading rates of up to 0.1% can be achieved which corresponds to 1 g/kg of PFASs on the activated carbon. More realistic loading rates lie between 0,004 – 0,01 % (Analytik, 2019, Maga et al., 2021, LANUV, 2009).

According to Concawe, the US-EPA Health Advisory level for PFOS and PFOA (0.07 µg/L) as well as the proposed EU drinking water threshold of 0.1 µg/L for individual PFAS components (0.5 µg/L for total PFASs) are achievable by activated carbon treatment, but may require the use of several beds in series (Concawe, 2020). A PFAS removal rate of 99.9% has been documented for a fire-extinguishing water treated with granular activated carbon. However, this elimination rate has been determined after a very short operation time. The maximum operation time until material exhaustion has not been reported. While higher influent concentrations would lead to higher loadings of PFASs onto the carbon, the presence of numerous co-contaminants may lead to a reduction in the loading due to competitive sorption.

According to ITRC, most GAC full-scale treatment system case studies to date are based on treatment of PFOA and PFOS in the impacted drinking water sources. As such, limited information is available regarding the treatment of other PFASs. The full-scale drinking water systems demonstrate that PFOA and PFOS can be removed to below analytical detection limits until breakthrough occurs. Treatment of groundwater impacted with PFASs from an AFFF release area contaminated with PFASs such as fire training areas may require complex pre-treatment and more frequent change-outs (higher influent concentrations compared to influent for drinking water treatment systems) and higher operation and maintenance costs (ITRC, 2020).

c) Side products and emissions

The adsorption removal mechanism of GAC is not expected to transform precursors (for example, telomer alcohols) to terminal PFASs as would be the case when using advanced oxidation/reduction technology (ITRC, 2020).

Emission may however arise when the GAC is reactivated or incinerated. During the reactivation of GAC pyrolysis and gasification, conditions are applied to restore the surface of the carbon. Hereby the carbon is heated to temperatures around 800°C under either a non-reactive (inert; no oxygen; pyrolysis) to mildly oxidising (steam and CO₂; gasification) atmosphere. As the destruction of PFASs is achieved by completely oxidising all carbons of the PFAS molecule via the reaction with oxygen these processes may lead to different products. Especially under pyrolysis conditions where no oxygen is present, short-chain PFASs compounds and fluorinated gases may be formed.

Typically, the facilities are equipped with afterburners operating between 885 – 1 316 °C with a residence time of at least 1 seconds where all remaining contaminants are ought to be destroyed. As the formation of short-chain fluorinated gases under the aforementioned conditions is likely, it needs to be assessed whether the afterburner conditions can adequately destroy these compounds (US-EPA, 2020b).

According to (Ross et al., 2018) research indicates that some PFAAs can be destroyed on GAC surfaces at temperatures as low as 700 °C during the reactivation process. Destruction of volatized PFAAs (in the air phase) requires 1 100°C; however, thermal reactivation kilns normally include after-burners for air pollution control, and these usually operate at temperatures above 1 100 °C. Thus, a typical thermal reactivation process (800°C to 1 000°C reactivation temperature, plus an afterburner) seems to be well-suited for reactivating GAC that has exceeded its adsorption capacity for PFAAs. However, testing was not performed considering the wider range of PFASs, such as higher molecular weight (less volatile), polyfluorinated precursors reported to be associated with AFFF formulations. Data on whether these temperatures destroy all PFASs, including precursors potentially adsorbed to GAC, appears to be lacking.

One stakeholder indicated that the activated carbon is mostly imported from China, used, and then re-activated in the EU. Reactivation is more profitable than buying virgin products. To his knowledge, the reactivation takes place at temperatures around 600 °C, which could lead to incomplete destruction of PFASs and the formation of PFAS-side products. This could also lead to atmospheric deposition and contamination of soil and water (Cornelsen-Interview, 2021).

d) Availability across the EU

Temporary and permanent GAC systems can be rapidly deployed and require minimal operator attention, if intensive pre-treatment is not needed (ITRC, 2020). Currently, GAC is a widely used water treatment technology for the removal of PFOS and PFOA, and, to a lesser

extent, other PFAAs from water. Based on stakeholder input, activated carbon is mostly imported from China, used, and then re-activated in the EU. Reactivation is more profitable than buying virgin products (Cornelsen-Interview, 2021).

e) Costs

According to a recent report by the German Umweltbundesamt and Arcadis, the costs of treatment by GAC can vary considerably (UBA, 2020), e.g. from 0.40 - 2.30 €/m³ in a pilot test. In another case, costs of < 0.06 €/m³ to 0.68 €/m³ were found. Another study indicates the costs of sorption on activated carbon in the range of 0.24 €/m³ (10 µg/L PFASs in raw water) to 0.78 € (100 µg/L PFASs in raw water) (Q = 25 m³/h). This includes electrical energy, maintenance, and activated carbon consumption. Based on these numbers an average cost of 1.25 € per m³ PFAS-contaminated water is assumed, as calculated as the average of the respective highest reported cost value.

f) Additional information and available case studies

Maga et al 2021 published a life cycle assessment comparing three treatment options for spent AFFF. In this study the authors compared the incineration, the treatment with granulated activated carbon and the treatment with PerfluorAd and subsequent activated carbon with one another. The focus was on the environmental impacts of the individual treatment methods e.g. greenhouse gas potential, resource depletion and emission of ionising radiation. In this study the treatment with GAC showed adequate results. GAC treatment emits large amounts of ionising radiation as most GAC is sourced from fossil coal deposits (Analytik, 2019). Additionally GAC treatment can deplete the ozone layer as during the disposal of GAC many short-chain side products may arise (Maga et al., 2021).

3.3. Non-destructive method: Ion exchange (IX)

a) Background

According to Concawe, no references were available for IX treatment of fire-extinguishing waters or water with PFAS concentrations within the range of fire-extinguishing waters have been reported (Concawe, 2020). However, as IX might be used as a secondary treatment after for example PerfluorAd®, this method is shortly introduced as it is next to GAC the most established method.

According to ITRC, IX is an effective sorbent for other contaminants and has historically been used for a variety of water treatment applications (for example, nitrate, perchlorate, arsenic). To date, IX for PFAS removal from water is limited to *ex situ* applications (ITRC, 2020).

IX resin options for removal of PFASs include single-use and regenerable resins. Single-use resins are used until breakthrough occurs at a pre-established threshold and are then removed from the vessel and currently disposed of by high temperature incineration or by landfilling, where permitted. Regenerable resins are used until breakthrough but are then regenerated on site using a regenerant solution capable of returning the full exchange capacity to the resin. Temporary and permanent IX systems can be rapidly deployed.

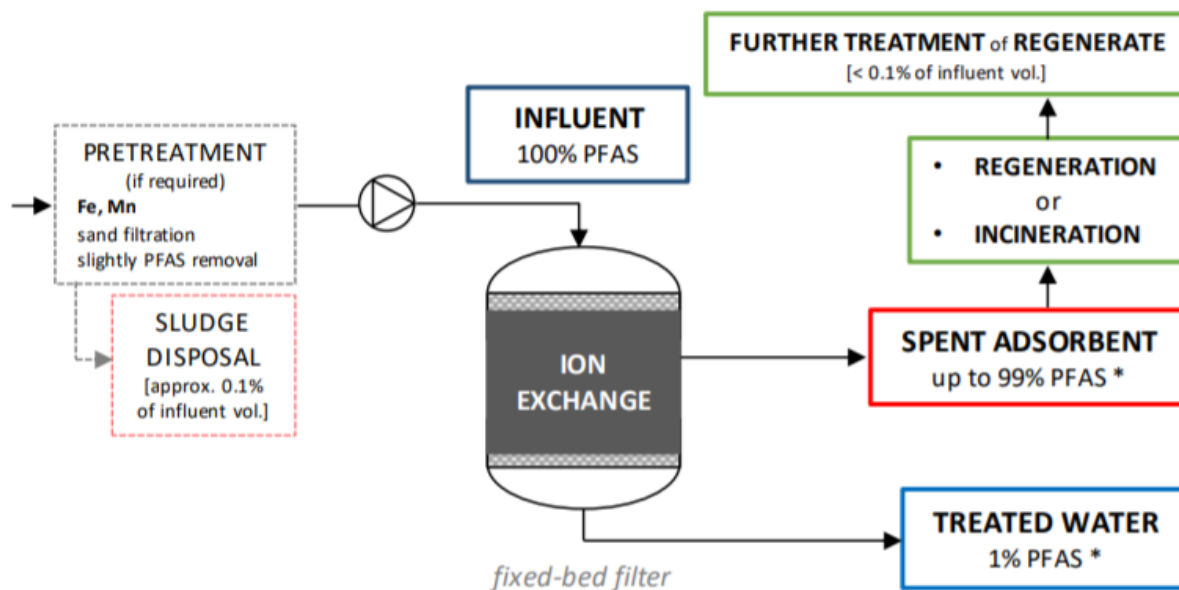

Figure 17. PFAS flow diagram for adsorption filtration with IEX /taken from (Concawe, 2020)).

There is a variety of IX resins available on the market. According to Dupont, the polymer matrix of an ion exchange resin generally falls into two categories – gel or macroporous. A number of resins, both gel and macroporous type, developed for this market have similar chemical properties to allow for improved PFAS selectivity (Dupont, 2020).

b) Technical performance

According to the Concawe report (Concawe 2020) and the literature cited therein, various anion exchangers have been identified with a higher adsorption capacity towards PFASs than activated carbons. The selective PFAS removal from contaminated waters by anion exchange works at both high PFAS concentrations of hundreds of mg/L as well as at low concentrations in the ng/L and µg/L range. Similar to the adsorption onto activated carbon, the affinity of per- and polyfluoroalkyl sulfonates (PFSA) to ion exchangers is higher than those of per- and polyfluoroalkyl carboxylates (PFCA), and long-chain PFASs are absorbed preferably compared to short-chain PFASs. Treating groundwater, operation times up to 80 000 to 150 000 BV²⁰ can be reached for the elimination of long-chain PFASs. However, retention of short-chain PFASs is lower and breakthrough starts at 10 000 to 30 000 BV. For ion exchange, the sorption kinetics for PFASs are relatively slow but it is still faster than adsorption on activated carbon. Fast sorption kinetics will result in a smaller filter geometry and therefore less investment costs. US and EU threshold value for PFOS and PFOA (0.07 to 0.1 µg/L) are achievable using ion exchange resins.

c) Availability across the EU

According to ITRC, Ion exchange technology has been used in the US since the late 1930s for common water treatment processes like softening, demineralization, and selective contaminant removal. The development and use of selective resins for PFAS removal is relatively new but already well established. As of 2019, a limited number of regenerable IX systems have been installed in full-scale applications after successful pilot testing. Collection

²⁰ BV: bed volumes. In Concawe report the bed volume is the throughput of water that can be treated with a filtering medium until the breakthrough of the target PFAS compound(s).

of data on longer term treatment and on-site regeneration of the IX resin is ongoing at a case study site.

Also, according to UBA, groundwater purification by means of ion exchangers is a common and widely used process. However, they have only rarely been used in Germany for the remediation of PFAS contamination. Accordingly, only limited experience is available from remediation on a technical scale. Due to the growing experience with this process, especially in Australia, it can be expected that ion exchangers will be used more frequently in the future (UBA, 2020).

d) Side products and emission

In single-use applications, the IX resins are loaded with the PFASs and must be disposed for final destruction using high temperature incineration in HWI. It is noted that the IX resin vendors normally cooperate with specialist licensed waste handling companies that can organize the resin disposal (ITRC, 2020). Treatment costs might be lower when regenerating and re-using the ion exchanger resin. The binding of PFASs to ion exchangers is not only affected by the intended electrostatic interactions, but also by hydrophobic interactions with the backbone of the ion exchanger (UBA, 2020). Therefore, for a sufficient regeneration the use of an organic solvent such as methanol or ethanol is required adding to the complexity and cost. Also, these solvents would also need to be treated (ITRC, 2020).

e) Costs

The material costs of ion exchangers are about 12 €/kg and thus about 3 times higher than the average costs of activated carbon. Using the above information, it is estimated that groundwater treatment costs for long-chain PFASs of 0.05 to 0.1 € per m³ PFAS-contaminated water and for short-chain PFASs of 0.25 to 0.8 € per m³ PFAS-contaminated water respectively (Concawe, 2020). Based on these numbers an average cost of 0.45 € per m³ PFAS-contaminated water (for both long- and short-chain PFASs) is assumed.

According to UBA, the total costs for ion exchangers compete with the costs for the sorption of the PFASs on activated carbon. Even if the activated carbon process is less efficient and requires more sorption material, in the end it could be cheaper (UBA, 2020). However, there are no actual costs cited.

3.4. Non-destructive method: Precipitation - PerfluorAd®

a) Background

The principle behind the precipitation of PFASs is to introduce a molecule which can bind to the charged moiety (e.g. sulfonic acids). By doing so, the PFAS molecule interacts with added cations via electrostatic and intermolecular interaction, becomes insoluble and precipitates. The affinity to bind to this cation depends on many factors such as molar mass, functional groups, amount of charges etc. The precipitate can be mechanically filtered and be removed from the PFAS solution.

Cornelsen Umwelttechnologie GmbH is a specialist supplier of systems, technologies, products and services for the remediation, water filtration and landfill leachate sectors located in Essen, Germany. Cornelsen together with the Fraunhofer-Institute UMSICHT developed a technology based on this principle called PerfluorAd® (in the following called PerfluorAd). At Cornelsen's home webpage detailed information is accessible (in German and English). In addition to that, the technique is also described in scientific literature and Mr. Cornelsen has also been interviewed by Ramboll. According to Mr. Cornelsen, the technique is used mainly for highly PFAS-contaminated water (also with an optional organic background level). Highly PFAS-

contaminated water means here values in the higher range of $\mu\text{g/l}$. PFASs can be removed from contaminated waters with efficacies of 80-90 % and can be then subjected to further treatment like GAC and ion exchange. In Figure 18 a schematic overview of an GAC with PerfluorAd Pre-treatment stage is given.

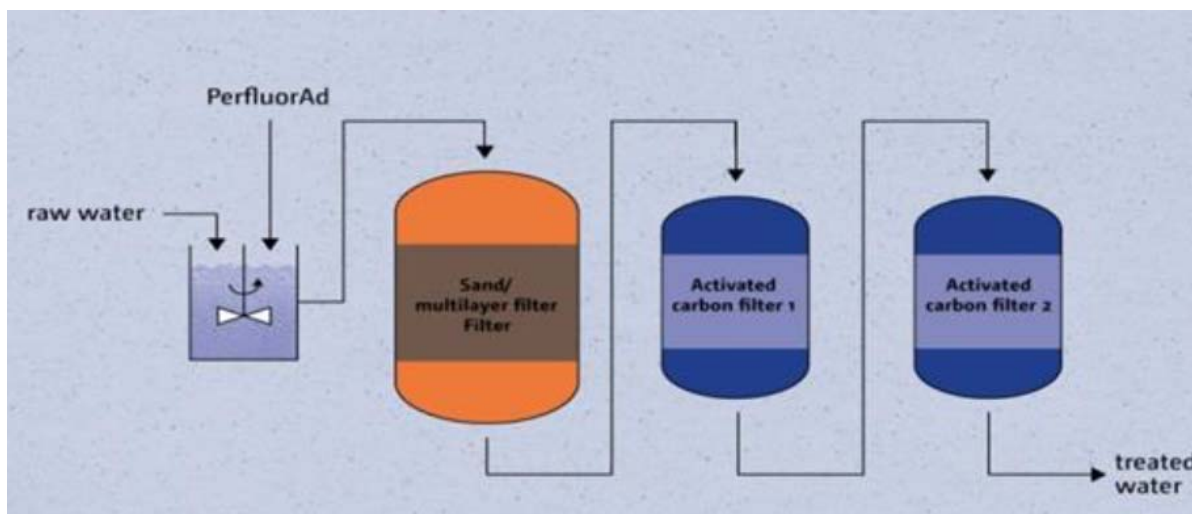

Figure 18. Schematic overview of an Activated Carbon Plant (GAC) with PerfluorAd Pre-treatment Stage (taken from Cornelsen)

Highly PFAS-contaminated water can be for example fire run-off water or water from PFAS-related cleaning from technical equipment.

According to the stakeholder, low PFAS-contaminated water is not the primary subject to PerfluorAd. Therefore, most groundwater contamination is not suited to be treated by PerfluorAd. GAC and techniques using ion exchanger (and combinations) are better suited. Also, AFFF-concentrates are not suited for PerfluorAd and would, theoretically, need to be diluted because the concentration of PFAS- and non-fluoride organic surfactants would be too high. Direct incineration is the preferred option for the PFAS firefighting foam concentrates (Cornelsen-Interview, 2021).

PerfluorAd changes the solution equilibrium of PFASs in water. The reaction modes are precipitation and flocculation, mainly based on ion ionic interaction. The reaction is non-destructive, meaning that the chemical composition of the PFAS substance is not changed. In addition to PFASs, PerfluorAd also removes other non-fluorinated surfactants which are present with PFAS-surfactants in AFFF-products (Cornelsen-Interview, 2021).

A cationic compound mix consisting of different di- or triethanolamine quats (TEA) based vegetable fatty acids is added to the PFAS-containing water. These fatty acids have the advantage of being biodegradable and synthesised from sustainable sources (Maga et al. 2021). The charged PFAS molecules interact with the positively charged "head" of the ethanolamine quats and precipitate (see Figure 19). The combination ratio thereby is not always 1:1.

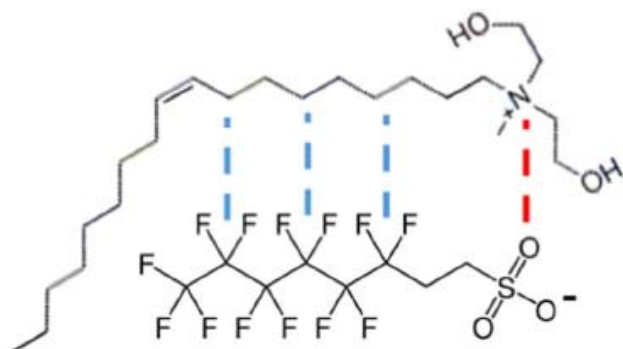

Figure 19. The interaction between the PFAS molecule (below shown for the example of 6:2 FTS) and the added cation (taken from Maga et al 2021)

Depending on the PFAS-concentration, precipitant is added and is as such scalable. After precipitation the precipitated flakes can be filtered out (sand filter) and sent to high temperature incineration.

b) Technical performance

In general, the removal efficiency of PerfluorAd is depending on the chain length and the polarity of the PFASs. The long-chain sulfonic acids (PFASs) show the best removal efficacy. The same effect is also observed when using GAC (Cornelsen-Interview, 2021).

The PerfluorAd precipitating agent is specific for charged molecules so that in a recent experiment with diluted a 1% diluted AFFF only 1.1 % of the dissolved organic carbon was precipitated. According to Cornelsen, in the dosing range between 1.5 and 2.5 g/l PerfluorAd, elimination rates of approx. 99% for total PFASs (without "Capstones") are achieved. With this dosage, an elimination rate of approx. 80% is achieved for "Capstones" and 87% for organically bound fluorine (see Figure 20) (Cornelsen 2021)

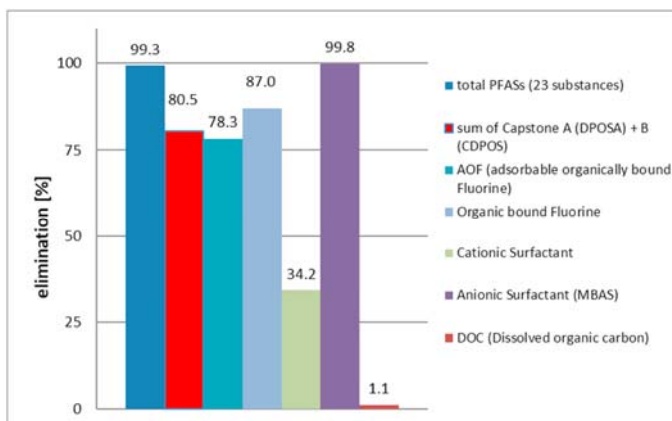

Figure 20. Elimination rates for different parameters [%] at an optimal dosing rate of 2.0 g/l PerfluorAd applied on a 1% AFFF premix (taken from (Cornelsen 2021))

The dosage ranges from 25 mg/L to 2 g/L and can be optimised for different PFAS concentrations and the water matrix to obtain higher elimination rates. The process is primarily designed for treating water containing PFAS concentrations greater than 0.3 µg/L (Ross et al., 2018). PerfluorAd is used as the first PFAS treatment step within a treatment train. Thus, this process is not intended to achieve final target threshold values (e.g. 0.1 µg/L) as it is recognised that a further treatment step is required (Ross et al., 2018). The time to

precipitate the containing PFAS ranges from 10 – 30 minutes depending on the water matrix and containing pollutants (WVF, 2019).

These values represent optimal removal efficiencies and are however dependent on the correct amount of PerfluorAd based on the PFAS-concentration in the solution. Too high or too low amounts of PerfluorAd can negatively affect the efficiency of the process. Additionally, the precipitate shows a higher selectivity toward long-chain PFASs and has lower efficiencies for short-chain PFASs (Maga et al., 2021, Cornelsen, 2020).

The precipitate (sludge) can then be treated by high temperature incineration. The advantage with this is, that only the precipitated PFASs including cationic counterpart need to be incinerated instead of incineration the whole AFFF solution/ run-off water, including its water content. This decrease in volume of PFAS-contaminated water to be incinerated is likely to lead to the reduction of the overall cost for the treatment of the PFAS-contaminated water. However, this also depends on the maximum residual PFAS concentration which needs to be achieved.

c) Side products and emissions

The precipitation techniques cannot destroy or mineralise any PFASs. It instead enables the removal of the PFASs from a water solution by precipitation. According to Martin Cornelsen, measurements and calculations of mass balances show that there are no side reactions or loss of reaction partners (PFASs & PerfluorAd substance). The incineration of the precipitate or spent activated carbon may however lead to the formation of products of incomplete combustion.

d) Availability across the EU

The active ingredient is produced in the EU and according to Mr. Cornelsen, there are no limitations regarding its availability.

e) Costs

The substance costs around 10-25 €/kg, depending on the purchased quantity. However, the active ingredient is not the only limitation criteria. According to Mr. Cornelsen, the costs are more related to the manpower and material (including for example the activated carbon). For the entire PerfluorAd/activated carbon system, operating costs (depending on the activated carbon used) amounted to < 0.055 - 0.68 € per m³ of treated water, of which approx. 0.04 €/m³ is attributable to PerfluorAd (UBA, 2020).

f) Additional information and available case studies

- Maga et al 2021 published a life cycle assessment comparing three treatment options for spent AFFF. In this study the authors compared (1) the incineration, (2) the treatment with granulated activated carbon and (3) the treatment with PerfluorAd and subsequent activated carbon. The focus was on the environmental impacts of the individual treatment methods e.g. greenhouse gas potential, resource depletion and emission of ionising radiation. In this study, the PerfluorAd technology with subsequent active carbon treatment performed the best of the analysed treatment methods in nearly all investigated impact categories.
- Remediation of PFAS-contaminated groundwater under the Nuremberg Airport Fire Department's firefighting training area: the groundwater underneath the firefighting training area at Nuremberg Airport has been contaminated by PFASs due to the use of fluorine-containing firefighting agents over many years. A mobile groundwater

remediation system based on the PerfluorAd principle was made available, thereby remediating the groundwater. The initial PFAS concentration in the groundwater was more than 600 µg/l for the sum of the PFASs. With the PerfluorAd treatment alone, the PFAS load is reduced to 41 µg/l (i.e., by 93.5%). After the final activated carbon stage (GAC for granulated activated carbon), PFAS contamination is no longer measurable.

3.5. Non-destructive method: foam fractionation and ozofractionation

a) Background

Foam fractionation and ozofractionation are technologies that take advantage of the foam-forming properties of PFASs. The process selectively separates PFASs from water by injecting compressed air (foam fractionation) or ozone (ozone fractionation) into the water in the form of air bubbles. PFAS surfactants adhere to the bubble walls and are thus transported to the surface (see Figure 21). The PFAS-enriched foam is collected at the water surface for further destruction-based treatment. The treated water typically goes through a further treatment step (e.g. GAC)(Concawe, 2020).

In the case of ozofractionation, precursors (also PFASs) are transformed to the perfluoroalkyl carboxylic (PFAA) and sulfonic acids (PFSA). Those PFASs remain in the system and are concentrated and discharged in the gas bubbles. Ozone can also promote the degradation of accompanying organic contaminants. Due to the small size of the gas bubbles (diameter < 200 µm), the total mass of the ozone bubbles has a large gas-water interface. At the surface of the water phase in the reactor, the PFASs are therefore concentrated in a small, separable volume.

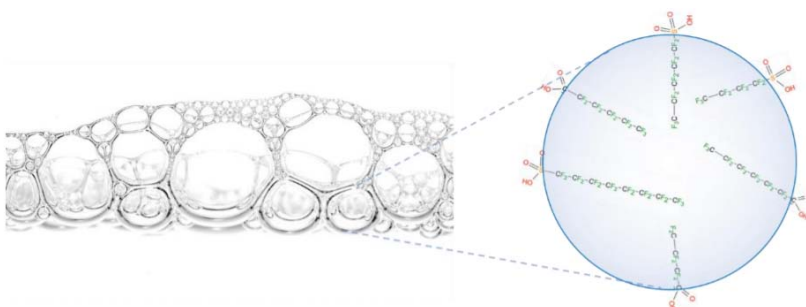

Figure 21. Illustrative Concept of foam fractionation (taken from (UBA, 2020))

b) Technical performance

On a technical scale (Figure 22), the ozone fractionation consists of several reactors connected in series with continuous flow, into which ozone is introduced as bubbles. The PFAS concentrate as highly PFAS-contaminated foam floats on the liquid surface of the reactors. From the surface, the bubbles get extracted via vacuum, are further concentrated and can be fed to a further destructive treatment. The volume of the concentrate is 0.5 – 2 % of the inflow volume. The ozofractionation process alone usually cannot achieve the required PFAS concentrations and a supplementary process stage is needed. The gas phase is released into the atmosphere via an activated carbon adsorber. As a rule, the last process stage of the water phase is an activated carbon adsorber to capture the remaining PFAS residues to achieve the required discharge values. If impurities are still present, the process can be extended by further process stages if required.

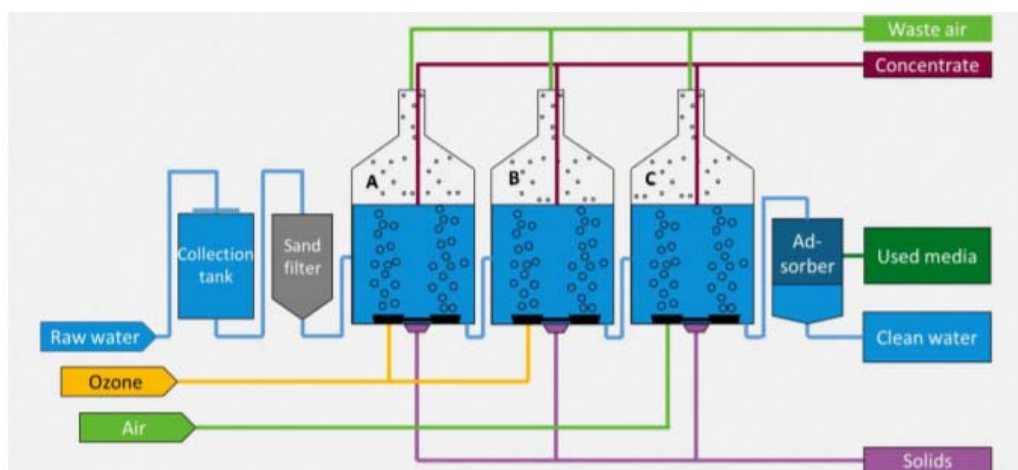

Figure 22. Ozofractionation process concept (taken from (UBA, 2020)).

For long-chain PFASs such as PFOS and PFOA, a purification level of 99.9 % has been achieved (Evocra, 2017). For the ozofractionation stages alone, a purification level of > 98.7 % was always achieved. The short-chain PFASs can be removed better with ozone than with air (Ross et al., 2018). The results further indicate that, for PFAS concentration levels below 0.3 µg/L, high elimination down to a few ng/L could still be achieved (Evocra, 2017).

Similar to the precipitation with PerfluorAd, ozonofractionation has an economic advantage at very high PFAS concentrations (which would be the case in PFAS-contaminated fire run-off water and water from cleaning processes). The process is not only suitable for the treatment of water, but also for sludge with a solids content of up to 20 %. The fractionation reactors separate the liquid from the solid phase. Small particles get into the foam concentrate and are removed with it. Coarse particles sediment at the bottom of the reactors and are removed from there. Unlike many other processes, the degradation of an accompanying organic contamination does not significantly affect the PFAS removal level. The disadvantage is that a waste product (PFAS zone foam concentrate) is produced which must be disposed of separately (UBA, 2020).

Based on desktop research, it seems that the ozone is introduced to the reaction by adding of "Arcadis Solvent V171". The mixture has the following hazard statements: H227 (combustible liquid), H319 (causes serious eye irritation), H336 (may cause drowsiness or dizziness) and AUH019 (May form explosive peroxides) from (Arcadis, 2019)). AUH019 is an Australian-specific H-statement and equals the European EUH019 (also may form explosive peroxides).

Foam fractionation uses compressed air and is commercialized by the Australian company OPEC systems, allowing a continuous on-site treatment process in a containerized system. The treatment system is called Surface Active Foam Fractionation (SAFF). The operation mode of the system can be adjusted to manage a broad range of total detectable PFAS influent concentrations (0.1 to 100 000 µg/L). The residence time per reactor vessel ranges from 5 to 30 minutes. PFAS-enriched foam is removed with a vacuum extraction system (Concawe, 2020).

According to the Concawe report and literature cited therein, for both methods, depending on influent concentrations, the US-EPA Health Advisory levels for PFOS and PFOA (0.07 µg/L) as well as the proposed EU drinking water threshold of 0.1 µg/L for individual PFAS compounds (0.5 µg/L for total PFASs) are achievable without additional treatment steps. However, both technologies usually include a final treatment step, resulting in removal efficiencies of 99.9%

to 99.99%. Very high influent concentrations might be managed via a multi-stage fractionation process (Concawe, 2020).

c) Side products and emission

Foam fractionation and ozofractionation are non-destructive techniques. In the case of ozofractionation, the PFAS-ozone bubbles are drawn off (vacuum extraction) and further concentrated and can be fed to a further destructive treatment. The volume of the concentrate is 0.5 - 2 % of the inflow volume (UBA, 2020).

d) Availability across the EU

According to UBA and Arcadis, the ozofractionation process has already been tested on a technical scale in Australia. According to the available documentation, the process appears to be ready for the market. However, as it is generally the case with newest technologies, there is a lack of supplier-independent studies to verify its effectiveness. The supplier in Australia is a company called Evocra²¹, which signed a strategic exclusive agreement in 2019 with Arcadis.

Foam fractionation is not available at technical scale. However, limited field trials show promising results (OPEC-Systems, 2020).

e) Costs

Ozofractionation is a relatively complex technology which operating costs are significantly higher than those of alternative market-ready technologies (e.g. GAC) but this cannot be assessed in details due to lacking data (UBA, 2020).

f) Additional information and available case studies

The technique has been used in several cases in Australia and one in the UK, this involved (based on the results of the desktop search within this project):

- A large-scale implementation of ozofractionation at an airport in Australia using a NF unit for polishing to treat PFAS affected surface water and wastewater achieved a removal efficiency of 97% for the sum of 28 PFASs with inlet concentrations of 100 to 5 400 µg/L²².
- Water remediation at a fire training site²³
- 22 000 liters of PFAS firefighting foam concentrate escaped from a failed deluge system within an airport hangar²⁴.
- Contamination stemming from an airport in the UK (Guernsey island)²⁵

²¹ See Evocra 's internet site <https://evocra.com.au/case-studies/pfas>, last accessed 01.04.2021

²² See <https://www.arcadis.com/en-au/knowledge-hub/blog/australia/jason-lagowski/2020/its-a-gas-ozofractionation-as-an-effective-pfas-treatment-method>, last accessed 01.04.2021

²³ See presentation at <http://adelaide2019.cleanupconference.com/wp-content/uploads/2019/09/T31e.pdf>, last accessed 01.04.2021

²⁴ See presentation <https://www.arcadis.com/en/projects/australia/for-translation-aus/pfas-remediation-for-australian-aviation-client>, last accessed 01.04.2021

²⁵ See presentation <https://www.arcadis.com/en/projects/europe/united-kingdom/protecting-guernseys-water-from-pfass>, last accessed 01.04.2021

3.6. Destructive approaches: incineration

The details of PFAS waste incineration techniques are explained in Appendix 2 and are in principle applicable also to PFAS-contaminated firewater run-offs and equipment cleaning water. However, as the concentration of PFASs in this waste is considerably lower than in firefighting foam concentrates, literature indicates that in some cases non-destructive techniques are used to lower the to be incinerated volume and related costs.

3.7. Conclusion on the disposal techniques of PFAS-contaminated fire run off and equipment cleaning water

The following conclusions can be made for available disposal options for PFAS-contaminated (fire run-off and cleaning) water:

- Fire run-off and equipment cleaning water are usually highly PFAS-contaminated compared to, for example, groundwater contaminations. Based on this, certain remediation techniques for groundwater can be used also for run-off and cleaning water.
- GAC can also be used for all PFAS-contaminated run-off and cleaning water. However, the efficiency is lower for PFAAs (carboxylic acid) in general and short-chain PFASs. For other PFASs (e.g. zwitterionic) no data is available. One stakeholder indicated that when GAC is reactivated (using 800 °C), PFASs could be emitted (Cornelsen-Interview, 2021).
- Ion exchange (IX) is generally suited for PFAS-contaminated run-off and cleaning water. However, no case studies are available. Based on the type of PFASs, various IX-matrices are available. IX is believed to be four times more expensive than GAC, when only the material is considered. According to UBA, the total costs for ion exchangers compete with the costs for the sorption of the PFASs on activated carbon. Even if the activated carbon process is less efficient and requires more sorption material, in the end it could be cheaper (UBA 2020). However, there are no actual costs cited.
- GAC and IX are generally based on column beds to which PFASs adsorb. To achieve certain PFAS-levels several beds in series must be used. With both techniques proposed EU drinking water threshold of 0.1 µg/L (0.001 ppm) for individual PFAS components (0.5 µg/L for total PFASs) are achievable but may require the use of several beds in series. The material cost for GAC is around 0,41 – 3,68 €/kg. According to a recent report by the German Umweltbundesamt and Arcadis, the cost for the remediation can vary considerably (UBA, 2020), for example from 0.40 - 2.30 €/m³ in a pilot test. In another case, costs of < 0.06 €/m³ to 0.68 €/m³ were found. Another study indicates the costs of sorption on activated carbon in the range of 0.24 €/m³ (10 µg/L PFASs in raw water) to 0.78 € (100 µg/L PFASs in raw water) (Q = 25 m³/h). This includes electrical energy, maintenance, and activated carbon consumption. Based on these numbers an average cost of 0.85 € per m³ PFAS-contaminated water is assumed, as calculated as the average of the respective cost values.
- For IX, material cost is about 12 €/kg and treatment costs for long-chain PFASs of 0.05 to 0.1 €/m³ and for short-chain PFASs of 0.25 to 0.8 €/m³ respectively. Based on these numbers an average cost of 0.45 € per m³ PFAS-contaminated water (for both long- and short-chain PFASs) is assumed.
- To minimize the load (and therefore costs) of GAC/IX, precipitating agents like PerfluorAd® can be used. The active ingredient changes the solubility of PFASs. PFAS-PerfluorAd sludge can be incinerated. The water then is then further treated with

ANNEX XV RESTRICTION REPORT – PFAS IN FIREFIGHTING FOAMS

GAC/IX (treatment train). For the entire PerfluorAd/activated carbon system, operating costs (depending on the activated carbon used) amounted to < 0.055 - 0.68 € per m³ of treated water, of which approx. 0.04 €/m³ is attributable to PerfluorAd.

- Ozonofraction generates ozone bubbles which are considerably smaller than regular air-bubbles, where PFASs remain at the gas-water interface. The bubbles containing the PFASs can then be physically removed. The water is further treated with GAC/IX (treatment train). For PFAS concentration levels below 0.3 µg/L, high elimination down to a few ng/L could still be achieved. No information is available for the costs of this technique, however, ozonofraction is a complex technology whose operating costs are significantly higher than those of alternative market-ready technologies (e.g. GAC), but this cannot be assessed due to lacking data.
- PFAS-contaminated fire run off and cleaning water can also be directly incinerated. The cost for the disposal of 1 liter of PFAS-based AFFF are currently in the range of 0.2-2 €/l (around 200-2 000 €/m³), it can be assumed that the same costs apply to fire run-off water.
- Based on the available data, the direct incineration of PFAS-contaminated run-off water would be the most expensive disposal alternative (200-2 000 €/m³). According to (UBA, 2020) GAC and IX are comparable in costs (although material costs differ). For GAC, an average cost of 0.85 € per m³ of PFAS-contaminated water is assumed (three projects considered). For IX an average cost of 0.45 € per m³ PFAS-contaminated water (for both long- and short-chain PFASs) is assumed.
- Based on available data, the combination of PerfluorAd and GAC is the cheapest technique with an average reported cost of < 0.055 - 0.68 € per m³ of treated water, of which approx. 0.04 €/m³ is attributable to the PerfluorAd. The cost depends on the activated carbon used. Based on these numbers an average cost of **0.37 € per m³ PFAS-contaminated water** (for both long- and short-chain PFASs) is assumed.

In Annex section E.4 a summary table of the disposal techniques for PFAS firefighting foam concentrate, fire run-off and equipment cleaning water is provided.

Appendix 4. Detailed foam transition timescales (from industry) (source: Wood 2020)

The following table has been provided as stakeholder input by an industrial end user and is reproduced in this report with kind permission from that stakeholder. Note that the table reflects the views of that stakeholder. Conclusions of the authors of this study are presented in the main body of the report.

Key

	Research/Testing
	Modification to Standards, legislation etc
	Development of Guidance/data gathering
	Site Specific Tasks
	Other
	Milestones

Task	Notes	t-4	t-3	t-2	t-1	T	t+1	t+2	t+3	t+4	t+5	t+6	t+7	t+8	t+9	t+10
Formal Start of Transition and Introduction of Legislation	Assumed start date. If delayed, then subsequent phases would be delayed also															
Manufacturer development of FF products	Ongoing/continuous															
Validation of performance based small scale acceptance testing - tanks	Already done by LASTFIRE for tanks, using conventional application methods															
Validation of performance based small scale acceptance testing - aviation	Some work done by aviation authorities but needs greater full acceptance.															

ANNEX XV RESTRICTION REPORT – PFAS IN FIREFIGHTING FOAMS

Task	Notes	t-4	t-3	t-2	t-1	T	t+1	t+2	t+3	t+4	t+5	t+6	t+7	t+8	t+9	t+10
Validation of performance based small scale acceptance testing - general purpose use (municipal brigades)	Effectively already completed as EN 1568 performance based															
Establishment of formulations and effects of different foam types	PERF work in progress for oil industry, but relevant to all sectors															
Acceptability criteria for PFASs, etc	By regulator															
Full environmental effects data for new concentrates and acceptability criteria	Regulator needs to be precise on requirements so that foams can be tested before introduction of legislation															
Small Scale Testing and selected large scale testing with a range of fuels including water soluble.	LASTFIRE is about to embark on this sort of programme working with German Industrial Firefighters et al.															
Large scale testing of proven foam concentrates and monitor application to deep seated (deep fuel) fires	Planning this with GESIP and others															
Approvals Listings	Critical in some areas globally and in some industries															

ANNEX XV RESTRICTION REPORT – PFAS IN FIREFIGHTING FOAMS

Task	Notes	t-4	t-3	t-2	t-1	T	t+1	t+2	t+3	t+4	t+5	t+6	t+7	t+8	t+9	t+10
Modification of standards and system design/acceptance criteria	LASTFIRE working with NFPA and EN EN strictly already in place as EN 13565 refers back to EN 1568 performance criteria NFPA requires further work															
Stop using PFAS foams in training																
No more PFAS foams used in training																
Stop using PFAS foams in system testing or, if PFASs is still in place ensure total containment and appropriate treatment	Every effort should be made to minimise the need for discharging PFAS based foams in system testing, even when full containment is available															
No more PFAS foams used in system testing																
Review and revision of site ERPs including containment issues	Suggest this should be a requirement early on in transition to minimise current usage															
Replacement of stocks with FF																
Development of company/site long term plan for transition	We suggest this should be a regulatory requirement on a site specific basis															

ANNEX XV RESTRICTION REPORT – PFAS IN FIREFIGHTING FOAMS

Task	Notes	t-4	t-3	t-2	t-1	T	t+1	t+2	t+3	t+4	t+5	t+6	t+7	t+8	t+9	t+10
Development of site programme/instructions to control stocks and use of PFAS foams, risk assessments, control/mitigation measures, containment and collection, disposal etc.																
Completion of Site Specific Transition Plans	Should include milestones and reporting															
Development and acceptance of alternative technology options using Fluorine Free Foam with appropriate testing	LASTFIRE ongoing programmes with CAF, Sef Expanding Foam, Hybrid Medium Expansion, etc.															
Development of guidance on proven and accepted methods of cleaning foam tanks and equipment																
Development of guidance on appropriate disposal routes																
Management of change evaluation and programme to ensure compatibility and effectiveness of every foam system	Companies are already beginning to evaluate this recognising the current situation															
Transition to Fluorine Free for first strike application to small incidents																
No more PFAS foams used for small incidents																

ANNEX XV RESTRICTION REPORT – PFAS IN FIREFIGHTING FOAMS

Task	Notes	t-4	t-3	t-2	t-1	T	t+1	t+2	t+3	t+4	t+5	t+6	t+7	t+8	t+9	t+10
Full corrosion and materials compatibility data of new concentrates	See LASTFIRE Typical procurement specification															
Testing of compatibility of applying different foams to an incident simultaneously																
Compatibility of concentrates data	Not good practice to mix concentrates anyway, but perhaps useful for commercial reasons															
Agreement of accepted disposal routes																
Fire testing with site specific fuels and equipment																
Roll out of site management of change programme/instructions																
Disposal of existing concentrates																
Possible development and management of interim strategic stock holdings	Although no formal plans, an option to still have current foams available if there are concerns might be for industry to develop strategic, well managed and controlled stock for major incidents. This would have to include plans for containment and immediate clean up if the stock was to be used.															

ANNEX XV RESTRICTION REPORT – PFAS IN FIREFIGHTING FOAMS

Task	Notes	t-4	t-3	t-2	t-1	T	t+1	t+2	t+3	t+4	t+5	t+6	t+7	t+8	t+9	t+10
Completion of Transition																

Appendix 5. List of international standards for firefighting foam performance (from Wood et al. 2020)

International Fire-fighting Foam Standards	Underwriters Laboratory	International Civil Aviation Organization			EN 1568			
	UL162	ICAO Level A	ICAO Level B	ICAO Level C	Part 1	Part 2	Part 3	Part 4
Description	UL 162 is an Internationally recognised test method carried out by the UL (Underwriters Laboratory), an independent not-for-profit organisation.	In the UK, the CAA (Civil Aviation Authority) requires a foam concentrate for use in Civilian Airports to be tested using potable (fresh) water to ICAO Level A, B or C.			European Standard that critically tests a foam for both extinguishment and burnback in sea and potable (fresh) water			
Sector(s) applicable	Offshore platforms	Onshore Civilian Airports	Onshore Civilian Airports	Onshore Civilian Airports	All	All	All	All
Type(s) of fire / fuel	Heptane fire, or polar solvent	Heptane fire	Heptane fire	Heptane fire	Heptane fire	Heptane fire	Heptane fire	Acetone fire
Type(s) of foam	All	All	All	All	Medium expansion foam for use on water-immiscible liquids	High expansion foam for use on water-immiscible liquids	Low expansion foam for use on water-immiscible liquids	Low expansion foam for use on water-miscible liquids
Area applicable	50 sq. feet	2.8m ²	4.5m ²	7.32m ²	4.52 m ²	4.52 m ²	4.52 m ²	1.72 m ²

ANNEX XV RESTRICTION REPORT – PFAS IN FIREFIGHTING FOAMS

International Fire-fighting Foam Standards	Underwriters Laboratory	International Civil Aviation Organization			EN 1568			
	UL162	ICAO Level A	ICAO Level B	ICAO Level C	Part 1	Part 2	Part 3	Part 4
Application conditions	Using a freeze protected foam with potable (fresh) and sea water	Foam concentrate for use in Civilian Airports to be tested using potable (fresh) water	Foam concentrate for use in Civilian Airports to be tested using potable (fresh) water	Foam concentrate for use in Civilian Airports to be tested using potable (fresh) water				
Application Rate (L/min/m²)	1.63	4.1	2.5	1.75	2.52L/min/m ²	2.52L/min/m ²	2.52L/min/m ²	6.6L/min/m ²
Discharge Rate (L/min) and duration	18.6 (180 s)	11.4 (120 seconds)	11.4 (120 seconds)	11.4 (120 seconds)				
Extinguishing time (with flickers)		<60 seconds	<60 seconds	<60 seconds				
Extinguishing time (full)	<180 seconds	<120 seconds	<120 seconds	<120 seconds				
Pre-burn time	60 seconds	60 seconds	60 seconds	60 seconds	60 seconds	60 seconds	60 seconds	120 seconds

ANNEX XV RESTRICTION REPORT – PFAS IN FIREFIGHTING FOAMS

International Fire-fighting Foam Standards	Underwriters Laboratory	International Civil Aviation Organization			EN 1568			
	UL162	ICAO Level A	ICAO Level B	ICAO Level C	Part 1	Part 2	Part 3	Part 4
Burnback test (and waiting time)	Yes (20% in 300 seconds); 540 seconds	Yes, 2 minutes	Yes, 2 minutes	Yes, 2 minutes				
20% Re-ignition Time (mins)		>5	>5	>5				
Nozzle type	Hose nozzles, monitors	"Uni 86" Foam Nozzle"	"Uni 86" Foam Nozzle"	"Uni 86" Foam Nozzle"	"Uni 86" Foam Nozzle"	"Uni 86" Foam Nozzle"	"Uni 86" Foam Nozzle"	"Uni 86" Foam Nozzle"
Nozzle pressure (Kpa)	Not specified	700	700	700				
Degradation considered	No	No	No	No				
Pass/Fail test?	Yes	No	No	No	Not a pass or fail standard	Not a pass or fail standard	Concentrates are allocated grades of performance, ie Grade 1-4 for extinguishing performance and Grades A-D for	Concentrates are allocated grades of performance, ie Grade 1-2 for extinguishing performance and Grades A-C for

ANNEX XV RESTRICTION REPORT – PFAS IN FIREFIGHTING FOAMS

International Fire-fighting Foam Standards	Underwriters Laboratory	International Civil Aviation Organization			EN 1568			
	UL162	ICAO Level A	ICAO Level B	ICAO Level C	Part 1	Part 2	Part 3	Part 4
							burnback resistance. 1A is the highest achievable grade	burnback resistance. 1A is the highest achievable grade
Frequency of monitoring/ conformity testing	3 months	N/A	N/A	N/A				
Sea water or powder compatibility	Sea water	No test protocol provided	No test protocol provided	No test protocol provided				

ANNEX XV RESTRICTION REPORT – PFAS IN FIREFIGHTING FOAMS

	International Maritime Organization		CAP 437	Defense Specification (US)	National Fire Protection Agency (NFPA)	ISO - 7203			
	IMO MSC.1/Circ.1312	IMO MSC Circ.670	CAP 437	MIL-F-24385	NFPA 11	7203-1	7203-2	7203-3	7203-4
Description	These standards ensure that foam used at sea is fit for purpose and takes into consideration performance with sea water induction and temperature conditioning (accelerated ageing).		For UK offshore helidecks, the standard adopted by the Civil Aviation Authority (CAA) is CAP 437 – Standards for Offshore Helicopter Landing Areas, Chapter 5, paragraph 2.6.	MIL-F-24385 is a US Defence Test Specification that critically tests AFFFs for both extinguishment and burnback in sea and potable (fresh) water.	NFPA 11 is an internationally recognised US Standard for Low-, Medium-, and High-Expansion Fire Fighting Foam.				
Sector(s) applicable	Maritime	Maritime	Offshore Helidecks (UK)	Defence					
Type(s) of fire / fuel				Heptane fire, Unleaded petrol					
Type(s) of foam									
Area applicable									
Application conditions			Tested in sea water and freeze protected	Using foam with potable and sea water.					
Application Rate (L/min/m2)	2.52	2.52		1.65 or 2.91					

ANNEX XV RESTRICTION REPORT – PFAS IN FIREFIGHTING FOAMS

	International Maritime Organization		CAP 437	Defense Specification (US)	National Fire Protection Agency (NFPA)	ISO - 7203			
	IMO MSC.1/Circ.1312	IMO MSC Circ.670	CAP 437	MIL-F-24385	NFPA 11	7203-1	7203-2	7203-3	7203-4
Discharge Rate (L/min) and duration	11.4 (300 sec +/- 2)	11.4 (300 sec +/- 2)		7.57 (90 seconds)					
Extinguishing time (with flickers)									
Extinguishing time (full)	Depends on class	Depends on class		Depends on pan; <30; <50					
Pre-burn time				10 seconds					
Burnback test (and waiting time)				Yes (25% in 360 seconds); 60s					
20% Re-ignition Time (mins)									
Nozzle type	"Uni 86" Foam Nozzle"	"Uni 86" Foam Nozzle"				"Uni 86" Foam Nozzle"	"Uni 86" Foam Nozzle"	"Uni 86" Foam Nozzle"	"Uni 86" Foam Nozzle"
Nozzle pressure (Kpa)	630 +/- 30	630 +/- 30		680					
Degradation considered				Yes- requires a result of 50% or greater for a BOD/ COD ratio					

ANNEX XV RESTRICTION REPORT – PFAS IN FIREFIGHTING FOAMS

	International Maritime Organization		CAP 437	Defense Specification (US)	National Fire Protection Agency (NFPA)	ISO - 7203			
	IMO MSC.1/Circ.1312	IMO MSC Circ.670	CAP 437	MIL-F-24385	NFPA 11	7203-1	7203-2	7203-3	7203-4
Pass/Fail test?									
Frequency of monitoring/ conformity testing									
Sea water or powder compatibility	Sea water (if compatible)	Sea water (if compatible)		Sea water, powder					

Appendix 6. List of alternative firefighting foam products available on the EU market, as identified by Wood et al. 2020 in the consultation responses

Product	Manufacturer/Supplier
ECOPOL	Bio-ex
BIO FOR	Bio-ex
BIO FOAM	Bio-ex
BIO T3	Bio-ex
BIO T6	Bio-ex
RE-HEALING™ RF3, 3% Low Viscosity Foam Concentrate	Solberg
PROFOAM 806G	Gepro Group
Sthamex F-15	Dr. Sthamer
Sthamex F-6	Dr. Sthamer
Testschaum V	Dr. Sthamer
Freedol SF	3F
Freedol	3F
Freefor SF	3F
Hyfex SF	3F
Freedex SF	3F
Respondol ATF 3-3	Angus fire
Respondol ATF 3-6	Angus fire
High Combat A	Angus Fire
Jetfoam 1%	Angus fire
Jetfoam 3%	Angus fire
Jetfoam 6%	Angus fire
Syndura	Angus fire
Expandol LT	Angus fire
Expandol	Angus fire
Forexpan	Angus fire
Trainol-3	Angus fire

ANNEX XV RESTRICTION REPORT – PFAS IN FIREFIGHTING FOAMS

Product	Manufacturer/Supplier
Trainol-6	Angus fire
TF 3	Angus fire
TF 6	Angus fire
TF 90	Angus fire
Unipol FF 3/6	Auxquimia
TF 136	Auxquimia
EE-3	Auxquimia
SF-60 L	Auxquimia
H-930	Auxquimia
RFC-105	Auxquimia
CAFOAM	Auxquimia
Unipol FF 1	Auxquimia
Class A Plus	Chemguard
Extreme	Chemguard
DeltaFire	DeltaFire
Schaumgeist	Dr. Sthamer
Sthamex F-6	Dr. Sthamer
Sthamex F-15	Dr. Sthamer
Sthamex F-20	Dr. Sthamer
Sthamex F-25	Dr. Sthamer
Sthamex-class A	Dr. Sthamer
Moussol FF 3x6	Dr. Sthamer
Fettex	Dr. Sthamer
Übungsschaummittel-N	Dr. Sthamer
Übungsschaummittel-U	Dr. Sthamer
Sthamex - K	Dr. Sthamer
iFoam	Febbex
Greenagent Technology	Fireade
-	Firechem
-	Foamtech AntiFire

ANNEX XV RESTRICTION REPORT – PFAS IN FIREFIGHTING FOAMS

Product	Manufacturer/Supplier
Enviro 3x3 Plus	Fomtec
Enviro 3x3 ultra	Fomtec
Enviro 3 % ICAO	Fomtec
Enviro 3x6 Plus	Fomtec
Enviro 6x6 Plus	Fomtec
Enviro USP	Fomtec
KV-Lite PF	KVFires
KV-Lite HEF	KVFires
KV-Lite HAZMAT Foam	KVFires
KV-Lite Class-K Foam	KVFires
Ecopol	Leader/ BioEx
Ecopol 3x6	Leader/ BioEx
Ecopol 6	Leader/ BioEx
Ecopol F3HC	Leader/ BioEx
Bio T3	Leader/ BioEx
Bio T6	Leader/ BioEx
Bio for C	Leader/ BioEx
Bio for N	Leader/ BioEx
Bio for S	Leader/ BioEx
Bio Foam 5	Leader/ BioEx
Bio Foam 15	Leader/ BioEx
Responder Class A	NationalFoam
Knockdown	NationalFoam
High Expander	NationalFoam
Training Foam	NationalFoam
Bluefoam 3x3	Orchidee
Bluefoam 1x3	Orchidee
Bluefoam 3x6	Orchidee
Bluefoam 6x6	Orchidee
Orchidex ME 1% F-ECO	Orchidee

ANNEX XV RESTRICTION REPORT – PFAS IN FIREFIGHTING FOAMS

Product	Manufacturer/Supplier
Orchidex ME 3% F-ECO	Orchidee
Orchidex ME 3% HP	Orchidee
Orchidex ME 3% F-10	Orchidee
Orchidex ME 3% ECO	Orchidee
Orchidex ME 6% F-ECO	Orchidee
Orchidex Training Foam	Orchidee
Orchidex A	Orchidee
Orchidee XF 3000	Orchidee
Re-Healing Foam RF-H+	Solberg
Re-Healing Foam RF1 1%	Solberg
Re-Healing Foam RF1-S 1%	Solberg
Re-Healing Foam RF3 3%	Solberg
Re-Healing Foam RF6 6% 1	Solberg
Re-Healing Foam RF3x3 FP ATC	Solberg
Re-Healing Foam RF3x6 ATC	Solberg
Re-Healing Foam RF 3x6 FP ATC	Solberg
Re-Healing Foam RF-MB	Solberg
Re-Healing Foam RF6 6% 2	Solberg
Re-Healing TF	Solberg
Aberdeen Foam 1% F3	OilTechnics
Aberdeen Foam 3% F3	OilTechnics
Aberdeen Foam 3x3% AR-F3	OilTechnics
Aberdeen Foam 1% Class A	OilTechnics
Aberdeen Foam 1% Training Foam	OilTechnics
Aberdeen Foam 3% Training Foam	OilTechnics
Silvara 1	vsFocum
Silvara ZFK	vsFocum
Silvara APC 3x3%	vsFocum

ANNEX XV RESTRICTION REPORT – PFAS IN FIREFIGHTING FOAMS

Product	Manufacturer/Supplier
Silvara APC 3x6%	vsFocum

Appendix 7. RO 4: description of the derogation mechanism as suggested by Eurofeu

RO 4 is restriction on the placing on the market and use of PFAS-based firefighting foams with different transitional periods per type of use and the provision for a derogation mechanism via the local environmental permit system to which Seveso establishments and defence sites would be eligible. Eurofeu provided (Eurofeu, 2021) a description of the process they suggested to be applied to Seveso establishments and its advantages which is reproduced below.

7.1. Description of the process to grant a permit for use of fluorine containing firefighting foam agents

- 1) Only industrial sites imposing a specifically high risk are eligible to apply for a timed special permit to use fluorine containing foam agents for their fire protection measures.
- 2) The required precondition to prove the specifically high risk is the site's official status as SEVESO sites according to the EU's SEVESO regulation.
- 3) The special permit would be subject to annual renewal.
- 4) The first application requires to provide certain information:
 - a. The applicant must provide a solid justification for the need to continue using fluorine containing foam agents
 - b. The applicant must provide a clear transition plan with measurable milestones
 - c. The applicant must have measures in place to collect all emissions
- 5) Every following revision would require a comprehensive report of the applicant containing:
 - a. A full balance sheet of all volume streams of the firefighting foam agent on site (sourced – used – disposed)
 - b. A full report on transition efforts and -status relative to the approved plan and current state of the art
 - c. A review of the initial approved justification against the transition plan and latest technology achievements.
- 6) In its revision the authority in charge of operation permits would review the report, match it against recent state of the art of fire protection (e.g. by comparing with other companies having similar risks) and the projected and agreed targets.
 - a. If acceptable the permit will be renewed for 12 months
 - b. If not acceptable the permit to use fluorine containing foam will be withdrawn and a deadline for the phase out of the foam agent will be set.
 - c. The overall operation permit of the site would then be on stake.

7.2. Benefits

- **Site operators** have an instrument at hand to adjust the pace of their transition away from fluorine containing foam agents to their technical and economic power. This reduces the risk of unwanted shutdowns of sites or loss of companies.

ANNEX XV RESTRICTION REPORT – PFAS IN FIREFIGHTING FOAMS

- The option to apply for a special permit would not be limited to a certain dimension of a tank but encompass the risk scenario. This opens a window for sites which may not have large enough tanks to benefit from the proposed derogations but still need to manage very high fire- and escalation risks.
- **Authorities** would gain solid and exact data on the stocked, consumed, used and disposed volumes of fluorine containing foams
- **Authorities** would get comprehensive and accurate data of the level of releases to the environment and could use those to adjust the pace of transition
- **Authorities** are in full control of the process and can adjust the pace of the industry's overall transition to the pace of availability of acceptable alternatives
- Since a process for granting an operation permit to industrial sites is established in all EU member states and, since that operation permit already covers fire safety measures no new process needs to be developed and established. Same is valid for the processes for surveillance and review of the operation permits.

It would however be necessary to develop the criteria for the permit and its renewal.

- **Authorities** can adjust the pace of the industry's overall transition to the pace of availability of acceptable alternatives
- **Manufacturers** of fluorochemicals and of firefighting foam agents would only manufacture based upon a given permit. This resolves the issue of liabilities resulting from uncontrollable preconditions
- **Authorities** could track volumes being placed on the market and match against the permitted volumes

Appendix 8. Details of the calculations used in the emissions model and results obtained

This appendix describes in more details the calculations and equations used in the emission model for the baseline scenario and the five ROs and the results obtained from the model.

8.1. Calculation descriptions

8.1.1. Simulation of the baseline scenario

The baseline scenario is a scenario in the absence of restrictions (= current situation). Similar to the methodology in Wood et al. (2020), four life cycle stages were identified in which emissions occur or material (PFASs) passes to the next life cycle stage: 1) formulation of the firefighting foam concentrate, 2) storage (stock), 3) in-use (training, live incidents) and 4) waste treatment (incineration, WWT), see Figure 23. It is assumed that the mass balance input for each life cycle stage is equal to the output. Furthermore, a constant quantity of PFAS firefighting foam in stock as been assumed.

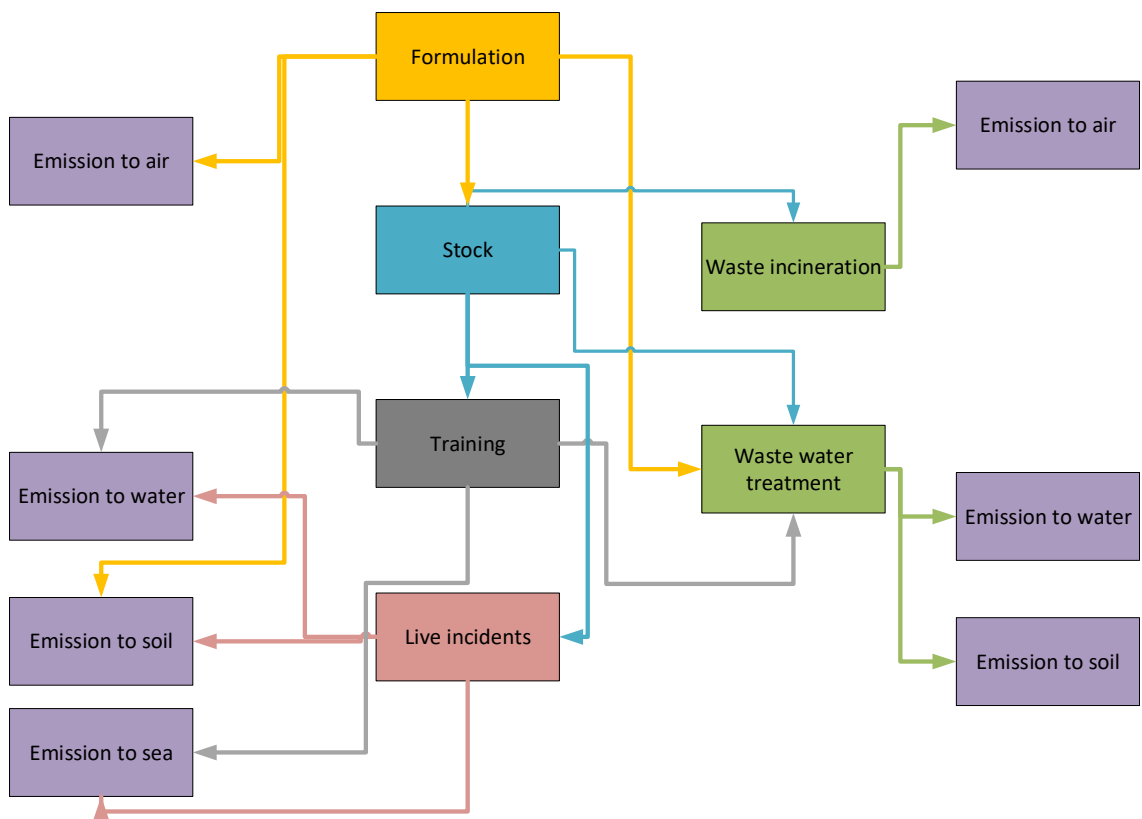

Figure 23. Material flow diagram showing the connection between the different life cycles stages formulation, in-use, stock and waste treatment for PFASs in firefighting foams in the baseline scenario.

The market share of live incidents or training is calculated as the product of the market share per sector and the percentage used in live incidents or training (see values in section 3 “Assumptions, uncertainties and sensitivities” of the main report).

Equation 1

$$market\ share_{incidents\ sector} = market\ share\ sector \times \% \text{ live incidents}$$

The total amount PFAS foam per sector is equal to the product of the annual sale of PFAS containing foam (see values in section 3 “Assumptions, uncertainties and sensitivities” of the main report) and the market share per sector (Equation 2).

Equation 2

$$amount\ sector = market\ share_{incidents\ sector} \times annual\ sale$$

The annual use per sector is the product of the total amount per sector (Equation 3) and the annual use rate (Equation 4).

Equation 3

$$annual\ use\ sector = amount_{sector} \times annual\ use\ rate\ sector$$

Equation 4²⁶

$$annual\ use\ rate\ sector = \frac{amount_{sector} - stock\ leak_{sector} - \del{expired\ stock}}{amount_{sector}}$$

8.1.2. Formulation of the firefighting foam concentrate

For the simulation of PFAS emissions, it is assumed that the sales and the amount of PFAS foam in the formulation are identical. During the formulation, direct emissions of PFASs occur to the environmental compartments soil and air, and an indirect emission occurs via WWT (Figure 24).

²⁶ For information on the “~~expired stock~~” in this formula, see 8.1.3 Stock

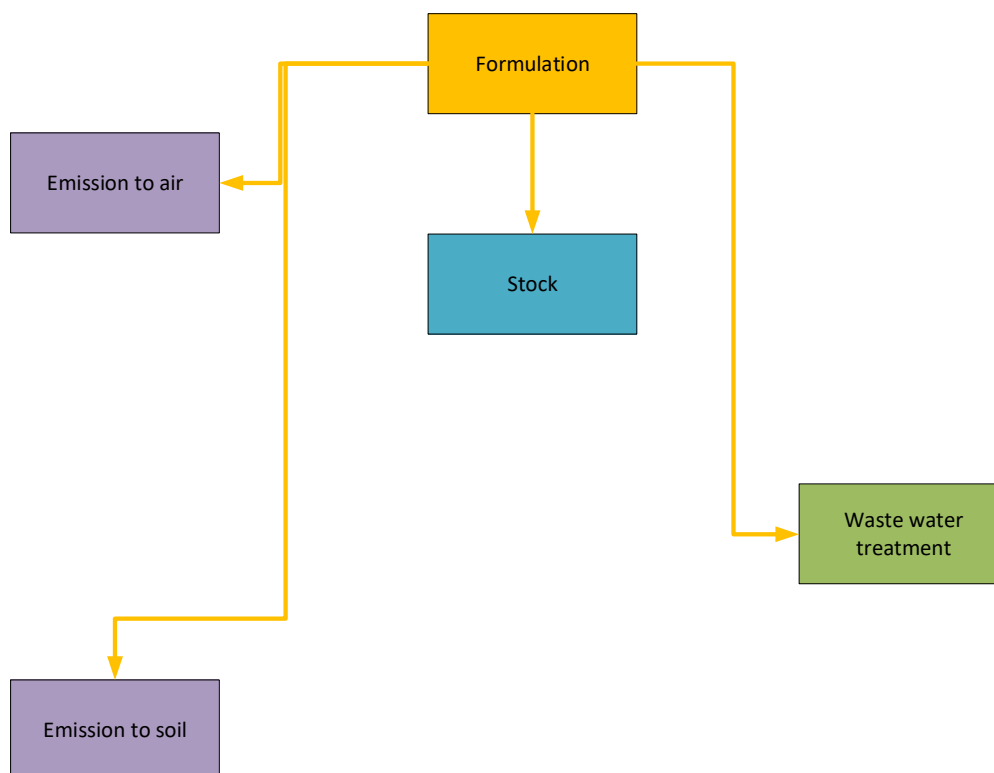

Figure 24. Material flow diagram for the formulation phase

The yearly amount of PFAS firefighting foam formulated is calculated as:

Equation 5

$$formulation_{sector} = annual\ sales \times market\ share_{sector}$$

Emissions to soil, air and wastewater treatment are calculated by multiplying the quantity of formulated PFAS firefighting foam by their respective emission factors (see values in section 3 “Assumptions, uncertainties and sensitivities” of the main report):

Equation 6

$$emission\ soil_{formulation} = formulation_{sector} \times EF_{formulation-soil}$$

EF = emission factor

Equation 7

$$emission\ air_{formulation} = formulation_{sector} \times EF_{formulation-air}$$

Equation 8

$$WWT_{formulation} = formulation_{sector} \times EF_{formulation-WWT}$$

8.1.3. Stock

Figure 25 shows the material flow diagram for the life cycle stage stock: after formulation, PFAS firefighting foams are collected in the stock; the quantity in stock serves as a supply for the use of PFAS firefighting foams during incidents and training. Losses occur through incineration of expired PFAS firefighting foams on the one hand, and through leakage from the stock to wastewater treatment (WWT) on the other.

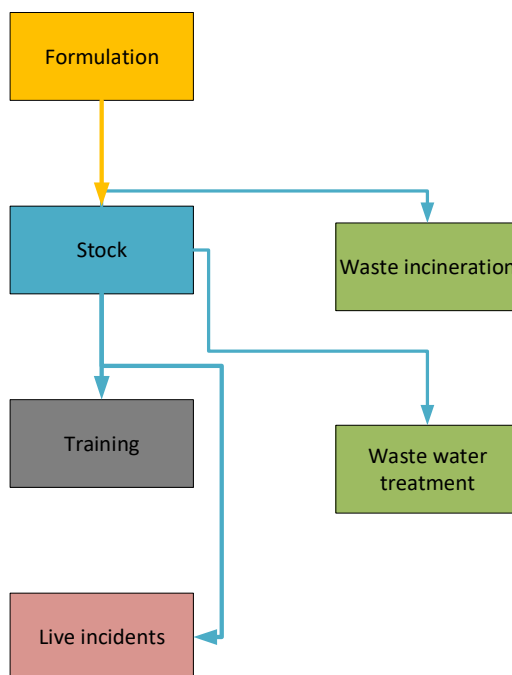

Figure 25. Material flow diagram for the for the life cycle stage Stock

The PFAS firefighting foam stock in year 0 should be derived so that the annual sale indicated in the table in section 3 “Assumptions, uncertainties and sensitivities” of the main report is obtained. This is done by simulating the stock in function of the annual sale, the annual stock use rate and the amount of PFASs that leaks out of the stock during storage (all given in the table in section 3 “Assumptions, uncertainties and sensitivities” of the main report):

Equation 9

$$stock = \left(\frac{an. sale}{(an. stock use rate incidents + training)} \right) - \left(\frac{an. sale}{(an. stock use rate incidents + training)} \right) \times stock leak\%$$

E.g., an annual sale of 18 000 t foam, stock use rates of 10% and 2% for incidents and training/testing respectively and a leakage of PFAS during storage of 1% of the quantity in stock results in a stock of 148 500 t firefighting foam. Since the stock is calculated from the annual sales and the % of the stock that is used annually, the stock calculated in this way will be higher when a smaller share of the stock is used, as exemplarily shown in Table 3:

Table 3. Interdependence between annual usage rate and corresponding stock assumed

Annual sale = tonnes of foam used per year inclusive stock losses	18 000	18 000
Annual usage rate stock incidents	0.10	0.05
Annual usage rate stock training and testing	0.02	0.02
Stock (tonnes foam)	148 500 (12 %*stock ~18 000)	254 571 (7%*stock ~18 000)

A larger stock results in more emissions from the stock (through leakage, and possibly incineration of expired stock). These emissions remain the same during the entire sector specific transition periods, which means that the emissions are higher at lower use percentages.

The mass balance of year 0 of the amount of foam “flowing out” of the stock (i.e. amounts used for training/testing + used for incidents + disposed of + leaked during storage) shall be equal to the annual sale (“flowing in” the stock).

Part of the stock will expire each year and will be incinerated and emitted into the air; the amount of expired stock is calculated as the amount in stock minus the amount of used stock divided by the average life span. The annual use (Equation 3) is equal to the difference between the annual sales and the losses from stock (losses from storage and disposed of). The amount of disposed stock (expired → waste incineration) is calculated from the annual use and the original stock (= stock in year 0):

Equation 10

$$\text{expired stock} = \frac{\text{stock} - (\text{annual use} \times \text{average life span foam})}{\text{average life span foam}}$$

Due to a circular reference in Excel, it is not possible to take the disposed (expired) quantity of stock into account when calculating the annual use (Equation 3 and Equation 4). The effect of this simplification is small, for an annual use of e.g. 20 000 tons of foam the difference is less than 85 tons of foam.

Stock emissions to wastewater treatment are estimated by applying the “leakage during storage factor” (see table in section 3 “Assumptions, uncertainties and sensitivities” of the main report) on the estimated amount of PFAS foam in stock (Equation 11).

Equation 11

$$WWT_{\text{stock leak}} = \% \text{ leak during storage} \times \text{stock}_{\text{without leak}}$$

WWT = waste water treatment

Equation 12

$$\text{stock}_{\text{without leak}} = \left(\frac{\text{an. sale}}{(\text{an. stock use rate incidents} + \text{training})} \right)$$

In the Excel spreadsheet, the stock of PFAS firefighting foams is divided over the different types of uses/sector.

8.1.4. Use phase – incidents and training

Part of the PFAS foam in stock is used during incidents and training activities. Under the baseline scenario, emissions from incidents enter the environment directly via surface water, soil and sea. Emissions from training and testing enter the environment via surface water, sea and indirectly via WWT (Figure 26).

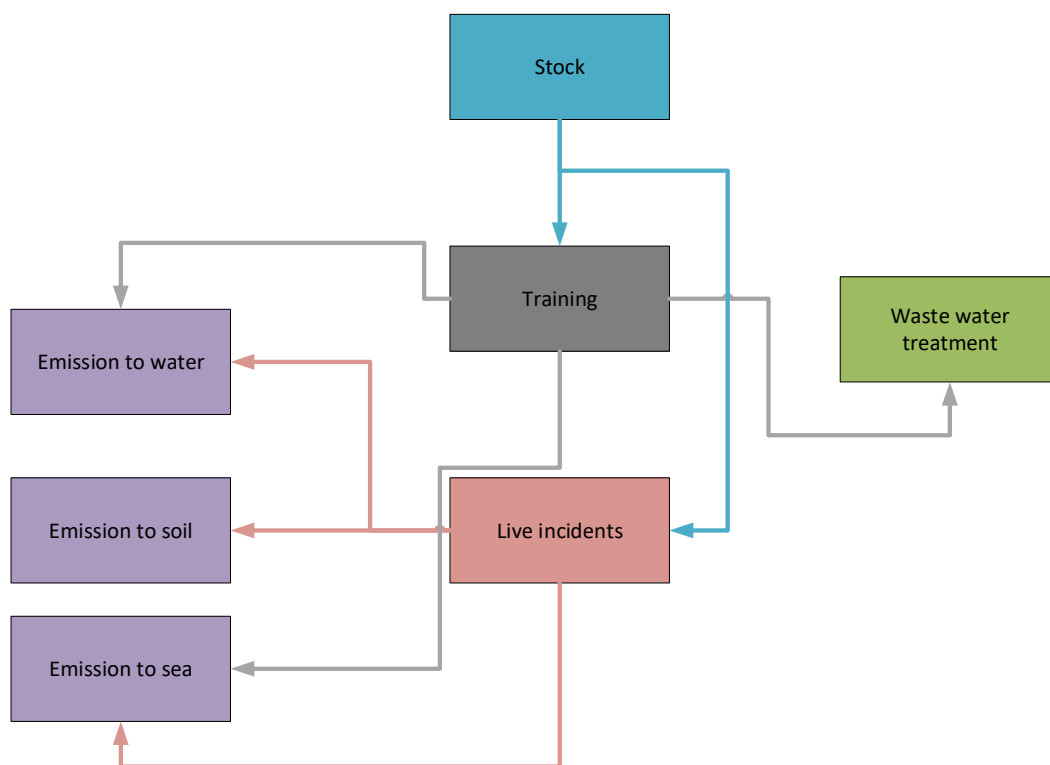

Figure 26. Material flow diagram for the life cycle stages training and incidents under the baseline scenario.

The amount of PFAS containing firefighting foam used for training and incidents is calculated in Equation 3. The emissions from incidents to soil, water and sea are calculated by multiplying the quantity of used PFAS firefighting foam by their respective emission factors (see table in section 3 “Assumptions, uncertainties and sensitivities” of the main report).

Equation 13

$$emission\ soil_{incidents} = annual\ use_{sector} \times EF_{incidents-soil}$$

Equation 14

$$emission\ surface\ water_{incidents} = annual\ use_{sector} \times EF_{incidents-surface\ water}$$

Equation 15

$$emission\ sea_{incidents-marine} = annual\ use_{incidents-marine} \times EF_{incidents-sea}$$

It is assumed that for the training and testing life cycle stage most of the PFAS firefighting foam will be captured and end up in WWT (see table in section 3 “Assumptions,

uncertainties and sensitivities” of the main report); moreover it is assumed that direct emissions occur to surface water and to the sea, but not to soil or air²⁷.

The amount of foam and PFAS-containing fire run-off water captured (bundling) during training and testing activities is estimated by applying the sector specific efficacy factor of bundling/control measures to the amount of PFAS firefighting foam used for training and testing purposes. Under the baseline scenario, based on the limited information received from stakeholders, the amount of foam and PFAS-containing fire run-off water collected in this way is assumed to be fully further directed to the wastewater treatment plant. Some foam users indicated that their collected fire run-off water is handled by licenced waste operators, however, the nature of the treatment of this waste is unclear. In addition, even though these practices might be required by some local authorities, it is assumed not to be the standard approach across the EEA for all sectors of use. For these reasons, the emissions model assume as a worst-case that under the baseline scenario all collected PFAS fire run-offs are directed to WWTPs. As regards to the emissions calculations under the five ROs, risk management measures and efficiency factors for those have been taken into account (see below the description for the different ROs and the table in section 3 “Assumptions, uncertainties and sensitivities” of the main report for information on the input parameters taken).

Equation 16

$$WWT_{training} = annual\ use_{sector} \times efficacy\ bundling\ training$$

Equation 17

$$emission\ surface\ water_{training} = annual\ use_{sector} \times (100\% - efficacy\ bundling\ training)$$

Equation 18

$$emission\ sea_{training-marine} = annual\ use_{training-marine} \times (100\% - efficacy\ bundling\ training)^{28}$$

8.1.5. Waste treatment

Under the baseline scenario the supply of PFAS foams to WWTP occurs via formulation, leakage from stock and training and testing activities. Subsequently, the PFASs end up in sludge (soil) and effluent (surface water). Expired PFAS firefighting foams are incinerated, which leads to PFASs being emitted into the air.

²⁷ this is in analogy with the Excel tool prepared by Wood to calculate emissions

²⁸ Efficacy of bundling for marine applications is 0%

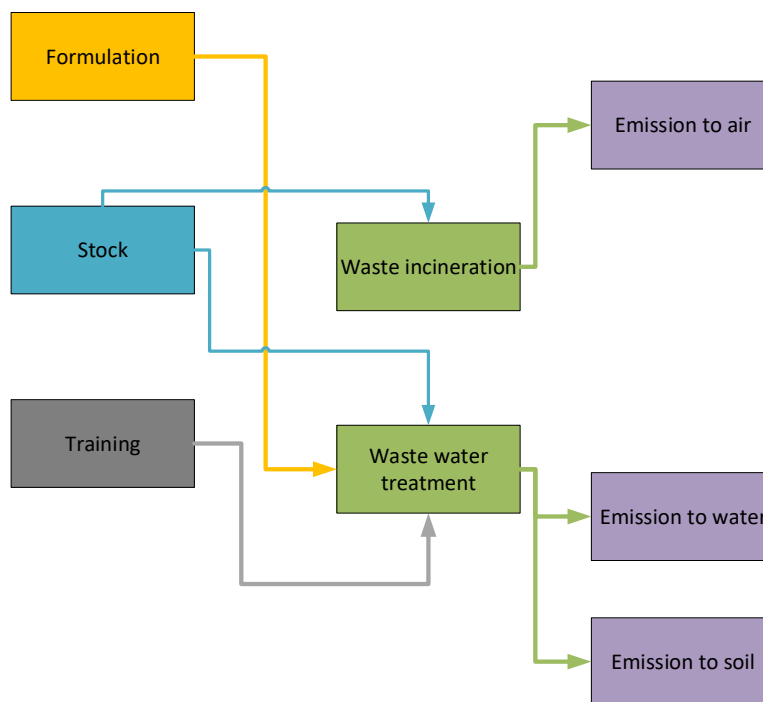

Figure 27. Material flow diagram for the waste treatment phase under the baseline scenario.

The amount of PFAS containing firefighting foam in the wastewater treatment is the sum of foam captured during training and testing, leaks and spills from the stock and losses during the formulation phase.

Equation 19

$$WWT = WWT_{training} + WWT_{formulation} + WWT_{stock\ leak}$$

The efficacy of the wastewater treatment is set to zero and all the PFASs end either in surface water or in sludge used on land. The share of PFASs in surface water/sludge depends on the Koc of the substances considered as given in table in section 3 “Assumptions, uncertainties and sensitivities” of the main report.

Equation 20

$$emission\ soil_{WWT} = (WWT \times share\ to\ soil) \times (100\% - efficacy\ WWT)$$

Equation 21

$$emission\ surface\ water_{WWT} = (WWT \times share\ to\ surface\ water) \times (100\% - efficacy\ WWT)$$

Emission to air is caused by the incineration of expired stock, which is calculated in Equation 10:

Equation 22

$$emission\ air_{WI} = expired\ stock \times EF_{incineration}$$

WI = waste incineration

8.1.6. Emissions to soil, surface water, air and sea

In a first phase, the emissions for the current baseline situation (referred to as 'year 0' in the Excel spreadsheet) are calculated using the input parameters described above (see table in section 3 "Assumptions, uncertainties and sensitivities" of the main report).

The emissions to soil, surface water, air and sea in the baseline scenario are calculated as the sum of the emissions from the life cycle stages formulation, stock, training and testing, incidents and the waste phase.

Equation 23

$$emission\ soil = emission\ soil_{WWT} + emission\ soil_{incidents} + emission\ soil_{formulation}$$

Equation 24

$$\begin{aligned} emission\ surface\ water & \\ &= emission\ surface\ water_{WWT} + emission\ surface\ water_{incidents} \\ &+ emission\ surface\ water_{training} \end{aligned}$$

Equation 25

$$emission\ air = emission\ air_{WI} + emission\ air_{formulation}$$

Equation 26

$$emission\ sea = emission\ sea_{incidents-marine} + emission\ sea_{training-marine}$$

8.2. RO1: Ban on the placing on the market, use allowed

For simulating RO1, a steady state level of use and sale was assumed **during the sector specific transition periods**, this means that the yearly emissions during the transition period equal the emissions in year 0. Furthermore, it was assumed that the stock remained the same as in year 0 during the use/sector-specific transition period.

In a period of 15 years (= average life span concentrate) after the use/sector specific transition period, PFAS foams were no longer formulated and sold for the use/sector in question, but the use continues and gradually declines (Equation 27).

Equation 27

$$annual\ use\ year\ x = annual\ use\ year\ 0 \times \left(1 - \frac{(year\ x - length\ transition\ period)}{(average\ life\ span\ foam + 1)} \right)$$

Consequently, emissions from the formulation life cycle were set to zero at the end of each use/sector-specific transitional period. The amount of PFASs in stock was calculated for each year as the amount in the original stock (year 0) minus the cumulative use since the end of the sector specific transition period, the amount expired, and the amount leaked from the stock since the end of the transition period.

Equation 28

$$stock\ year\ x = stock\ year\ 0 - cumulative\ use - (expired\ stock \times (year\ x - length\ TP)) - WWT_{stock\ leak}$$

The emissions to soil and water are calculated as the sum of the direct emissions from the linearly decreasing use for incidents and training/testing and the emissions from wastewater treatment. The latter was estimated as the sum of the material flows from training activities and leakage from the stock.

Equation 29

$$WWT = WWT_{training} + WWT_{stock\ leak}$$

It is assumed that in year 16 after the use/sector-specific transition period (foam lifespan 15 years + 1 year), no more PFAS-containing foams will be used, and the remaining stock, if any, will be incinerated.

Equation 30

$$emission\ air_{WI} = remaining\ stock \times EF_{incineration}$$

The simulations were carried for the 'Low', 'Best' and 'High' emission estimates and for a period of 30 years.

8.2.1. RMMs for training, testing and incidents

In addition to this, RMMs for training and testing were simulated. For this purpose, disposal via incineration of the firewater collected from training and testing was taken into account. In this scenario, it is assumed that the collected firefighting foams are incinerated instead of being discharged to the WWTP (see Figure 28).

The restriction proposal suggest such RMMs to be mandatory from 6 months after entry into force, however, for the simulation in Excel, since it is built per year, for simplicity these RMMs were considered as starting to take place one year after entry into force (i.e. beginning of year 2).

Equation 31

$$WI_{training} = annual\ use_{sector} \times efficacy\ bunding\ training$$

In a further step, RMMs for incidents were added to the Excel, similar to the RMMs for training and testing. A percentage of firewater is assumed to be collected from incidents (see value in table in section 3 "Assumptions, uncertainties and sensitivities" of the main report) and sent to incineration. In the calculations, the RMMs have been taken into account as starting one year after entry into force.

Equation 32

$$WI_{incidents} = annual\ use_{sector} \times efficacy\ bunding\ incidents$$

Equation 33

$$emission\ soil_{incidents} = (annual\ use_{sector} - captured\ during\ incidents) \times EF_{incidents-soil}$$

Equation 34

$$emission\ surface\ water_{incidents} = (annual\ use_{sector} - captured\ during\ incidents) \times EF_{incidents-surface\ water}$$

with

Equation 35

$$captured\ during\ incidents = annual\ use_{sector} \times efficacy\ bunding\ incidents$$

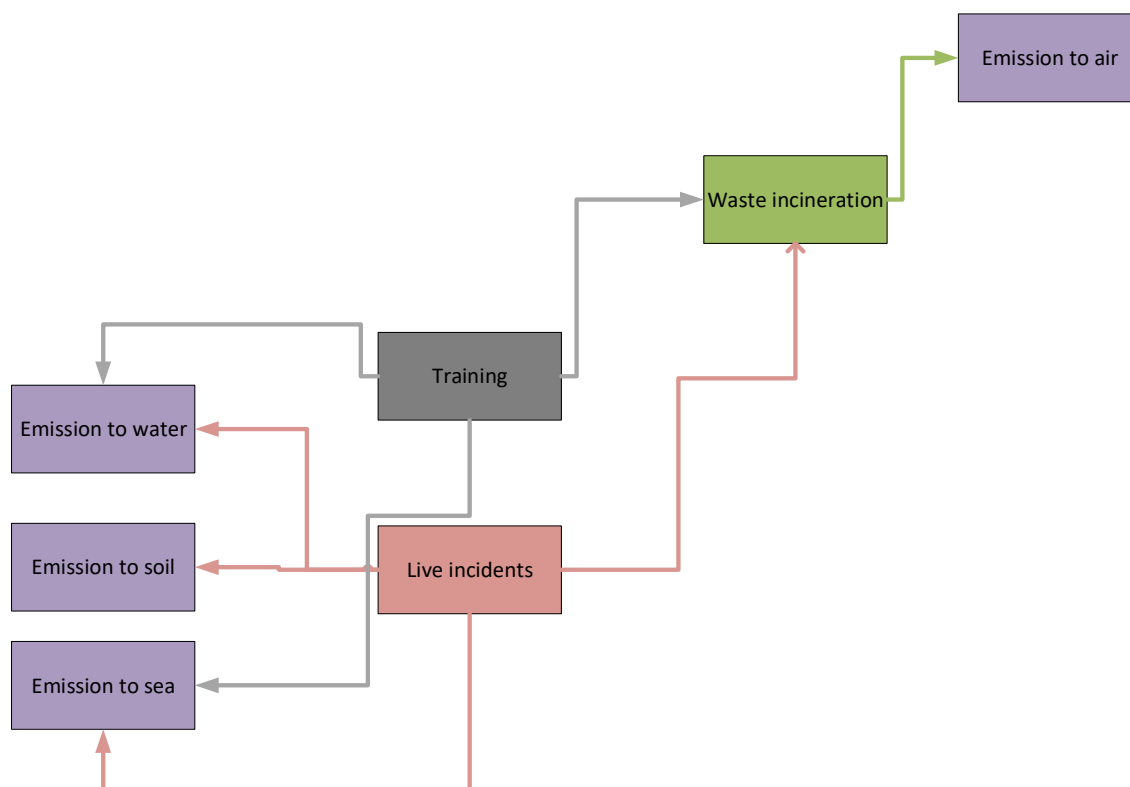

Figure 28. Material flow diagram for the life cycle stages training and incidents, including RMMs as foreseen in the ROs.

These calculations were carried out for the “Low”, “Best” and “High” emission estimates and for a period of 30 years.

8.3. RO2: Ban on the placing on the market and use

The simulations in RO2 are identical to those in RO1 with RMMs until the end of the use/sector-specific transition periods. During the transition periods, a stable level of sales and use is assumed for each sector. In the first year after the end of the transition period for a particular sector, no more PFAS-containing foams are sold or used for this sector, and the remaining stock (= stock in year 0) is considered to be incinerated. As a result, all emissions to soil, surface water and sea are set to zero. The amount of PFAS remaining in stock is multiplied with the emission factor for incineration to calculate the amount PFAS emitted to air (Equation 30). These calculations were carried out for the “Low”, “Best” and “High” emission estimates and a period of 30 years.

8.4. RO3: same as RO2 but considering emissions from the formulation for export

It has been assumed in all ROs that the amounts of PFAS firefighting foams imported in the EEA equal the amounts exported (assumed to represent 25% of annual sales). For the emissions calculations of all ROs - except RO 3 - it has been assumed that the amounts formulated for export would follow the same trend over time as the amounts sold and used in the EEA, i.e. that the exports would be progressively declining in the same way that the use in the EEA. To simulate the impact of RO 3 (which includes a ban of the export after a transitional period of ten years) on the emissions of PFASs, the share of emissions due to the formulation of foams for export has been looked at. More specifically, under RO 3, the emissions have been calculated as if the export would *continue* at the level of 25% of

annual sales (compared to the situation during the transitional periods) beyond the sector/use-specific transitional periods and until year 30.

In other words, the simulations in RO3 are identical to those in RO2, with the exception that formulation for export continues after the sector/use specific transition periods. Hence emissions are the same as in RO2 during the sector-specific transition period for use (including import = export = 25% of annual sales). However, after the transition periods, emission from formulation for export (= 25% of the yearly emission for formulation during the transition period) continues at the same level until year 30²⁹.

This emissions simulation therefore *does not* depict exactly the emissions as they would occur under an export ban (since in this simulation exports *continue* after the transitional periods) but describes more generally the share of the formulation for export on the PFAS emissions. In this way, the impact on PFAS emissions in the EEA of an export ban after 10 years is approximated. The figures of avoided emissions under RO3 as presented in the main report have been obtained by adding to the avoided emissions figure under RO2 the differential calculated by the model between RO3 and RO2 (see results for RO3 further below for details).

8.5. RO4: same as RO2 but with progressive decline of oil/chemical and defence uses

The emissions simulation for RO4 is the same as RO2, but it is assumed that, thanks to the permit system they can use, the oil/(petro)chemical (Seveso share) and defence sectors would continue using the same amounts of PFAS foams during ten years and only progressively switch to alternatives after this period (when alternatives would be considered feasible to implement), leading to a continuous linear decline in use, stock and formulation of PFAS-based foams during the next 20 years till 0. After year 27 formulation already stops as enough stock is available for use until year 30. In year 30, there is still some use and the small amount of remaining foams is considered to be incinerated. In year 31 the emission is zero.

8.6. RO5: uses banned unless releases fully contained and adequately treated

RO5 is the same as RO2, but use remains allowed after the transitional periods for uses for which a full minimisation of emissions can be ensured. For the emissions calculation under RO5 it has been assumed that only the Seveso establishments would be able to comply with the minimisation requirement after the transitional periods. The emissions calculation therefore assumes a stop of the use of all sectors after their respective transitional periods except for the oil/(petro)chemical - Seveso sector for which the level of use would continue unaffected over the assessment period. Full containment being in practice unlikely even for the Seveso establishments, emission factors have been taken into account, which results in continuous emissions of PFASs in the environment from this sector of use.

The "lighter" RMMs for training/testing and incidents are applicable for all sectors during the transition period. Under this scenario, the use by oil/(petro)chemical (Seveso share) sector has been considered to be 'endless', i.e. no substitution to alternatives, therefore, no remaining stock incineration is considered in year 30. For this sector, there is still a

²⁹ This value can easily be changed to 10 years by changing cell D2 in the excel file.

complete stock left that is not incinerated in year 30, while in the other ROs no stock is left at the end of year 30.

8.7. Emissions results

8.7.1. Baseline scenario

The calculated emissions under the baseline scenario are presented in Annex B.9.3.2

8.7.2. RO1: Ban on the placing on the market

8.7.2.1. Emission patterns

The avoided emissions for a period of 30 years resulting from RO1 are shown in table format in Annex E.5.2. Additional illustrations of the evolution of the emissions are provided below.

Figure 29 shows the cumulative emission to soil, air and surface water with and without RMM for chemical / petrochemical Seveso incidents ("Best scenario"). The figure clearly shows that cumulative emissions to soil and surface water are lower when RMMs are applied. For emissions to sea (marine applications, not shown here), there is no difference between simulations with and without RMM, since RMMs are not applicable here. Cumulative emissions to air are much lower and show a different trend than emissions to soil or surface water. The emissions to air simulated for the scenario with RMM are higher than for the scenario without RMM because in the scenario with RMM a percentage of the PFAS foam is assumed to be incinerated after use. For Seveso, emissions rise steeply during the first 10 years (transition period in the "Best" estimate scenario) and then increase more slowly when RMM is applied or even disappear completely in the scenario without RMM. This is because in the absence of RMM, emissions to air are only caused by the formulation and incineration of expired stocks. The formulation of PFAS foams stops after the transition period and in the "Best" estimate scenario there is no expired stock. When RMM are applied, after the transition period, there will still be emissions from incineration of a certain percentage of the collected foam during use.

At the end of the lifespan of the PFAS foams (15 years after the sector specific transition period) the remaining stock is incinerated, which explains why the emission curve increases slightly in year 26 for Seveso and year 17 for training (transition period 1.5 years). Although there are increased emissions to air by applying RMM, these are largely compensated by the reduced emissions to soil and water, the releases having been redirected from soil/water to air but in much smaller amounts. For Seveso, for example, an increase of about 30 t PFAS emission to air is compensated by a reduction of about 1 600 t PFAS emission to surface water and soil each.

ANNEX XV RESTRICTION REPORT – PFAS IN FIREFIGHTING FOAMS

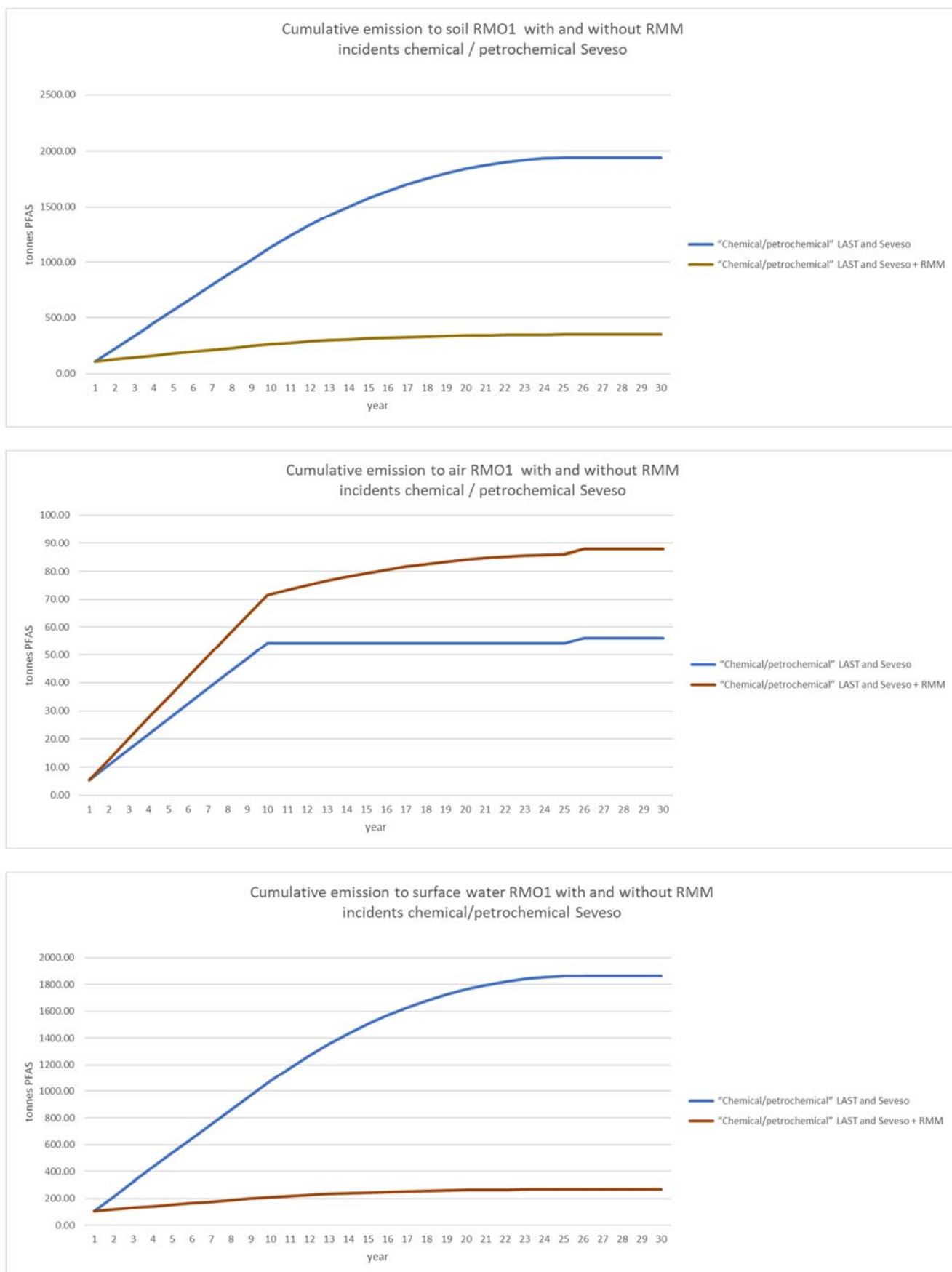
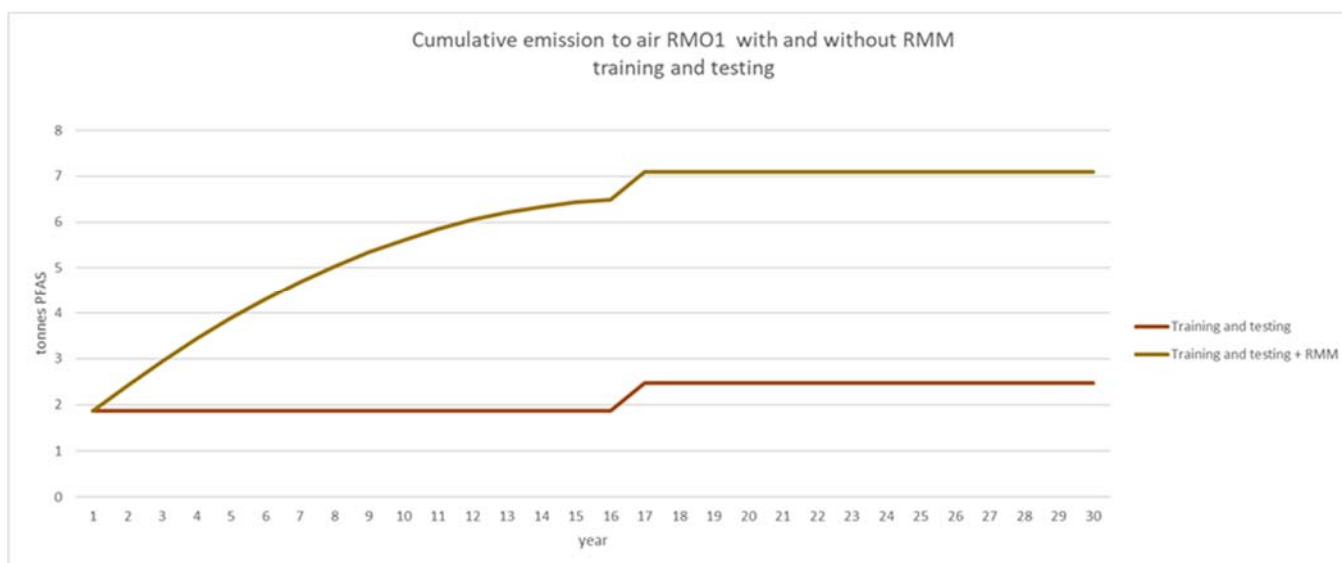
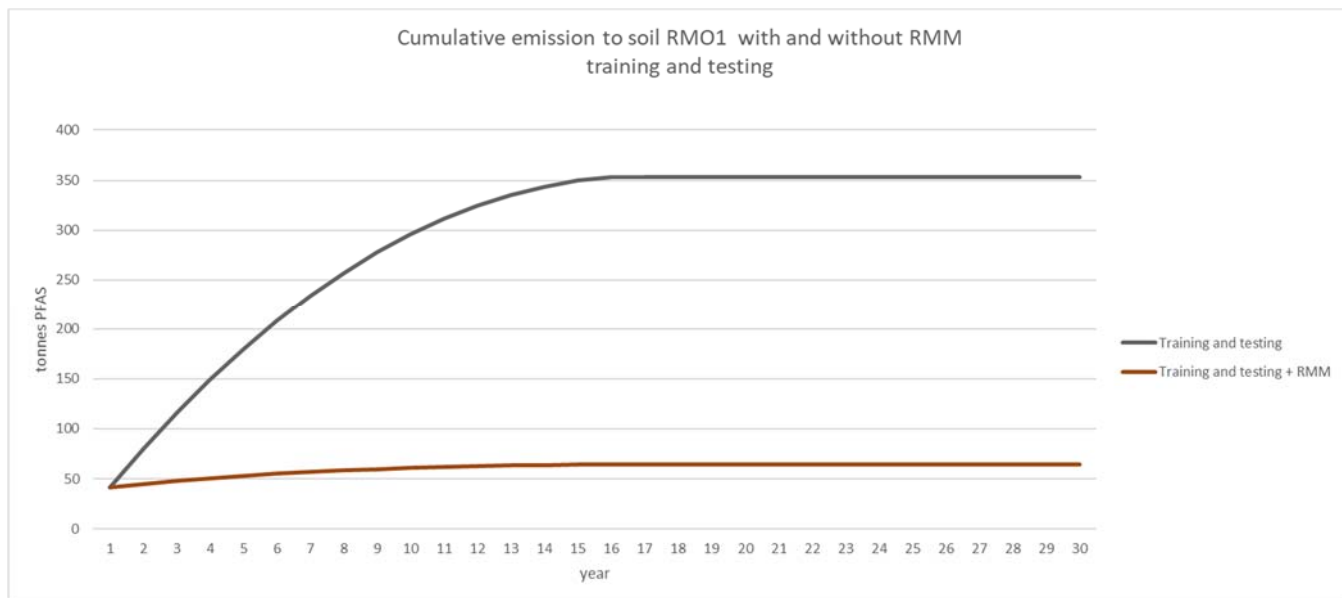

Figure 29. Cumulative emission to soil, air and surface water (t PFASs) with and without RMM for chemical / petrochemical Seveso ("Best scenario").

ANNEX XV RESTRICTION REPORT – PFAS IN FIREFIGHTING FOAMS

For testing and training, similar trend in emissions are observed. (“Best scenario”). Application of RMM gives an emission reduction of almost 300 t PFASs to soil and 270 t PFASs to surface water. Emissions to air increase by about 5 t PFASs.



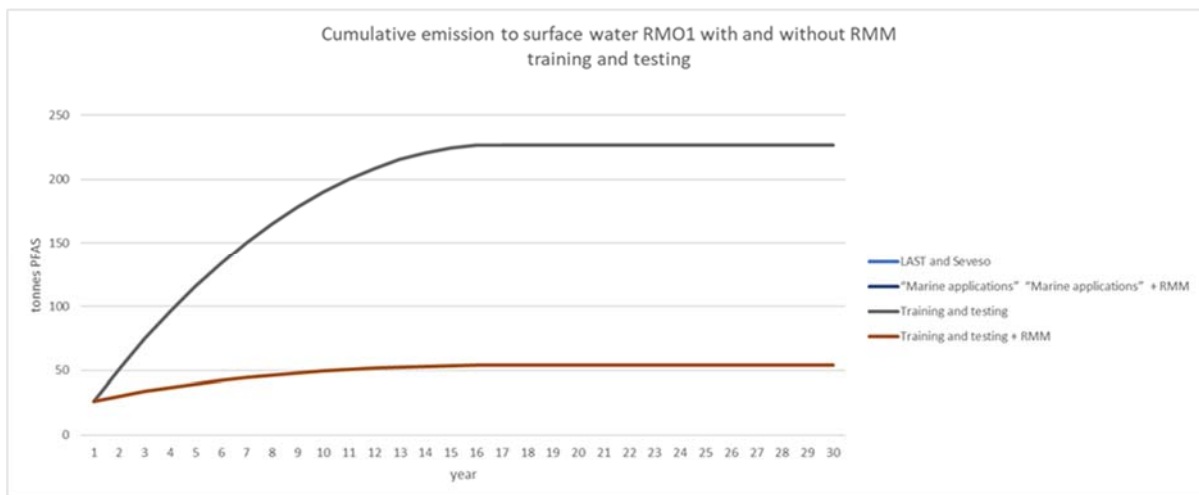
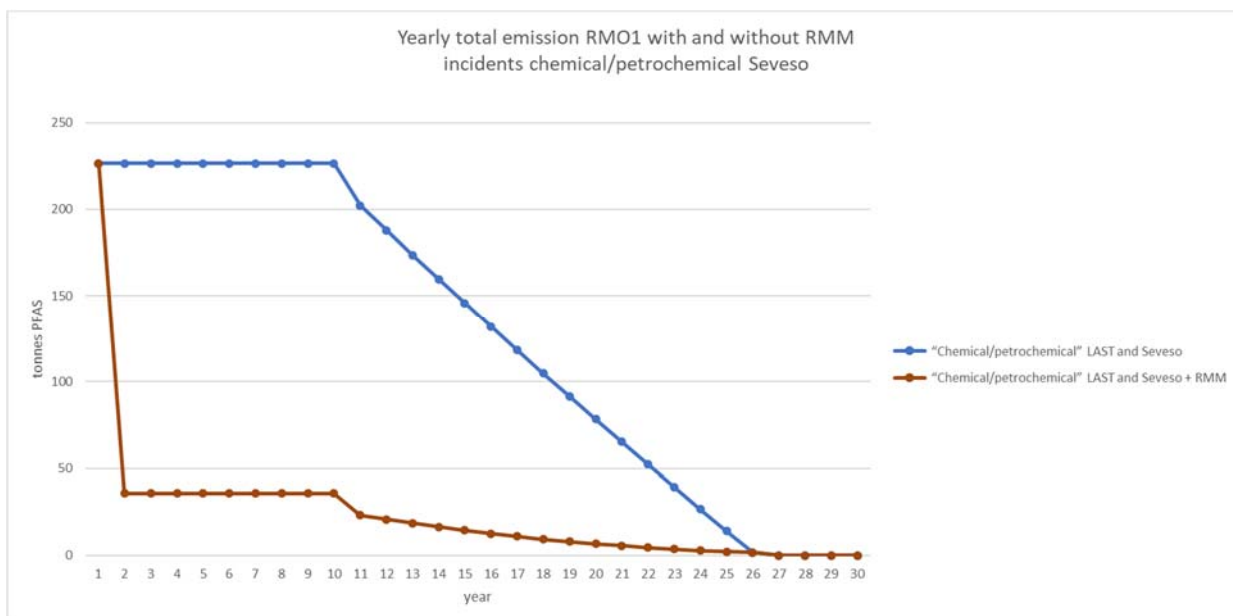

Figure 30. Cumulative emission to soil, air and surface water (t PFASs) with and without RMM for training and testing (“Best scenario”).

Figure 31 shows that the total yearly emissions as of beginning of year 2 (the year the RMM have been calculated in the Excel sheet to start³⁰) for the RO1 scenario with and without the RMM are different (in year 1 both are still identical). During the transition period (10 years for Seveso, 1.5 years for training), emissions remain constant and then decrease and stop after all remaining stock (if any) has been incinerated because the lifespan of the foam (15 years) has been reached.



³⁰ As indicated earlier, the restriction proposal suggests the RMMs to be mandatory from 6 months after entry into force, however, for the simulation in Excel, since it is built per year, for simplicity these RMMs were considered as starting to take place one year after entry into force (i.e. at the start of year 2).

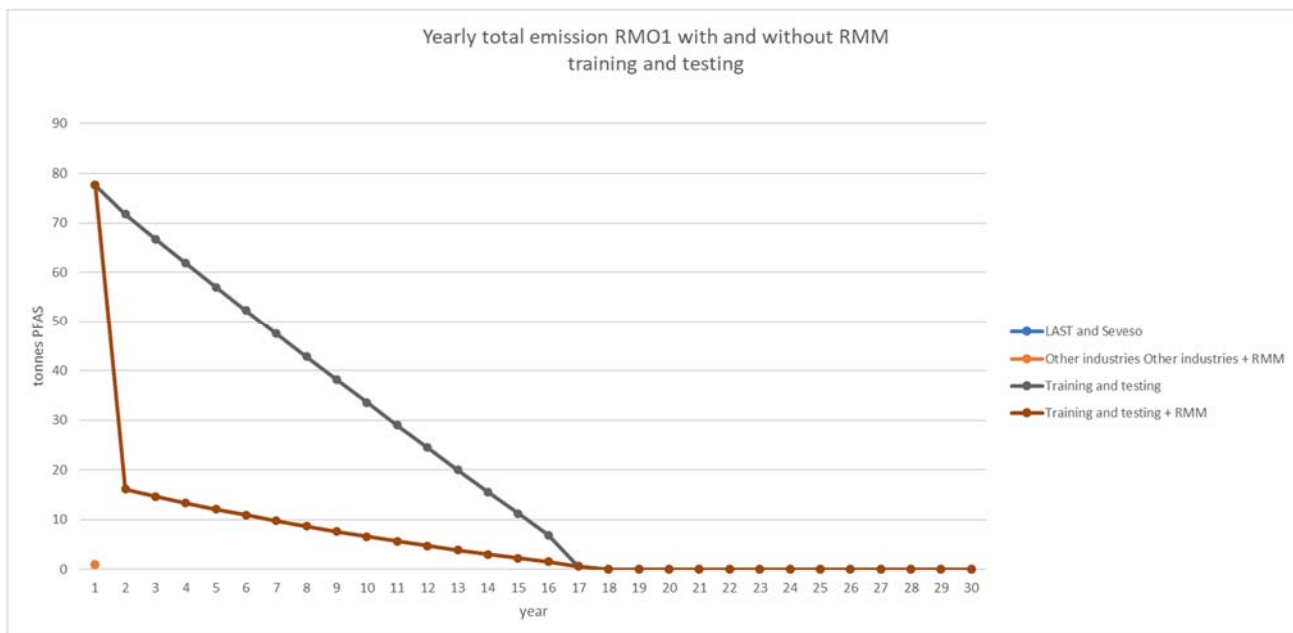

Figure 31. Total yearly emission (t PFASs) with and without RMM for chemical Seveso incidents and training and testing (“Best” estimate scenario).

Calculations of emissions for RO1 over the assessment period were performed using the input parameters listed in table in section 3 “Assumptions, uncertainties and sensitivities” of the main report as best estimate (central scenario). In addition, a sensitivity analysis has been carried out to see the effect on the results when varying one input parameter at the time, compared to the baseline scenario best estimate (Table 4 and Table 5).

Also, to identify the impact of the risk management measures proposed in the RO, the sensitivity analysis was performed for both the scenario without RMM and with RMM (where a mandatory safe disposal – assumed to be incineration- of the firewater collected from training and testing was simulated and a percentage of firewater is assumed to be collected from incidents and sent to incineration). The results are displayed in Table 4 and Table 5. This is to be compared with the baseline scenario (best estimate) where cumulative emissions of 14 109 tonnes PFASs over the assessment period was calculated.

A lower amount of cumulative emissions due to foam use corresponds to a higher amount of avoided emissions thanks to the RO.

ANNEX XV RESTRICTION REPORT – PFAS IN FIREFIGHTING FOAMS

8.7.2.2. Sensitivity analysis

Scenario **with** risk management measures

Table 4. Sensitivity analysis of avoided PFAS emissions compared to the baseline (best estimates) for RO1 varying one input parameter at the time, compared to the baseline scenario best estimate

	Low scenario			Central scenario (best estimates)		High scenario		
	Low emission value used	Resulting total avoided emissions for RO1 (compared to baseline best estimate) all sectors together over the assessment period (t PFASs)	Difference to central scenario	Emission value used	Resulting total avoided emissions for RO1 (compared to baseline best estimate) all sectors together over the assessment period (t PFASs)	High emission value used	Resulting total avoided emissions for RO1 (compared to baseline best estimate) all sectors together over the assessment period (t PFASs)	Difference to central scenario
PFAS concentration in foam concentrate (%)	2.0%	12 271	459	2.5%	11 812	3.0%	11 354	-457
annual sales (t/y)	14 000	12 322	510	18 000	11 812	20 000	11 557	-255
annual usage rate stock incidents	13 %	11 995	183	10%	11 812	5%	11 549	-263
annual usage rate stock training and testing	5 %	12 228	416	2%	11 812	1%	11 656	-156
leakage during storage	0.5%	11 955	144	1.0%	11 812	2.0%	11 528	-284
emission formulation to WWT	1.0%	11 839	28	2.0%	11 812	2.0%	11 812	0
emission formulation to air	1.25%	11 846	34	2.50%	11 812	2.50%	11 812	0
emission formulation to soil	0.005%	11 812	0	0.010%	11 812	0.010%	11 812	0
Effectiveness of WWTP for PFASs	5 %	11 829	17	0%	11 812	0%	11 812	0

ANNEX XV RESTRICTION REPORT – PFAS IN FIREFIGHTING FOAMS

Efficacy of bunding / control measures for incidents defence (%)	97 %	11 922	110	50%	11 812	0%	11 694	-117
Efficacy of bunding / control measures for incidents civil aviation (%)	97 %	11 977	166	50%	11 812	0%	11 636	-176

The sensitivity analysis shows that adjusting the emission factors for formulation and the effectiveness of “WWTPs for PFASs” only has a limited effect (< 1%) on the amount of avoided emissions. The effect of changing the percentage of “efficiency of bunding measures for incidents” for a given sector is slightly higher (~1%), but still small in relation to the total emissions avoided. A higher impact on the amount of avoided emissions is obtained when the “% PFASs in foams”, the amount of “annual sales of PFAS foams”, “leakage during storage” or “annual usage rate stock incidents and training and testing” are changed (corresponding to 1 to ~4% of the total amount of avoided emissions). From this sensitivity analysis, it can be concluded that the results are not highly determined by changes in input parameters.

ANNEX XV RESTRICTION REPORT – PFAS IN FIREFIGHTING FOAMS

Scenario **without** risk management measures

Table 5. Sensitivity analysis of avoided PFAS emissions compared to the baseline (best estimates) for RO1 varying one input parameter at the time, compared to the baseline scenario best estimate

	Low scenario			Central scenario (best estimates)		High scenario		
	Low emission value used	Resulting total avoided emissions for RO1 (compared to baseline best estimate) all sectors together over the assessment period (t PFASs)	Difference to central scenario	Emission value used	Resulting total avoided emissions for RO1 (compared to baseline best estimate) all sectors together over the assessment period (t PFASs)	High emission value used	Resulting total avoided emissions for RO1 (compared to baseline best estimate) all sectors together over the assessment period (t PFASs)	Difference to central scenario
PFAS concentration in foam concentrate (%)	2.0%	9 115	1 248	2.5%	7 867	3.0%	6 618	-1248
annual sales (t/y)	14 000	9 254	1 387	18000.00	7 867	20 000	7 173	-694
annual usage rate stock incidents	13 %	8 153	287	10%	7 867	5%	8 020	154
annual usage rate stock training and testing	5 %	8 705	838	2%	7 867	1%	7 635	-231
leakage during storage	0.5%	7 831	-36	1.0%	7 867	2.0%	7 941	75
emission formulation to WWT	1%	7 894	28	2%	7 867	2%	7 867	0
emission formulation to air	1.25%	7 901	34	2.50%	7 867	2.50%	7 867	0
emission formulation to soil	0.005%	7 867	0	0.010%	7 867	0.010%	7 867	0
Effectiveness of WWTP for PFASs	5 %	7 884	17	0%	7 867	0%	7 867	0
Efficacy of bunding / control	n/a							

ANNEX XV RESTRICTION REPORT – PFAS IN FIREFIGHTING FOAMS

measures for incidents defence (%)	
Efficacy of bunding / control measures for incidents civil aviation (%)	n/a

For RO1 without RMM the input parameters “Efficacy of bunding for incidents” are not relevant since they were included in the model calculations. The sensitivity analysis shows that adjusting the emission factors for formulation and the effectiveness of WWTPs for PFASs only has a limited effect (< 1%) on the amount of avoided emissions. Adjusting the “annual usage rate stock training and testing” can have an impact of up to 10% on the amount of emissions avoided while the change in % PFAS concentration or annual sales can even have an impact of up to 19% on the emissions avoided.

Furthermore, some observations can be made for the scenario *without RMMs*:

When the "annual usage rate stock incidents" is varied, it can be observed that both for a value of 13% and a value of 5%, lower emissions are obtained than for a value of 10%. This is due to a combination of several factors: applying a value of 5% generally results in lower emissions over the entire 30-year period (i.e. during and after the transition period). The application of 13% "annual usage stock incidents" leads to higher emissions during the transition period, but due to the higher use, the stock for Seveso, for example, is already depleted in year 22, whereas with a percentage of 10% use, emissions will continue until year 26. For this reason, the total emissions from the 10% "annual usage rate stock incidents" is higher than from the 13% use.

Another noteworthy fact is that for 'leakage during storage', more emissions occur during the 30-year period considered with a lower emission factor (0.5%) than with a higher emission factor (2%). Here too, there is an interaction of various factors. Applying a lower emission factor to leakage losses from the stock will reduce these emissions, but on the other hand, lower leakage losses will mean that more PFAS foams are used on an annual basis, which will increase emissions. This is because the model assumes that during the transition period annual sales remain constant, and that they are equal to use plus the losses (if losses decrease, use consequently increases, see Equation 4).

Comparison of sensitivity analysis between RO1 with and without RMMs

From the sensitivity analysis it can be concluded that the results of RO1 without RMM are more strongly determined by changes in the input parameters than for RO1 with RMM. Depending on the scenario considered (with or without RMMs) certain input parameters (e.g. usage rate training, leakage during storage) can have a different impact on the overall emissions reduction when they are varied in a certain direction.

Interlink between input parameters and avoided emissions

Applicable to both scenario (with and without RMMs), it should be noted that several input parameters are interlinked such as the usage rates for incidents/training and the leakage from stocks. Indeed, as described in Appendix 8, the stock has been calculated as a function of the annual sales and annual usage rate (see Equation 9), with higher usage rates leading to significant lower stocks. Therefore, a higher usage rate leads to higher emissions from incidents/testing but also to lower emissions from stock leakages.

The resulting emissions after 30 years is thus a combination of different factors, including the value of the input parameters and the way the model has been built. The low and high scenarios should be considered as one possible illustration of the impact of varying certain input parameters.

8.7.3. RO2: Ban on the placing on the market and use

8.7.3.1. Emission patterns

The avoided emissions for a period of 30 years resulting from scenario RO2 are given in Annex E.5.2. Additional illustrations of the evolution of the emissions are provided below.

It should be noted there is no visible impact of the RMM for training in RO2 in the calculations, as the RMMs have been calculated as starting in beginning of year 2, while the transition period for training and testing (1.5 years) has been calculated in a way that the emissions from this use are already over at the beginning of year 2 and the remaining stock incinerated.

Figure 32 shows the cumulative emission to soil, air and surface water with and without RMM for chemical / petrochemical Seveso incidents (“Best scenario”).

Cumulative emissions to soil, surface water and sea increase during the sector-specific transition periods. Emissions continue to increase steadily from year 2 (when the RMMs have been computed to start) until the end of the transition period, when they stop. Emissions to air also increase during the transition period, with an increased emission in the first year after the transition period because this is the year when stocks are incinerated.

As for RO1, we see that cumulative emissions to soil and surface water are lower when RMMs are applied. Cumulative emissions to air are much lower and show a different trend than emissions to soil or surface water. In contrast to RO1, due to the way they have been calculated in the model, there is no difference in emissions for training and testing with and without RMM, which is why these charts are not shown here. The emission curves to soil and surface water for RO1 and 2 differ in that for RO1 emissions continue to increase after the transition period, and for RO2 emissions stop. For incineration, both for RO1 and RO2, the effect of stock incineration can be seen at the end of the life span of the foams or after the transition period, respectively.

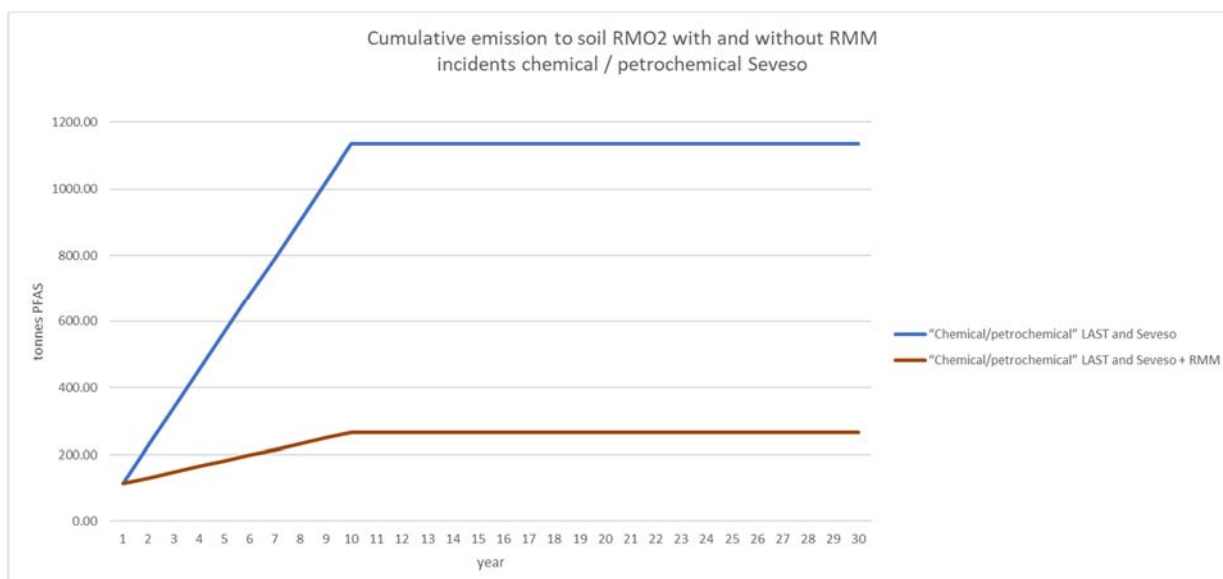

ANNEX XV RESTRICTION REPORT – PFAS IN FIREFIGHTING FOAMS

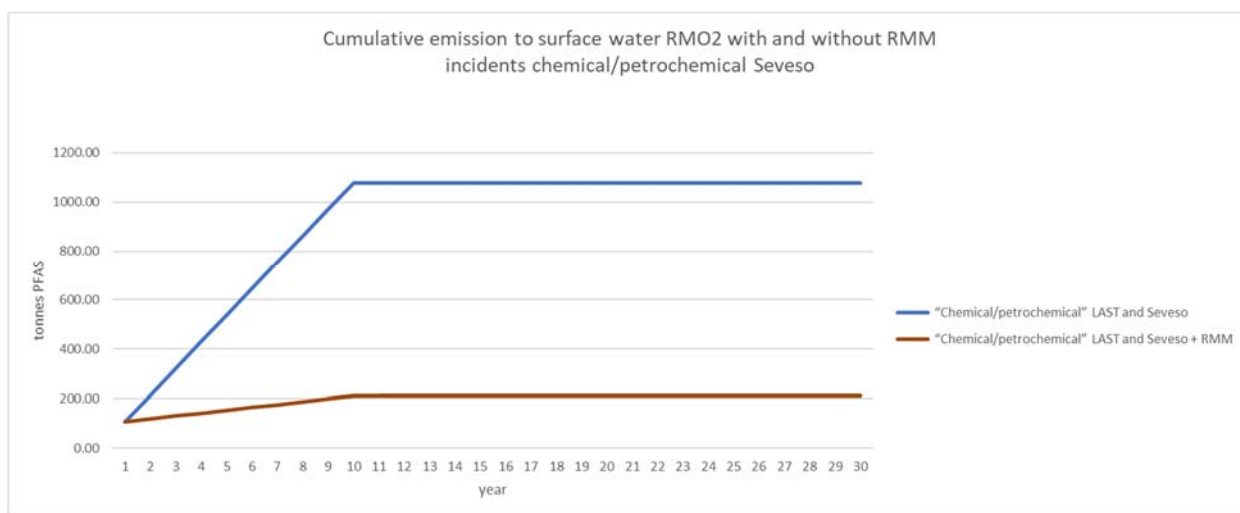
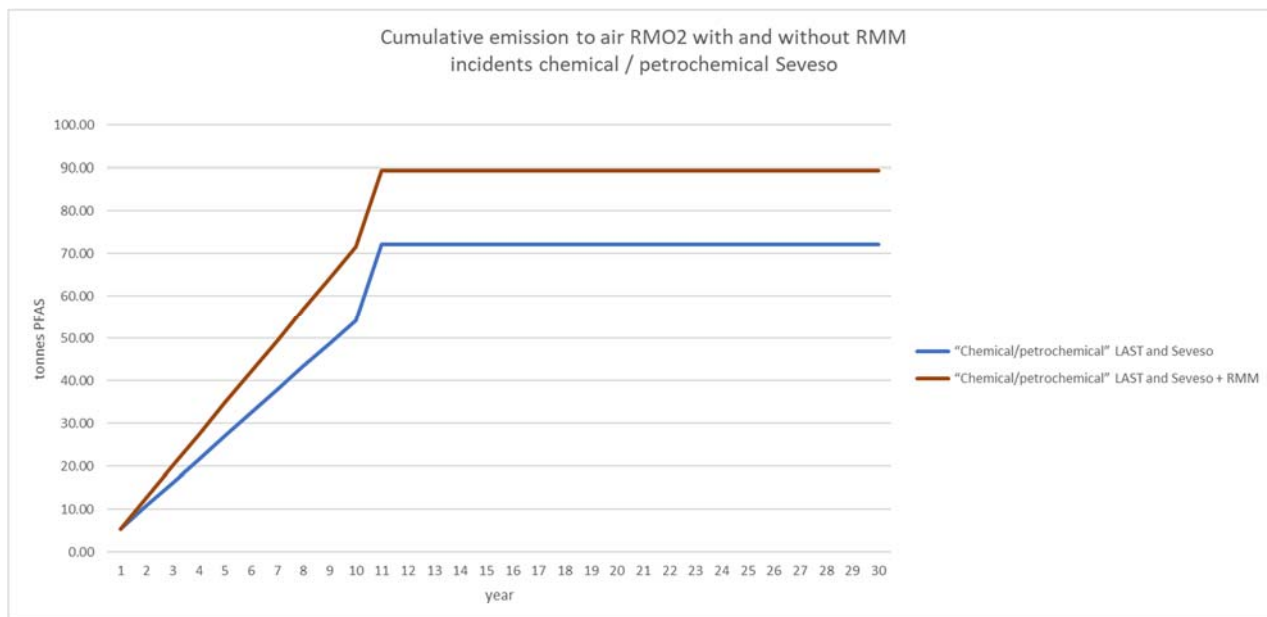

Figure 32. Cumulative emission to soil, air and surface water (t PFASs) with and without RMM for chemical / petrochemical Seveso incidents (“Best scenario”).

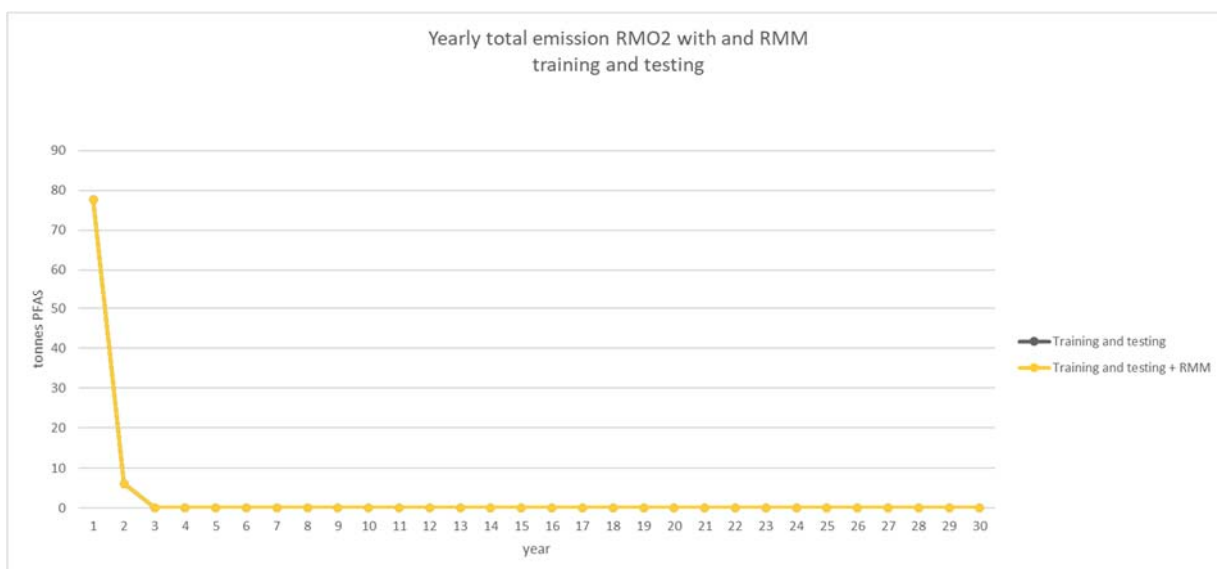
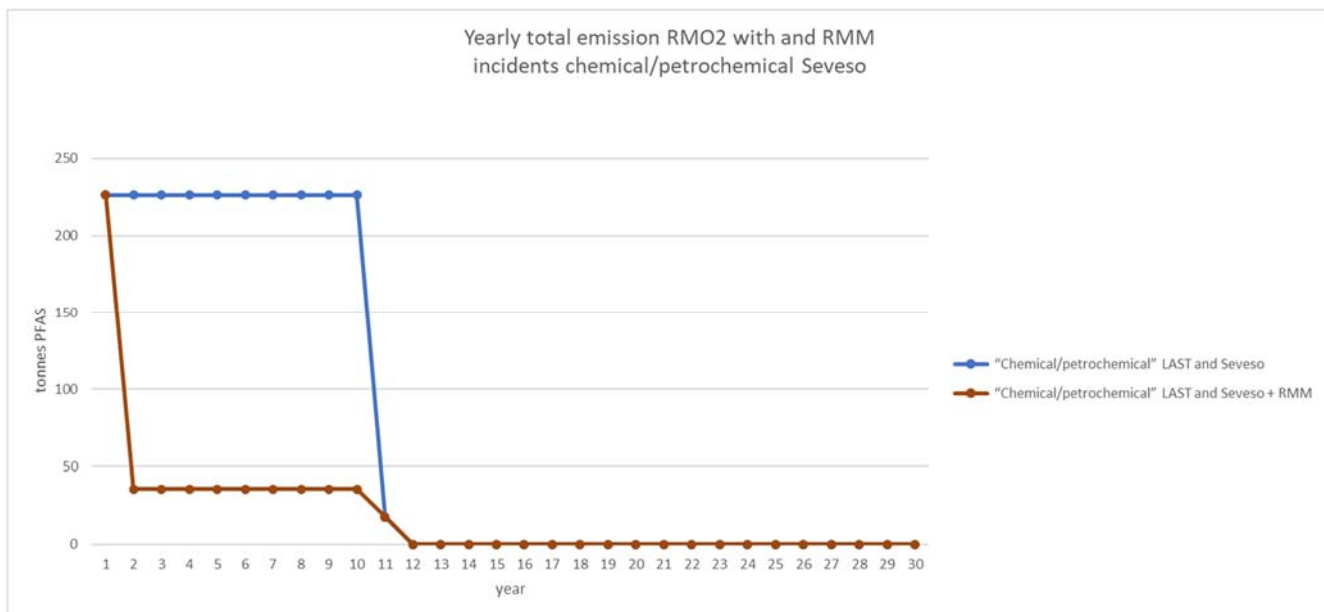

Figure 33. Total yearly emissions (t PFASs) with and without RMM for chemical Seveso incidents and training and testing (RO2, “Best” estimate scenario).

8.7.3.2. Sensitivity analysis

A sensitivity analysis was carried out to assess the impact on the results of using different input parameters, varying one input parameter at the time, compared to the baseline scenario best estimate. For RO2 this was done for the scenario with RMM (Table 6). For the baseline best scenario, an emission of 14 109 tonnes PFASs was calculated. A lower amount of cumulative emissions due to foam use corresponds to a higher amount of avoided emissions thanks to the RO. The sensitivity analysis shows that for the replacement of a parameter from the "Low" or "High" emissions estimate scenario the impact on the avoided emissions is less than 2%. From this sensitivity analysis, it can be concluded that the results are not highly determined by changes in input parameters.

ANNEX XV RESTRICTION REPORT – PFAS IN FIREFIGHTING FOAMS

Table 6. Sensitivity analysis of avoided PFAS emissions compared to the baseline (best estimates) for RO2 with RMM varying one input parameter at the time

	Low emissions estimate scenario			Central scenario (best estimates)		High emissions estimate scenario		
	Low value used	Resulting total avoided emissions for RO2 (compared to baseline best scenario best estimates) all sectors together over the assessment period (t PFASs)	Difference to central scenario	Value used	Resulting total avoided emissions for RO2 (compared to baseline best scenario best estimates) all sectors together over the assessment period (t PFASs)	High value used	Resulting total avoided emissions for RO2 (compared to baseline best scenario best estimates) all sectors together over the assessment period (t PFASs)	Difference to central scenario
PFAS concentration in foam concentrate (%)	2.0%	13 247	216	2.5%	13 031	3.0%	12 815	-216
annual sales (t/y)	14 000	13 270	240	18 000	13 031	20 000	12 911	-120
annual usage rate stock incidents	13%	13 051	20	10%	13 031	5%	12 979	-52
annual usage rate stock training and testing	5%	13 175	144	2%	13 031	1%	12 961	-70
leakage during storage	0.50%	13 114	83	1%	13 031	2%	12 864	-166
emission formulation to WWTP	1%	13 058	28	2%	13 031	2%	13 031	0
emission formulation to air	1.25%	13 065	34	2.5%	13 031	2.5%	13 031	0
emission formulation to soil	0.005%	13 031	0.1	0.01%	13 031	0.01%	13 031	0
Effectiveness of WWTP for PFASs	5%	13 048	17	0%	13 031	0%	13 031	0
Efficacy of bunding / control measures for incidents defence (%)	97%	13 069	38	50%	13 031	0%	12 990	-41
Efficacy of bunding / control measures for incidents civil aviation (%)	97%	13 089	58	50%	13 031	0%	12 970	-61

8.7.4. RO 3: Ban on the placing on the market, use and export

8.7.4.1. Emission patterns

The avoided emissions for a period of 30 years for RO 3 compared to the baseline scenario (14 109 t PFASs) are given in the Annex E.5.2. It should be underlined that, as mentioned in section 8.4 of Appendix 8 on the description of the calculations performed, the emissions model for RO3 assumed *continued* export beyond the sector-specific transitional periods. The figures obtained can be used to derive the contribution of the formulation for export to the cumulative PFAS emissions and therefore the impact of an export *ban* (see results in Annex E.5.2).

As for RO2, there is no visible impact of the RMM for training in RO3 in the calculations, as the RMMs have been calculated as starting in beginning of year 2, while the transition period for training and testing (1.5 years) has been calculated in a way that the emissions from this use are already over at the beginning of year 2 and the remaining stock incinerated.

To illustrate the contribution of the emissions from formulation from export, Figure 34 shows the cumulative total emissions for the scenario RO3 *continued export* with and without RMM ("Best scenario"). During the transition period, total emissions are the same as in RO2. The difference in total emissions between the best scenario for RO2 (formulation for export stops as the transition period for uses ends) and the simulation done for RO3 (formulation for export continues until year 30), starts in the first year after the transition periods and reaches about 120 tonnes over 30 years under the best scenario. This value gives an indication of the share of PFAS emissions from formulation for export. From there the impact of a ban of export after 10 years of transitional period can be approximated, i.e. compared to RO 2, a ban on the export would lead in additional emissions reduction of about 120 tonnes (calculated over an assessment period of 30 years). Therefore, adding these 120 tonnes of cumulative emissions further reduced to the figure obtained for RO2 under the best estimate scenario (13 031t), a figure of 13 152 tonnes of cumulative emissions of PFASs avoided due to RO3 with an export ban after a 10-years transitional period is obtained. This is the value which has been taken into account to represent the total avoided emissions for RO3 (which includes an export ban).

The graphs generated by the model considering a continued export after the transition period for use, is seen as a slight increase in the curves in Figure 34. The impact of RMMs is the same in scenario RO2 and scenario RO3 as current calculations only consider RMMs for training and incidents and not for formulation.

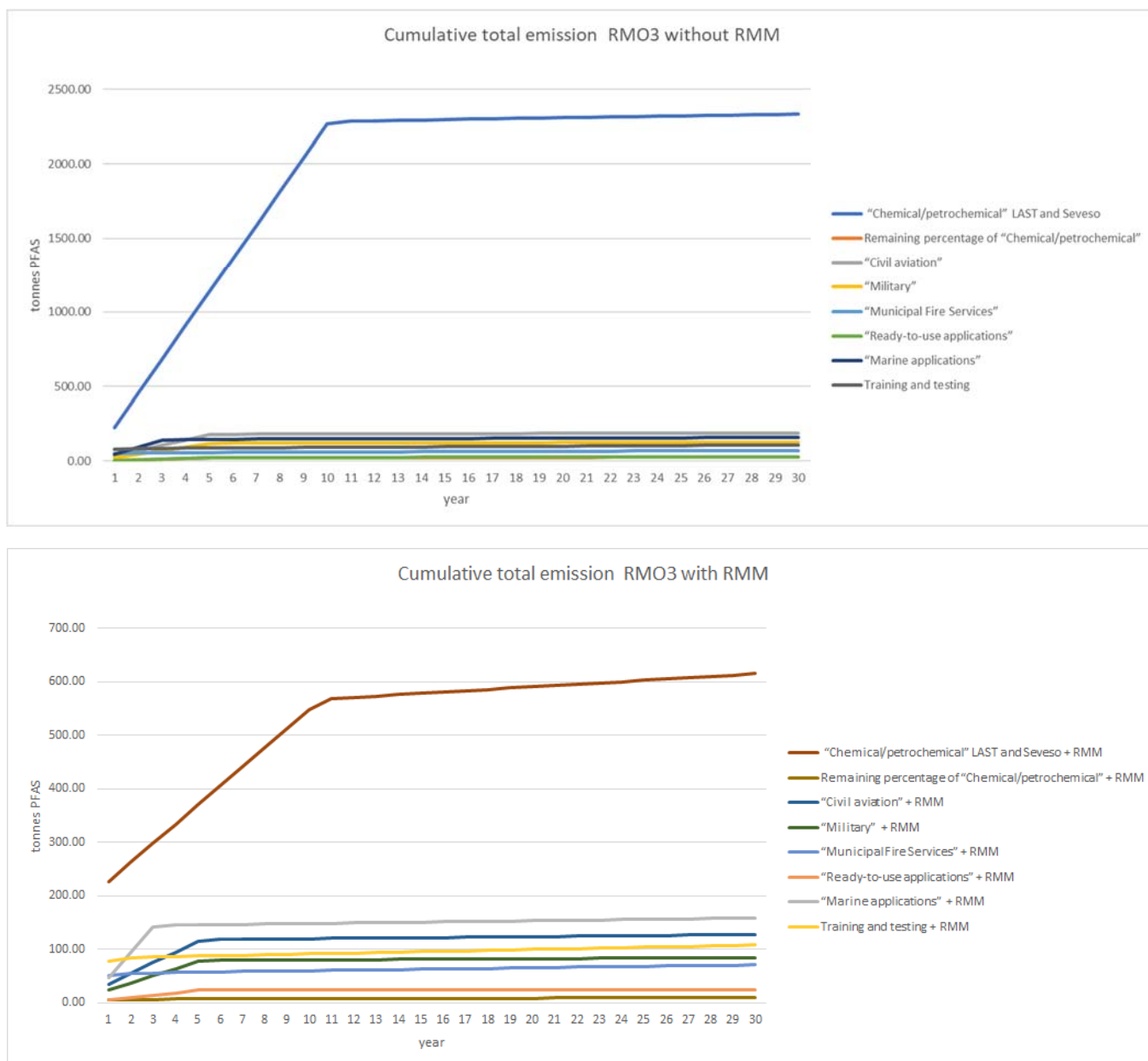

Figure 34. Cumulative total emission (t PFASs) for scenario RO3 with and without RMM (all sectors, “Best” estimate scenario), considering continued export after the transitional periods.

8.7.4.2. Sensitivity analysis

As for the other ROs, a sensitivity analysis was carried out to assess the impact on the results of using different input parameters, varying one input parameter at the time, compared to the baseline scenario best estimate. For scenario RO3 this was done for the scenario with RMM (Table 7), assuming a *continued* export. For the baseline scenario, an emission of 14 109 tonnes PFASs was calculated. A lower amount of cumulative emissions due to foam use corresponds to a higher amount of avoided emissions thanks to the RO. The sensitivity analysis shows that for the replacement of a parameter from the "Low" or "High" emissions estimate scenario the impact on the avoided emissions is no more than 2%. From this sensitivity analysis, it can be concluded that the results are not highly determined by changes in input parameters.

ANNEX XV RESTRICTION REPORT – PFAS IN FIREFIGHTING FOAMS

Table 7. Sensitivity analysis for RO3 assuming continued export: avoided PFAS emissions compared to the baseline (best estimates) varying one input parameter at the time

	Low emissions estimate scenario			Central scenario (best estimates)		High emissions estimate scenario		
	Low value used	Resulting total avoided emissions for RO3 (compared to baseline best estimates) all sectors together over the assessment period (t PFASs)	Difference to central scenario	Value used	Resulting total avoided emissions for RO3 (compared to baseline best estimates) all sectors together over the assessment period (t PFASs)	High value used	Resulting total avoided emissions for RO3 (compared to baseline best estimates) all sectors together over the assessment period (t PFASs)	Difference to central scenario
PFAS concentration in foam concentrate (%)	2%	13 150	240	2.5%	12 910	3.0%	12 670	-240
annual sales (t/y)	14 000	13 176	266	18 000	12 910	20 000	12 777	-133
annual usage rate stock incidents	13 %	12 931	21	10%	12 910	5 %	12 854	-56
annual usage rate stock training and testing	5 %	13 049	139	2 %	12 910	1 %	12 842	-68
leakage during storage	0.5%	12 993	83	1.0%	12 910	2.0 %	12 743	-166
emission formulation to WWTP	1%	12 964	54	2%	12 910	2%	12 910	0
emission formulation to air	1.25%	12 978	68	2.50%	12 910	2.50%	12 910	0
emission formulation to soil	0.005%	12 910	0.3	0.010%	12 910	0.010%	12 910	0
Effectiveness of WWTP for PFASs	5 %	12 927	17	0%	12 910	0 %	12 910	0
Efficacy of bunding / control measures for incidents defence (%)	97 %	12 948	38	50%	12 910	0 %	12 869	-41
Efficacy of bunding / control measures for incidents civil aviation (%)	97 %	12 967	58	50%	12 910	0 %	12 849	-61

8.8. RO 4: Ban on the placing on the market and use, with permit system for Seveso and defense sites

8.8.1. Emission patterns

The avoided emissions for a period are given in Annex E.5.2. Additional illustrations of the evolution of the emissions are provided below.

During the sector-specific transition periods, cumulative emissions to soil, air and surface water are the same for scenario RO4 and scenario RO2. After the transition period, emissions are the same for scenario RO4 and scenario RO2 for all sectors except the oil/chemical Seveso and defence sector. For these two sectors there is no incineration of stock in the first year after the transition period (no steep increase of emissions to air).

After the transition period, the emission curves for soil, surface water and air for scenario RO4 still increase but the curves bend over the years to reach a near-plateau; with RMMs, the increase of emissions is smaller and the bending faster.

Cumulative emissions to air are much lower but show the same trend as emissions to soil or surface water. The impact of RMMs on air emissions is relatively less pronounced compared to the relative impact on soil and surface water emissions, as collected firefighting waters are incinerated, leading to less emissions to soil and surface water but increased emissions to air. Despite this increased emission, emissions to air remain lower than those to soil and surface water.

The figures below describe the evolution of emissions for the Seveso and defence sectors.

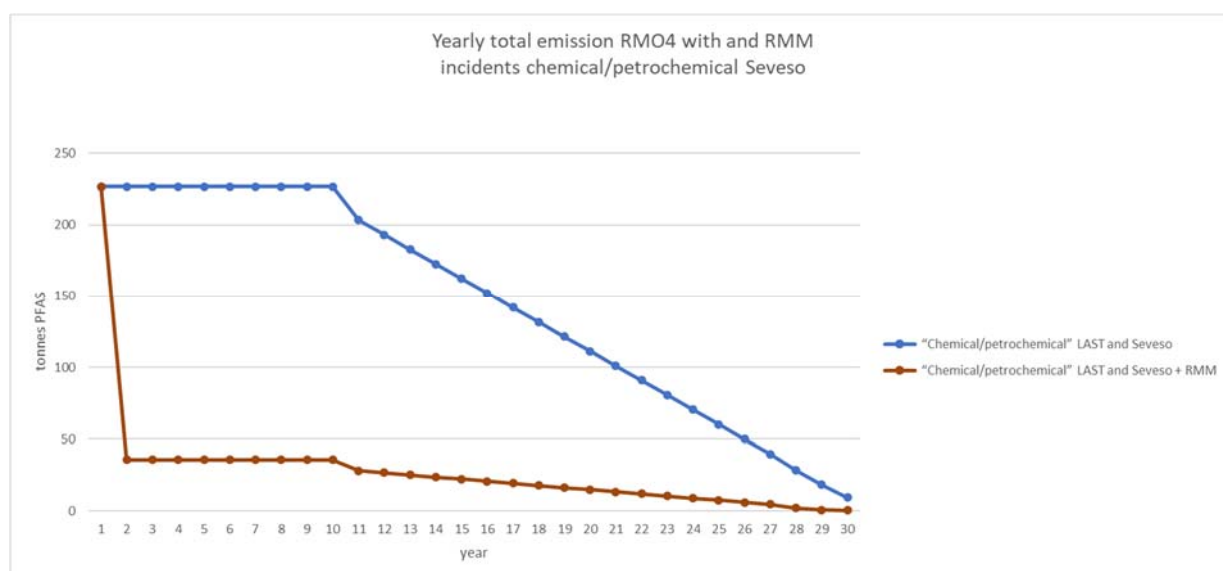

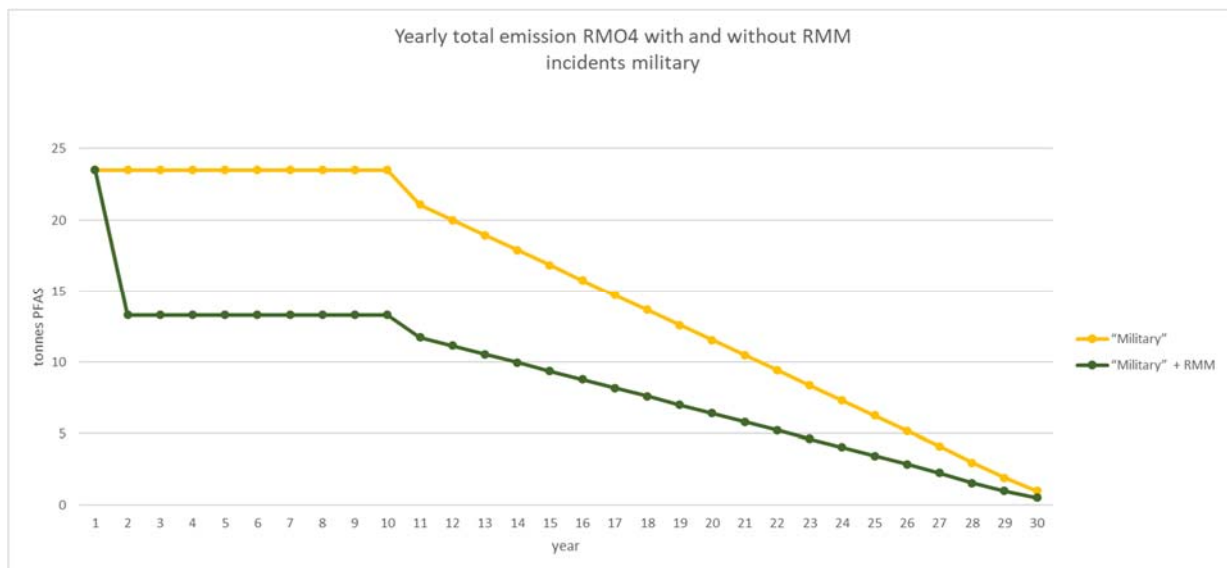
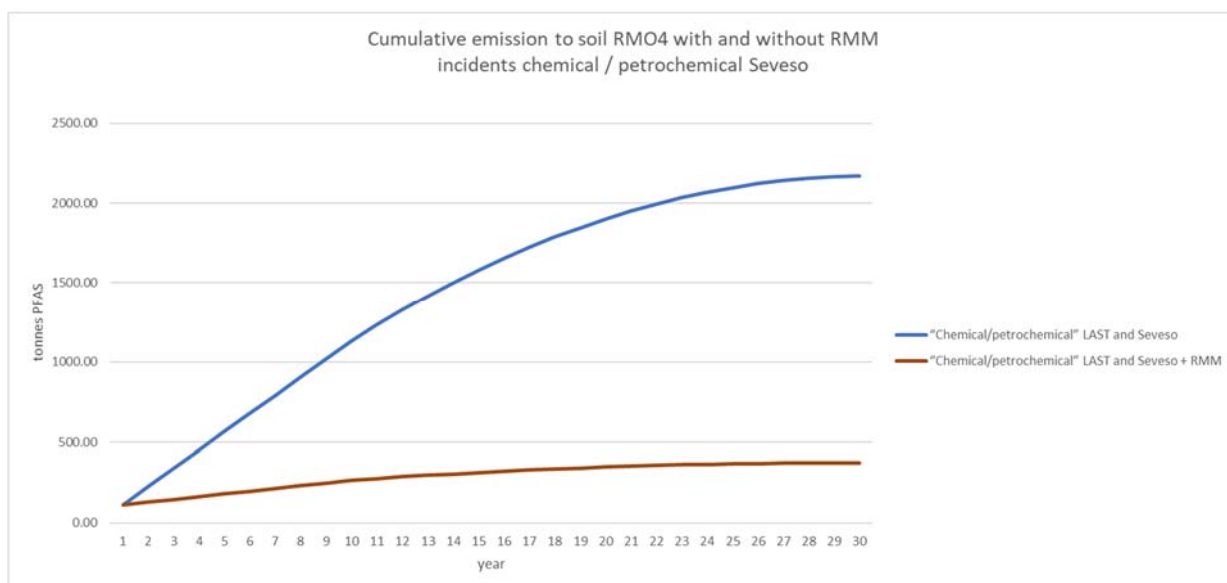

Figure 35. Total yearly emission (t PFASs) with and without RMM for chemical Seveso and military incidents (RO4, "Best" estimate scenario)



ANNEX XV RESTRICTION REPORT – PFAS IN FIREFIGHTING FOAMS

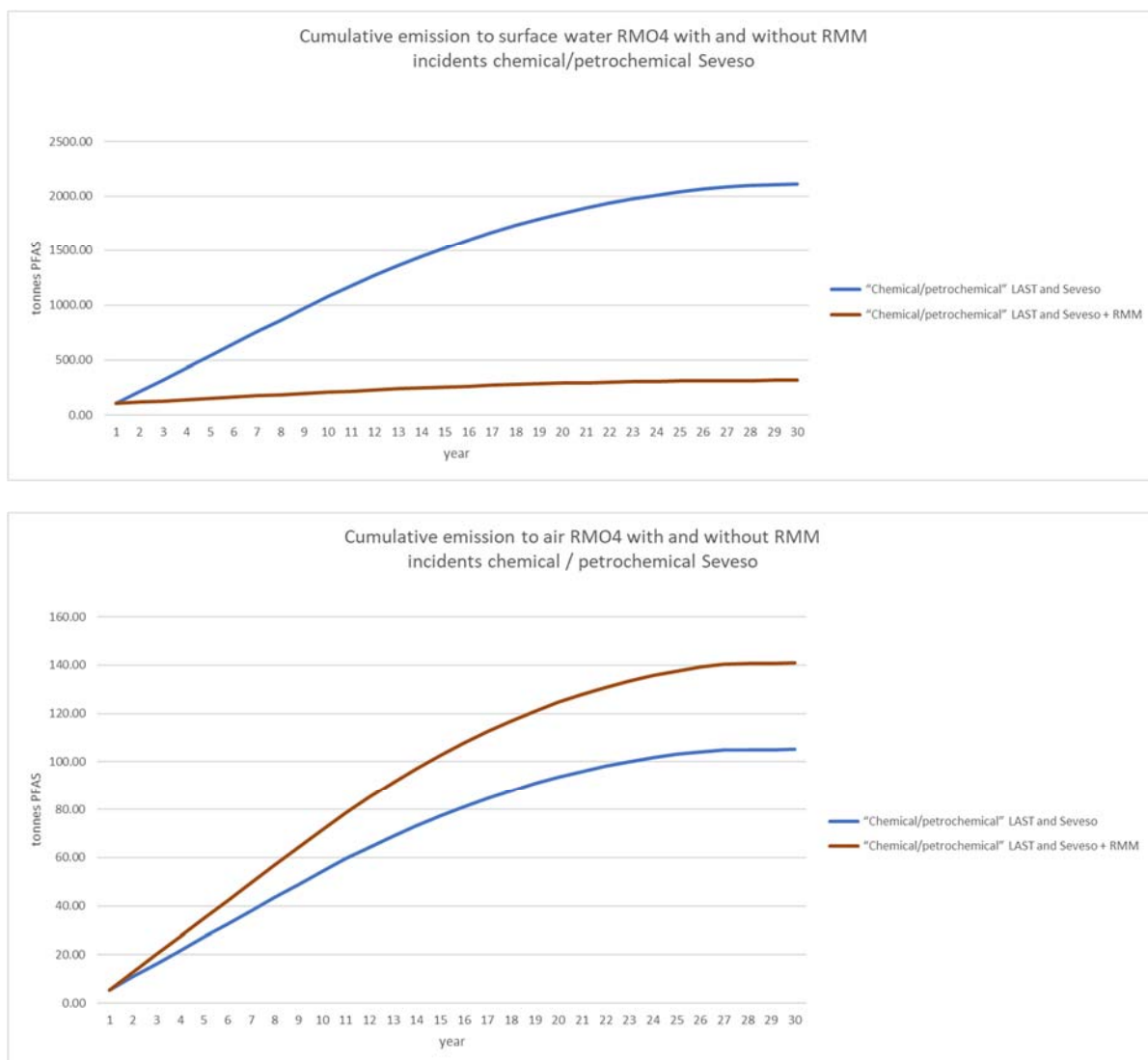

Figure 36. Cumulative emissions by environmental compartments for the chemical/petrochemical Seveso sector, with and without RMMs (RO4, "Best" estimate scenario)

ANNEX XV RESTRICTION REPORT – PFAS IN FIREFIGHTING FOAMS

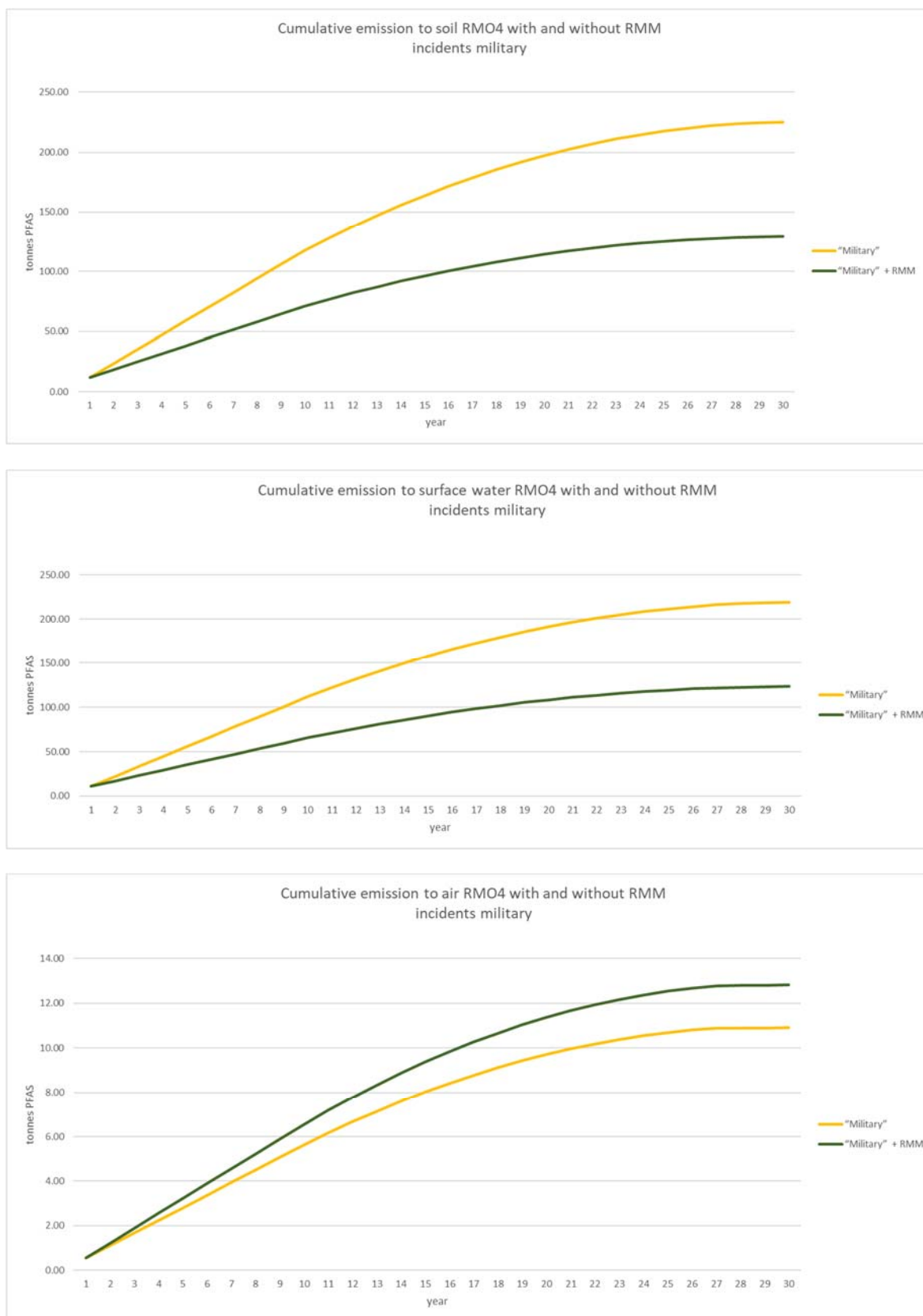

Figure 37. Cumulative emissions by environmental compartments for the defence sector, with and without RMMs (RO4, "Best" estimate scenario)

8.8.2. Sensitivity analysis

A sensitivity analysis was carried out to assess the impact on the results of using different input parameters, varying one input parameter at the time, compared to the baseline scenario best estimate. For RO4 this was done for the scenario with RMM (Table 8). For the baseline scenario, an emission of 14 109 tonnes PFASs was calculated. A lower amount of cumulative emissions due to foam use corresponds to a higher amount of avoided emissions thanks to the RO. The sensitivity analysis shows that for the replacement of a parameter from the "Low" or "High" emissions estimate scenario the impact on the avoided emissions is less than 2.6%. From this sensitivity analysis, it can be concluded that the results are not highly determined by changes in input parameters.

ANNEX XV RESTRICTION REPORT – PFAS IN FIREFIGHTING FOAMS

Table 8. Sensitivity analysis of avoided PFAS emissions compared to the baseline (best estimates) for RO4 with RMM varying one input parameter at the time

	Low emissions estimate scenario			Central scenario (best estimates)		High emissions estimate scenario		
	Low value used	Resulting total avoided emissions for RO4 (compared to baseline best estimate) all sectors together over the assessment period (t PFASs)	Difference to central scenario	Value used	Resulting total avoided emissions for RO4 (compared to baseline best estimate) all sectors together over the assessment period (t PFASs)	High value used	Resulting total avoided emissions for RO4 (compared to baseline best estimate) all sectors together over the assessment period (t PFASs)	Difference to central scenario
PFAS concentration in foam concentrate (%)	2.0%	12 884	306	2.5%	12 578	3.0%	12 272	-306
annual sales (t/y)	14 000	12 918	340	18000	12 578	20 000	12 408	-170
annual usage rate stock incidents	13%	12 600	22	10%	12 578	5%	12 532	-46
annual usage rate stock training and testing	5%	12 828	250	2%	12 578	1%	12 457	-121
leakage during storage	0.5%	12 717	139	1%	12 578	2%	12 300	-278
emission formulation to WWT	1%	12 623	45	2%	12 578	2%	12 578	0
emission formulation to air	1.25%	12 642	64	2.50%	12 578	2.50%	12 578	0
emission formulation to soil	0.005%	12 578.3	0.3	0.010%	12 578	0.010%	12 578	0
Effectiveness of WWTP for PFASs	5%	12 604	26	0%	12 578	0%	12 578	0
Efficacy of bunding / control measures for incidents defence (%)	97%	12 757	179	50%	12 578	0%	12 388	-190
Efficacy of bunding / control measures for incidents civil aviation (%)	97%	12 636	58	50%	12 578	0%	12 517	-61

8.9. RO 5: Ban on the placing on the market and use, unless full containment in place

8.9.1. Emission pattern

The avoided emissions for a period of 30 years resulting from scenario RO5 are given in Annex E.5.2 Additional illustrations of the evolution of the emissions are provided below.

Figure 38 shows the cumulative emission to soil, air and surface water with and without RMM for the chemical / petrochemical Seveso incidents (“Best scenario”).

During the sector-specific transition period, cumulative emissions to soil, air and surface water are the same for scenario RO5 and scenario RO2. After the transition period, cumulative emissions increase linearly in scenario RO5 while in RO2 they remain constant with the exception for the steep emission to air in the first year after the transition period because of the incineration of the stock. In scenario RO5 no stock is incinerated in the first year after the transition period of the oil/(petro)chemical Seveso sector. For this sector, the increase in cumulative emissions to soil, air and surface water is a little larger during the transition period in comparison to the years after the transition period when stricter RMMs are used; the difference can hardly be noticed on the curves in Figure 38 but is clearly shown in the yearly emissions (see Annex E.5.2). The impact of RMMs on air emissions is relatively less pronounced compared to the relative impact on soil and surface water emissions, as collected firefighting waters are incinerated, leading to less emissions to soil and surface water but increased emissions to air (but still less than with the ‘light’ RMMs). Despite this increased emission, emissions to air remain lower than those to soil and surface water.

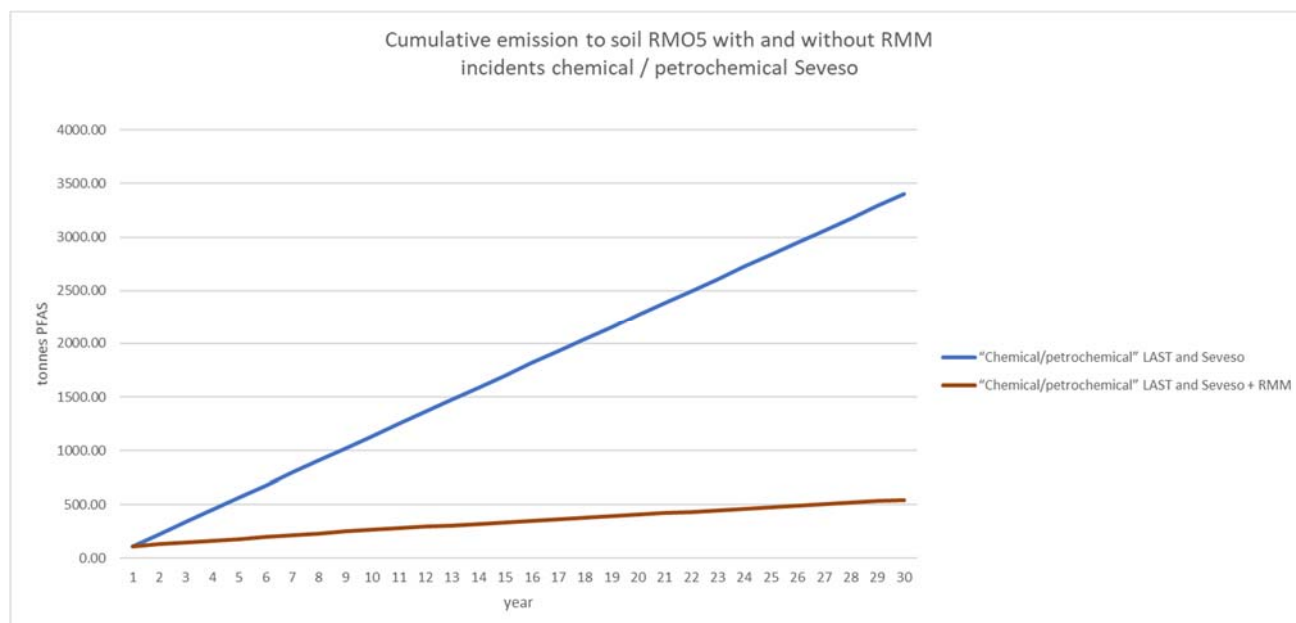

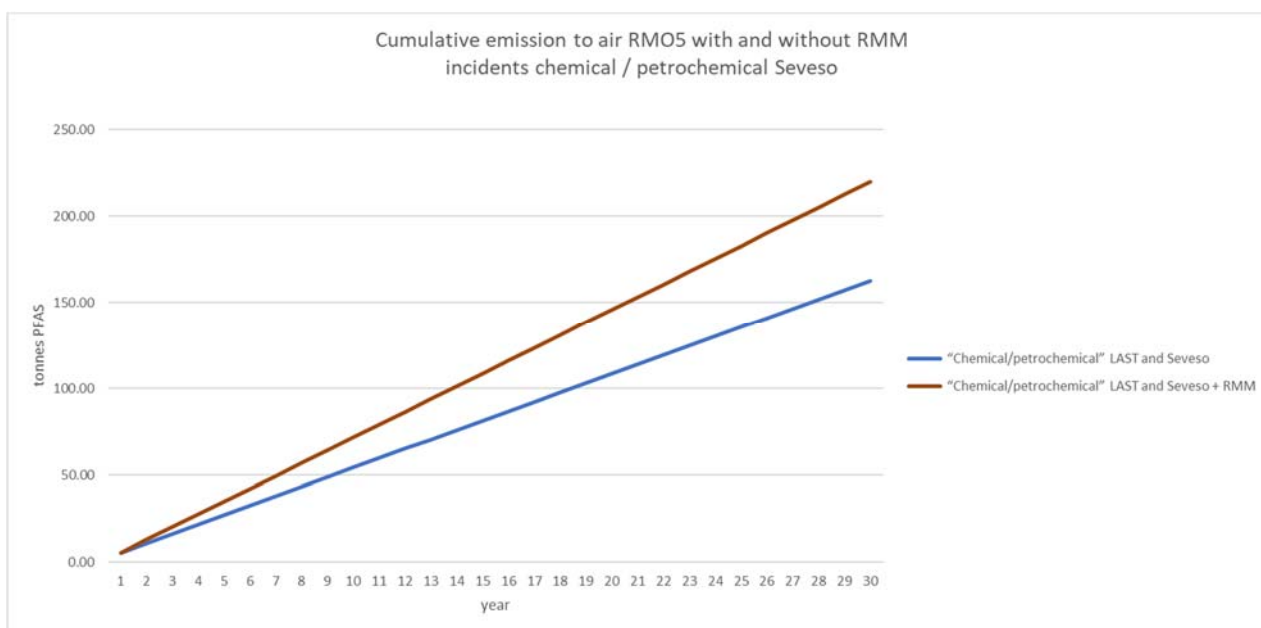
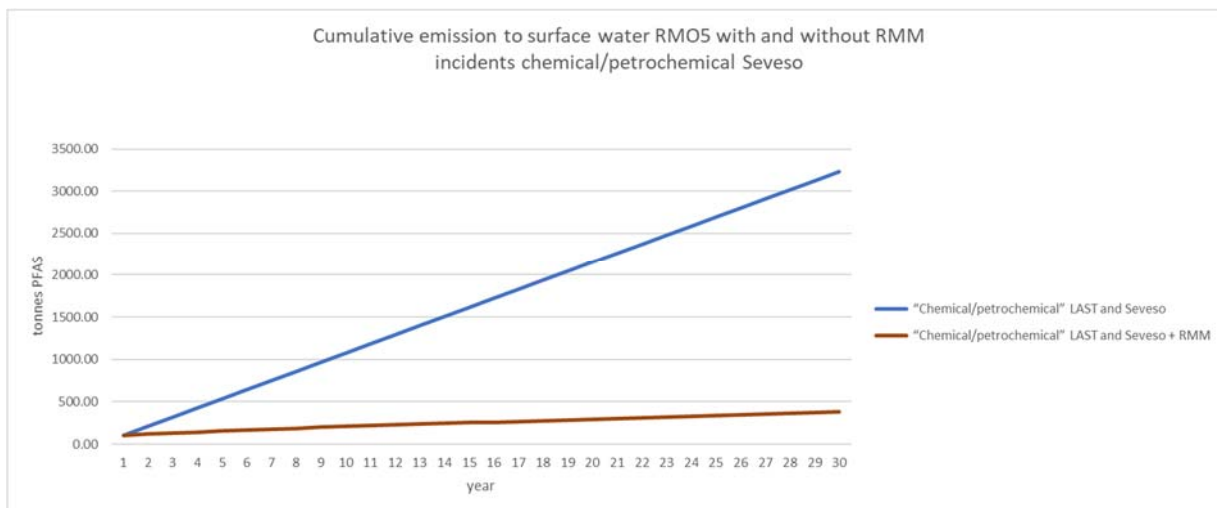

Figure 38. cumulative emissions for Seveso sector to soil, water and air under RO5 with and without RMMs.

8.9.2. Sensitivity analysis

A sensitivity analysis was carried out to assess the impact on the results of using different input parameters, varying one input parameter at the time, compared to the baseline scenario best estimate. For RO5 this was done for the scenario with RMM (Table 9). For the baseline scenario, an emission of 14 109 tonnes PFASs was calculated. A lower amount of cumulative emissions due to foam use corresponds to a higher amount of avoided emissions thanks to the RO. The sensitivity analysis shows that for the replacement of a parameter from the "Low" or "High" emissions estimate scenario the impact on the avoided emissions is less than 3%. From this sensitivity analysis, it can be concluded that the results are not highly determined by changes in input parameters.

ANNEX XV RESTRICTION REPORT – PFAS IN FIREFIGHTING FOAMS

Table 9. Sensitivity analysis of avoided PFAS emissions compared to the baseline (best estimates) for RO5 with RMM varying one input parameter at the time

	Low emissions estimate scenario			Central scenario (best estimates)		High emissions estimate scenario		
	Low value used	Resulting total avoided emissions for RO5 (compared to baseline best estimates) all sectors together over the assessment period (t PFASs)	Difference to central scenario	Value used	Resulting total avoided emissions for RO5 (compared to baseline best estimates) all sectors together over the assessment period (t PFASs)	High value used	Resulting total avoided emissions for RO5 (compared to baseline best estimates) all sectors together over the assessment period (t PFASs)	Difference to central scenario
PFAS concentration in foam concentrate (%)	2.00%	12 783	331	2.50%	12 452	3.00%	12 121	-331
annual sales (t/y)	14 000	12 820	368	18000	12 452	20 000	12 268	-184
annual usage rate stock incidents	13%	12 520	68	10%	12 452	5%	12 272	-181
annual usage rate stock training and testing	5%	12 767	315	2%	12 452	1%	12 296	-156
leakage during storage	0.50%	12 714	262	1.00%	12 452	2.00%	11 928	-524
emission formulation to WWTP	1%	12 523	71	2%	12 452	2%	12 452	0
emission formulation to air	1.25%	12 541	89	2.50%	12 452	2.50%	12 452	0
emission formulation to soil	0.005%	12 452.5	0.3	0.010%	12 452	0.010%	12 452	0
Effectiveness of WWTP for PFASs	5%	12 491.7	40	0%	12 452	0%	12 452	0
Efficacy of bunding / control measures for incidents defence (%)	97%	12 491	38	50%	12 452	0%	12 411	-41
Efficacy of bunding / control measures for incidents civil aviation (%)	97%	12 510	58	50%	12 452	0%	12 391	-61

8.10. Cumulative emissions per use/sector under the five ROs

8.10.1. Cumulative emissions for the five ROs with RMMs

Below are presented the cumulative emissions of PFASs over 30 years under the different scenarios for the five ROs with RMMs

Table 10. cumulative emissions of PFASs over 30 years under the BEST scenario for the five ROs with RMMs

Sector/type of use	RO1 (tonnes)	RO2 (tonnes)	RO3 (tonnes)	RO4 (tonnes)	RO5 (tonnes)
Seveso establishments	711	566	517	833	1145
Other industries	11	8	7	8	8
Civil aviation	248	118	108	118	118
Defence	166	79	72	265	79
Municipal fire services	434	55	39	55	55
Ready-to-use applications	57	24	23	24	24
Marine applications	472	145	131	145	145
Training and testing	199	84	59	84	84
All sectors	2297	1078	957	1531	1657

Table 11. cumulative emissions of PFASs over 30 years under the LOW scenario for the five ROs with RMMs

Sector/type of use	RO1 (tonnes)	RO2 (tonnes)	RO3 (tonnes)	RO4 (tonnes)	RO5 (tonnes)
Seveso establishments	245	217	204	300	347
Other industries	4	3	3	3	3
Civil aviation	30	26	23	26	26
Defence	20	17	16	31	17
Municipal fire services	185	28	24	28	28
Ready-to-use applications	30	14	14	14	14
Marine applications	208	76	72	76	76
Training and testing	153	80	67	80	80
All sectors	875	462	423	559	592

Table 12. cumulative emissions of PFASs over 30 years under the HIGH scenario for the five ROs with RMMs

Sector/type of use	RO1 (tonnes)	RO2 (tonnes)	RO3 (tonnes)	RO4 (tonnes)	RO5 (tonnes)
Seveso establishments	2122	1415	1350	2204	3619
Other industries	31	17	15	17	17
Civil aviation	570	243	231	243	243
Defence	380	162	154	536	162
Municipal fire services	584	79	58	79	79
Ready-to-use applications	76	32	31	32	32
Marine applications	633	199	180	199	199
Training and testing	437	120	88	120	120
All sectors	4833	2268	2106	3430	4471

8.10.2. Cumulative emissions for the five ROs without RMMs

Below are presented the cumulative emissions of PFASs over 30 years under the different scenarios for the five ROs without RMMs

Table 13. cumulative emissions of PFASs over 30 years under the BEST scenario for the five ROs without RMMs

Sector/type of use	RO1 (tonnes)	RO2 (tonnes)	RO3 (tonnes)	RO4 (tonnes)	RO5 (tonnes)
Seveso establishments	3860	2284	2235	4387	6798
Other industries	56	23	22	23	23
Civil aviation	424	179	170	179	179
Defence	283	119	113	455	119
Municipal fire services	434	55	39	55	55
Ready-to-use applications	57	24	23	24	24
Marine applications	472	145	131	145	145
Training and testing	657	84	59	84	84
All sectors	6242	2913	2792	5353	7428

Table 14. Cumulative emissions of PFASs over 30 years under the LOW scenario for the five ROs without RMMs

ANNEX XV RESTRICTION REPORT – PFAS IN FIREFIGHTING FOAMS

Sector/type of use	RO1 (tonnes)	RO2 (tonnes)	RO3 (tonnes)	RO4 (tonnes)	RO5 (tonnes)
Seveso establishments	1837	1200	1187	2397	3580
Other industries	25	12	12	12	12
Civil aviation	193	94	91	94	94
Defence	129	63	61	249	63
Municipal fire services	185	28	24	28	28
Ready-to-use applications	30	14	14	14	14
Marine applications	208	76	72	76	76
Training and testing	544	80	67	80	80
All sectors	3149	1567	1528	2950	3947

Table 15. Cumulative emissions of PFASs over 30 years under the HIGH scenario for the five ROs without RMMs

Sector/type of use	RO1 (tonnes)	RO2 (tonnes)	RO3 (tonnes)	RO4 (tonnes)	RO5 (tonnes)
Seveso establishments	5176	3081	3016	5182	9101
Other industries	75	32	30	32	32
Civil aviation	570	243	231	243	243
Defence	380	162	154	538	162
Municipal fire services	584	79	58	79	79
Ready-to-use applications	76	32	31	32	32
Marine applications	633	199	180	199	199
Training and testing	881	120	88	120	120
All sectors	8374	3948	3787	6425	9968

Appendix 9. Sensitivity calculations for and time profile of costs

9.1. RO1: Ban on the placing on the market, use allowed

Sensitivity analysis

As for emissions, a sensitivity analysis was performed to assess the impact on the cost results of using different input parameters (Table 16).

To check the robustness of the cost estimations, the parameters in the "Best" estimate scenario were changed one by one to the corresponding value for the "Low" or "High" estimate scenario. The low and high value do not represent the absolute extremes, but a reasonable range to describe the relevance of that input parameter to the overall results. The total cost was calculated as the balance of the discounted sum (i.e. the net present value) of additional (i.e. incremental) costs and cost savings in RO1 compared to the baseline scenario.

As it was assumed that for the baseline scenario there is a steady state, the situation over 30 years remains the same as in year 0; therefore, the (undiscounted) total costs over a period of 30 years are equal to thirty times the total costs in year 0. Finally, the difference is calculated between the additional costs for the 'Best' estimate scenario and the scenario in which one parameter is changed to the corresponding parameter in the 'Low' or 'High' estimate scenario.

ANNEX XV RESTRICTION REPORT – PFAS IN FIREFIGHTING FOAMS

Table 16: Sensitivity analysis of costs (net present values) for RO1 (ban on the placing on the market, with low, best and high estimates) with RMM.

	Low scenario			Central scenario (best estimates)		High scenario		
	Low value used	Resulting total costs (NPV) for RO1 all sectors together over the assessment period (€)	Difference to central scenario	Value used	Resulting total costs (NPV) for RO1 all sectors together over the assessment period (€)	High value used	Resulting total costs (NPV) for RO1 all sectors together over the assessment period (Mio. €)	Difference to central scenario
Parameters having an effect on emissions and potentially also on costs	Low emission value			Central value		High emission value		
PFAS concentration in foam concentrate (%)	2.00%	5 876 965 275	0	2.50%	5 876 965 275	3.00%	5 876 965 275	0
annual sales (t/y)	14 000	5 795 104 397	-81 860 878	18 000	5 876 965 275	20 000	5 917 895 714	40 930 439
annual usage rate stock incidents	13.00%	6 012 536 408	135 571 133	10.00%	5 876 965 275	5.00%	5 640 384 595	-236 580 680
annual usage rate stock training and testing	5.00%	5 992 232 921	115 267 646	2.00%	5 876 965 275	1.00%	5 828 760 343	-48 204 932
leakage during storage	0.50%	5 880 972 015	4 006 740	1.00%	5 876 965 275	2.00%	5 868 087 110	-8 878 165
emission formulation to WWT	1.00%	5 876 965 275	0	2.00%	5 876 965 275	2.00%	5 876 965 275	0
emission formulation to air	1.25%	5 876 965 275	0	2.50%	5 876 965 275	2.50%	5 876 965 275	0
emission formulation to soil	0.005%	5 876 965 275	0	0.010%	5 876 965 275	0.01%	5 876 965 275	0

ANNEX XV RESTRICTION REPORT – PFAS IN FIREFIGHTING FOAMS

Effectiveness of WWTP for PFASs	5.00%	5 876 965 275	0	0.00%	5 876 965 275	0.00%	5 876 965 275	0
Efficacy of bunding / control measures for incidents military (%)	97.00%	5 882 541 019	5 575 744	50.00%	5 876 965 275	0.00%	5 871 033 633	-5 931 642
Efficacy of bunding / control measures for incidents civil aviation (%)	97.00%	5 880 251 568	3 286 293	50.00%	5 876 965 275	0.00%	5 873 469 219	-3 496 056
Parameters having an effect on costs only	Low cost value			Central value	5 876 965 275	High cost value		
Incineration/disposal costs per liter of foam (not relevant for RO1)	900 €/ tonne	5 876 965 275	0	1 000 €/tonne	5 876 965 275	1 250 €/ tonne	5 876 965 275	0
Average price €/tonne of PFAS-based foam	3 750 €/tonne	5 749 281 678	-127 683 597	3 000 €/tonne	5 876 965 275	2 700 €/tonne	5 928 038 714	51 073 439
Average price €/tonne of fluorine-free foam	2 700 €/tonne	5 800 355 117	-76 610 158	3 000 €/tonne	5 876 965 275	3 750 €/tonne	6 068 490 670	191 525 395
Additional volumes required % increase over PFAS based foams	+25% required	5 749 281 678	-127 683 597	+50% required	5 876 965 275	+75% required	6 004 648 871	127 683 596
Savings from avoided clean-up	Gradually increasing to €20 million per year	5 804 245 589	-72 719 686	Gradually increasing to €10 million per year	5 876 965 275	Gradually increasing to €5million per year	5 913 325 118	36 359 843
Cleaning costs per site (number of sites per sectors is not varied)	-50% in total cleaning costs	4 861 127 072	-1 015 838 203	Sector-specific, see Section 3 of the Annex XV report	5 876 965 275	+100% in total cleaning costs	7 908 641 681	2 031 676 406
Cleaning costs per site to achieve a threshold of 1 ppb (considered to be 10 times higher than				Sector-specific, see Table 14	5 876 965 275	+900% in total cleaning costs	24 162 052 933	18 285 087 658

ANNEX XV RESTRICTION REPORT – PFAS IN FIREFIGHTING FOAMS

for a threshold of 1 ppm)								
Cost of technical change per site	-50% for all sectors	4 102 147 973	-1 774 817 302	Sector-specific, see Section 3 of the Annex XV report	5 876 965 275	+200% for all sectors	12 976 234 484	7 099 269 209
Costs of technical means to contain releases and disposal of PFAS-contaminated water from the fire-water run-off from testing/training and incidents	-50%	5 820 461 897	-56 503 378	€ 1/liter of foam	5 876 965 275	+100%	5 989 972 031	113 006 756

Blue cells: reduction in costs; red cells: increase in costs; grey cells: no change in costs; yellow cells: best estimate for comparison

ANNEX XV RESTRICTION REPORT – PFAS IN FIREFIGHTING FOAMS

The sensitivity analysis shows that there are indeed some parameters defining the low and high emission scenarios that simultaneously have an effect on the amount of costs. The effect of these cases is, however, heterogeneous and ambiguous:

- A reduction of annual sales compared to the baseline leads to a higher reduction of emission but also less costs, and vice versa.
- A higher annual usage rate of the stock, both for incidence and for training and testing, leads to a higher reduction of emissions but also an increase in costs, and vice versa.
- A lower leakage rate during storage leads to a higher reduction of emission but also to increased costs, and vice versa.
- A higher efficacy of bunding and control measures for incidents in the military or the civil aviation sector leads to more emission reduction but also higher cost, and vice versa.
- The percentage PFAS concentration in foam concentrate does not have an effect on costs according to the model assumptions, since costs are related to foam quantities but not the share of PFAS contained.
- Emission formulation factors to WWT, air and soil and effectiveness of WWTP for PFASs do not have an effect on the costs.
- The highest sensitivity of this group of parameters is observed for the annual usage rate of stock for incidents.

For the group of parameters having an influence only on the calculation of costs but not on emissions the sensitivity varies significantly among the input parameters:

- The highest influence on costs (due to high uncertainty) is due to the (sector-specific) costs of technical change per site (decrease by 30% and increase by 121%).
- Also the (sector-specific) cleaning costs per site have a high effect on the overall costs (decrease by 17% and increase by 35%).

In the separately calculated assumption of a more stringent concentration threshold of 1 ppt (which is not used as part of the “high” scenario), in order to illustrate the cost-effectiveness of a more stringent concentration threshold, a cost estimate is derived also for a 1 ppb threshold with a following assumptions:

- SEVESO: €2 000 000 per site.
- Civil aviation and military: €500 000 per site
- Other sectors: €200 000 per site.
- Training and testing and ready to use applications: not relevant

These assumptions are based on following considerations:

- According to industry the cleaning cost heavily depends on the thresholds to achieve. 1 ppb is 1 000 times less than 1 ppm.
- A large company in the chemical sector indicated that there would be costs of around €1 500 000 per installed system and the highest costs for vehicles reported is €100 000 – 200 000.
- In absence of more precise information, the cost of achieving the threshold of 1 ppb is considered to be 10 times higher than 1 ppm.

With these assumptions the cleaning costs increase by a factor of more than 300 % compared to the central value of incremental costs.

From this sensitivity analysis, it can be concluded that adjusting cost factors has in most cases (apart from the technical changes and the cleaning costs which are specific to the sectors) only a small effect on the incremental costs (-4.0% up to 3.2%). The cost reduction of 4.0% pertains to a reduction of the annual usage rate of stock for incidents from 10% to 5%, the increase of 3.2% pertains to an increase of the average price per ton of fluorine-free foam from 3 000 €/tonne to 3 750 €/tonne.

Time profile of costs

The time profile of the different cost categories over 30 years is shown in Figure 39.

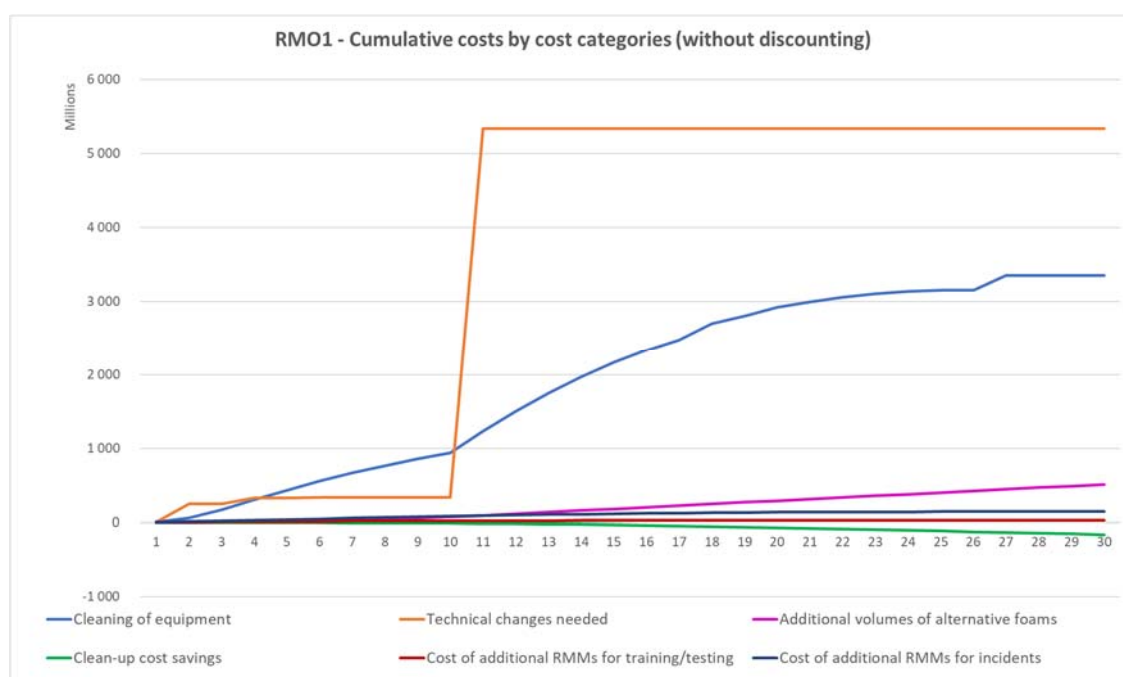

Figure 39: Cumulative costs of each cost category for scenario RO1 (all sectors, “Best” estimate scenario, without discounting).

In a different way from the calculation of net present values, Figure 39 does not use discounting for costs occurring in the future. So it can be seen that the additional volumes for alternative foams increase linearly after year 11, when the last transition period for the sector of chemical/ petrochemical industry (Seveso) have ended. This means that additional costs remain constant for each year. The same holds for the cost savings due to avoided clean-up. A characteristic of RO1 is that use of PFAS-based foams continues for several years after the end of the transition periods until the stock is completely exhausted. Therefore, cleaning of equipment is executed at the different sites over a longer period of time.

9.2. RO2: Ban on the placing on the market and use

Sensitivity analysis

As for emissions, a sensitivity analysis was performed to assess the impact on the cost results of using different input parameters (Table 17).

The same way as for RO1, the parameters in the "Best" estimate scenario were changed one by one to the corresponding value for the "Low" or "High" estimate scenario. The low and high value represent a reasonable range to describe the relevance of that input parameter to the overall results. The total cost is the balance of the discounted sum (i.e. the net present value) of incremental costs and cost savings in RO2 compared to the baseline scenario (million €).

The baseline scenario represents a steady state, a situation at constant levels over 30 years, which also refers to annual costs. Thus, the difference is calculated between the additional costs (as NPV) for the 'Best' estimate scenario and the scenario in which one parameter is changed to the corresponding parameter in the 'Low' or 'High' estimate scenario.

ANNEX XV RESTRICTION REPORT – PFAS IN FIREFIGHTING FOAMS

Table 17: Sensitivity analysis of costs (net present values) for RO2 (ban on the placing on the market, with low, best and high estimates) with RMM.

	Low scenario			Central scenario (best estimates)		High scenario		
	Low value used	Resulting total costs for RO1 all sectors together over the assessment period (€)	Difference to central scenario	Value used	Resulting total costs for RO1 all sectors together over the assessment period (€)	High value used	Resulting total costs for RO1 all sectors together over the assessment period (€)	Difference to central scenario
Parameters having an effect on emissions and potentially also on costs	Low emission value			Central value		High emission value		
PFAS concentration in foam concentrate (%)	2.00%	6 771 408 265	0	2.5%	6 771 408 265	3.00%	6 771 408 265	0
annual sales (t/y)	14 000	6 588 629 090	-182 779 175	18 000	6 771 408 265	20 000	6 862 797 852	91 389 587
annual usage rate stock incidents	13.00%	6 678 315 448	-93 092 817	10%	6 771 408 265	5.00%	7 098 300 044	326 891 779
annual usage rate stock training and testing	5.00%	6 697 557 986	-73 850 279	2.00%	6 771 408 265	1.00%	6 802 359 440	30 951 175
leakage during storage	0.50%	6 776 387 771	4 979 507	1.0%	6 771 408 265	2.00%	6 761 449 251	-9 959 014
emission formulation to WWT	1.00%	6 771 408 265	0	2%	6 771 408 265	2.00%	6 771 408 265	0
emission formulation to air	1.25%	6 771 408 265	0	2.50%	6 771 408 265	2.50%	6 771 408 265	0
emission formulation to soil	0.005%	6 771 408 265	0	0.010%	6 771 408 265	0.01%	6 771 408 265	0
Effectiveness of WWTP for PFASs	5.00%	6 771 408 265	0	0%	6 771 408 265	0.00%	6 771 408 265	0
Efficacy of bunding / control measures for incidents military (%)	97.00%	6 773 704 461	2 296 197	50%	6 771 408 265	0.00%	6 768 965 502	- 2 442 762

ANNEX XV RESTRICTION REPORT – PFAS IN FIREFIGHTING FOAMS

Efficacy of bunding / control measures for incidents civil aviation (%)	97.00%	6 772 761 622	1 353 358	50%	6 771 408 265	0.00%	6 769 968 523	-1 439 742
Parameters having an effect on costs only								
Incineration/disposal costs per liter of foam (not relevant for RO1)	900 €/ tonne	6 760 038 420	-11 369 844	1 000 €/tonne	6 771 408 265	1 250 €/ tonne	6 799 832 876	28 424 611
Average price €/tonne of PFAS-based foam	3 750 €/tonne	6 574 423 346	-196 984 919	3 000 €/tonne	6 771 408 265	2 700 €/tonne	6 850 202 232	78 793 968
Average price €/tonne of fluorine-free foam	2 700 €/tonne	6 627 635 164	-143 773 101	3 000 €/tonne	6 771 408 265	3 750 €/tonne	7 130 841 018	359 432 753
Additional volumes required % increase over PFAS based foams	+25% required	6 531 786 429	-239 621 835	+50% required	6 771 408 265	+75% required	7 011 030 100	239 621 835
Savings from avoided clean-up	Gradually increasing to €20 million per year	6 649 419 950	-121 988 315	Gradually increasing to €10 million per year	6 771 408 265	Gradually increasing to €5million per year	6 832 402 422	60 994 157
Cleaning costs per site (number of sites per sectors is not varied)	-50% in total cleaning costs	5 510 780 420	-1 260 627 844	Sector-specific, see Section 3 of the Annex XV report	6 771 408 265	+100% in total cleaning costs	9 292 663 953	2 521 255 689
Cleaning costs per site to achieve a threshold of 1 ppb (considered to be 10 times higher than for a threshold of 1 ppm)				Sector-specific, see Table 14	6 771 408 265	+900% in total cleaning costs	29 462 709 464	22 691 301 199
Cost of technical change per site	-50% for all sectors	4 996 590 962	-1 774 817 302	Sector-specific, see Section 3 of the Annex XV report	6 771 408 265	+200% for all sectors	13 870 677 474	7 099 269 209
Costs of technical means to contain releases and disposal of PFAS-contaminated water from	-50%	6 741 900 011	-29 508 254	€ 1/liter of foam	6 771 408 265	+100%	6 830 424 772	59 016 507

ANNEX XV RESTRICTION REPORT – PFAS IN FIREFIGHTING FOAMS

the fire-water run-off from testing/training and incidents								
--	--	--	--	--	--	--	--	--

Blue cells: reduction in costs; red cells: increase in costs; grey cells: no change in costs; yellow cells: best estimate for comparison

The sensitivity analysis shows similar results as for RO1. One difference to RO1 is that a higher annual usage rate of the stock, both for incidence and for training and testing, now leads to a reduction in costs, and vice versa. The percentage PFAS concentration in foam concentrate does not have an effect on costs, since costs are related to foam quantities but not the share of PFAS contained. The same holds for emission formulation factors to WWT, air and soil and effectiveness of WWTP for PFASs – these parameters do not have a consequence on the costs.

The highest influence on costs (due to high uncertainty) is due to the (sector-specific) costs of technical change per site (decrease by 26% and increase by 105%). Also the (sector-specific) cleaning costs per site have a rather high effect on the overall costs (decrease by 19% and increase by 37%).

From this sensitivity analysis, it can be concluded that adjusting cost factors has in most cases (apart from the technical changes and the cleaning costs which are specific to the sectors) only a small effect on the incremental costs (-3.5% up to 5.3%). The cost reduction of 3.5% pertains to a reduction of the percentage of additional volumes of fluorine-free foams required over PFAS-based foams (+25% instead of +50%), the increase of 5.3% pertains to an increase of the average price per ton of fluorine-free foam from 3 000 €/tonne to 3 750 €/tonne. The reduction of the annual usage rate of stock for incidents from 10% to 5% also leads to a relatively high increase of costs (4.8%).

Time profile of costs

The time profile of the different cost categories over 30 years is shown in Figure 40.

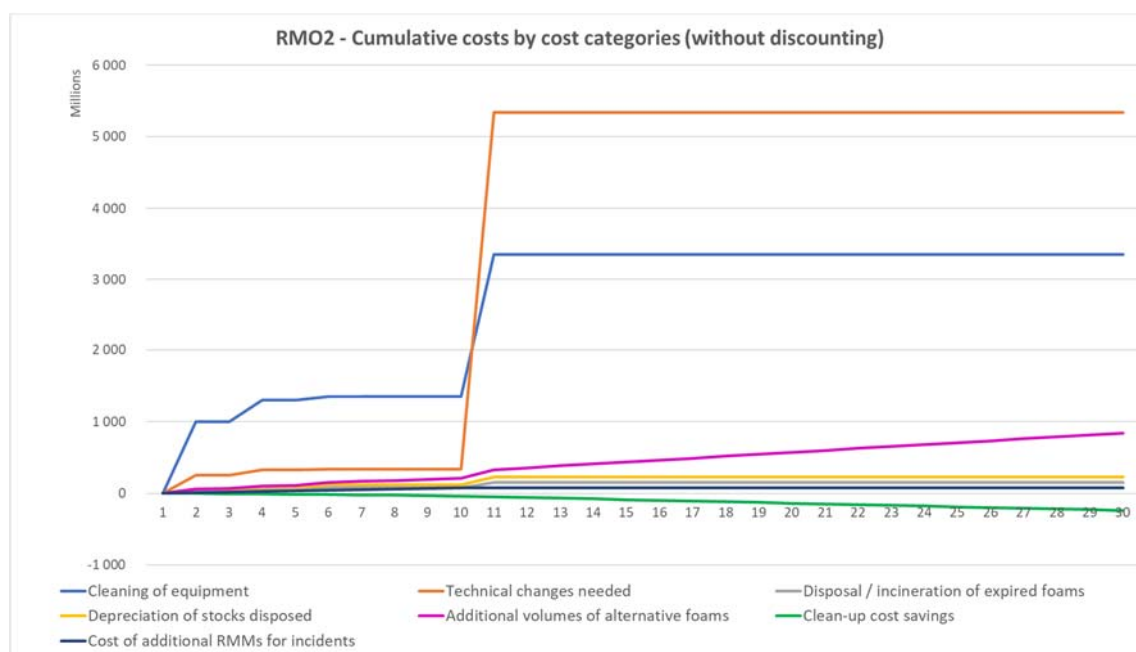

Figure 40: Cumulative costs of each cost category for scenario RO2 (all sectors, “Best” estimate scenario, without discounting).

The difference to the time profiles in RO1 mainly affects the cleaning costs, which are assumed to take place in the year following the end of the respective transition period, and are not spread over the following years. The main contribution of these cleaning costs

(and also on costs due to technical changes) stems from the Seveso sector and takes place in year 11. Additional volumes for alternative foams increase linearly after year 11, when the last transition periods for the sector of chemical/ petrochemical industry (Seveso) has ended, i.e. additional costs remain constant for each year. The same holds for the cost savings due to avoided clean-up.

9.3. RO3: same as RO2 but considering ban on exports

RO3 analyses the impacts of a ban of the export after a transitional period of ten years.

As explained in section 8.7.4, the emission estimates for RO3 in Appendix 8 are initially presented for a scenario with *continued export* beyond the sector-specific transitional periods. The figures obtained can be used to derive the contribution of the formulation for export to the cumulative PFAS emissions and therefore the impact of an *export ban* in RO3.

In this section, the figures are presented to directly describe the impacts of a *ban on export*, without the initial derivation from the opposite scenario.

Sensitivity analysis

For RO3, a sensitivity analysis can be performed in the same way as for RO1 and RO2. However, the results are not expected to be fundamentally different from those in RO2. Therefore, only the sensitivities for those parameters affecting the exports are discussed. These are the tonnage of exports and the number of years during which export-related profits are affected by the ban.

The annual sales are of interest because they are a parameter for the sensitivity of emission calculations. On the other hand, they also have a direct effect on the estimate of lost profits, because exports are assumed as 25% of total sales, i.e. the export revenues. Therefore, also the export-related profits vary with annual sales. When the sensitivity results of annual sales in RO3 are compared with those of RO2, however, the differences are rather small and the direct effect is not even noticeable. This is because this direct effect on the exports is rather small.

The effect of the number of years during which export-related profits are assumed to be lost, which is recommended to be used as a proxy for the change of producer surplus for REACH restrictions and authorisations (ECHA, 2021), shows an effect that was expected. Considering profits for five years increases additional social costs by €16 million and considering profits for 1 year only reduces the costs by €4 million compared to profits over two years in the central estimate.

Compared to sensitivity results of other parameters in RO1 and RO2, the influence of sensitivities related to export profits on the total results is rather small.

9.4. RO 4: Ban on the placing on the market and use, with permit system for Seveso and defence sites

Sensitivity analysis

For RO4, a sensitivity analysis can be performed in the same way as for the other ROs – in the Excel spreadsheet the respective sections in the calculations are provided. However,

the results are known by RO1 and RO2 and not expected to be fundamentally different in RO4. The only additional input parameter – the number of years with continued, but linearly decreasing use and formulation for the Seveso and defence sectors – is set as 20 years. It is in principle possible to vary this input parameter as well, however, it was not done as the restriction option is not considered practical. Therefore, RO4 includes no additional parameters for an explicit sensitivity analysis.

Time profile of costs

The time profile of the different cost categories over 30 years is shown in Figure 41.

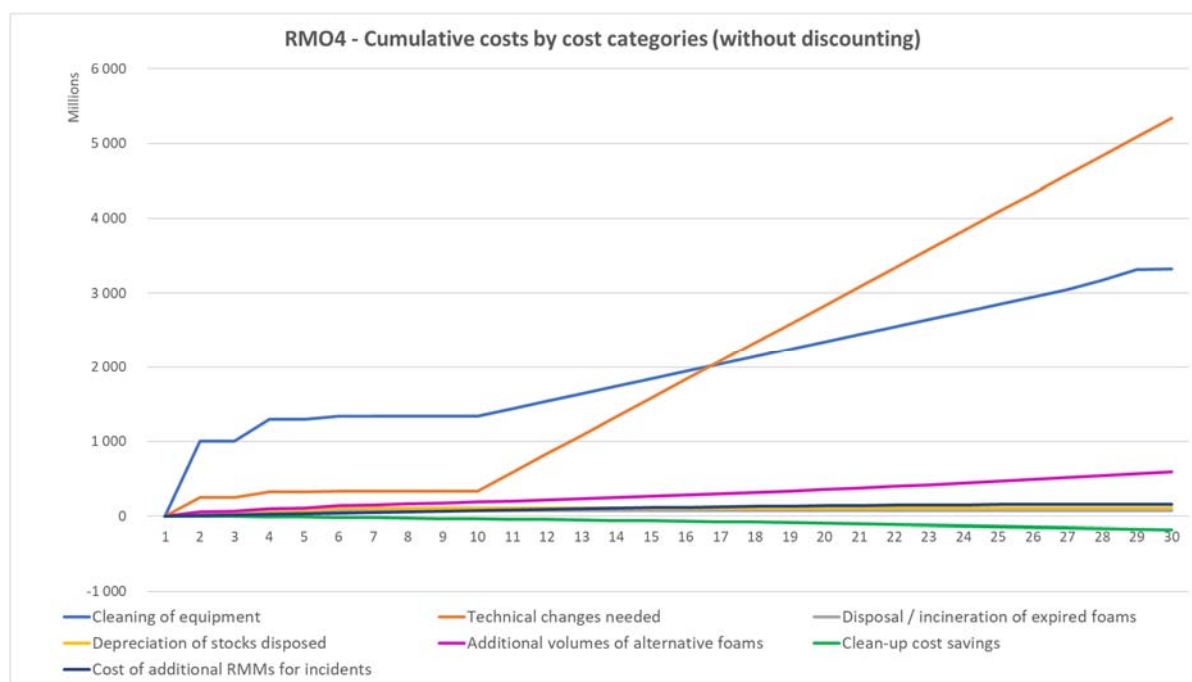

Figure 41: Cumulative costs of each cost category for scenario RO4 (all sectors, “Best” estimate scenario, without discounting).

The graph of Figure 41 shows that the technical changes needed and the cleaning costs (of which the Seveso sector has the largest share) are evenly spread over the years 11 to 30, because PFAS-based foams are gradually replaced by fluorine-free foams over these years. Although by the end of the time frame the cumulated (non-discounted) costs reach about the same level as in RO2, discounting by a rate of 4% results in a much lower NPV because in RO2 all cleaning costs and costs due to technical changes take place in year 11, immediately after the end of the transition period.

9.5. RO 5: Ban on the placing on the market and use, unless full containment in place

Sensitivity analysis

As the tendencies of the sensitivity analysis is already known for the input parameters to be varied, for RO5 only the additional parameter is examined that constitutes the difference to RO2 – the costs per site for RMMs to meet full containment. This is shown in Table 18.

ANNEX XV RESTRICTION REPORT – PFAS IN FIREFIGHTING FOAMS

Table 18: Sensitivity analysis of costs (net present values) for RO5 (ban on the placing on the market, with low, best and high estimates) with RMM.

	Low scenario			Central scenario (best estimates)		High scenario		
	Low value used	Resulting total costs for RO1 all sectors together over the assessment period (€)	Difference to central scenario	Value used	Resulting total costs for RO1 all sectors together over the assessment period (€)	High value used	Resulting total costs for RO1 all sectors together over the assessment period (€)	Difference to central scenario
Parameter having an effect on costs only								
Costs per site for RMMs to meet full containment (Seveso sector only)	-50%	8 467 481 646	-6 495 809 316	€2 000 000 per site	14 963 290 962	200%	40 946 528 224	25 983 237 263

The parameter of costs per site for RMMs to meet full containment is attached to a high degree of uncertainty and may strongly depend on the type of plant and firefighting system. A reduction of the parameter by 50%, i.e. a decrease from €2 million to €1 million leads to a decrease of total costs by 43%, an increase of the parameter by 200% (i.e. from €2 million to €6 million, causes an increase of total costs by 174%. This already leads to the conclusion that the costs of such a measure are clearly the dominating costs of this restriction option. These calculations are presented as illustrative, as full containment is not considered practically possible by the Dossier Submitter.

Time profile

In the time profile of the different cost categories over 30 years (Figure 42), all other cost categories (apart from RMMs to meet full containment and costs for cleaning of equipment) are close to the x-axis. It is assumed that implementation of RMMs to meet full containment has to take place in year 11 after the end of the transition period for the Seveso sector.

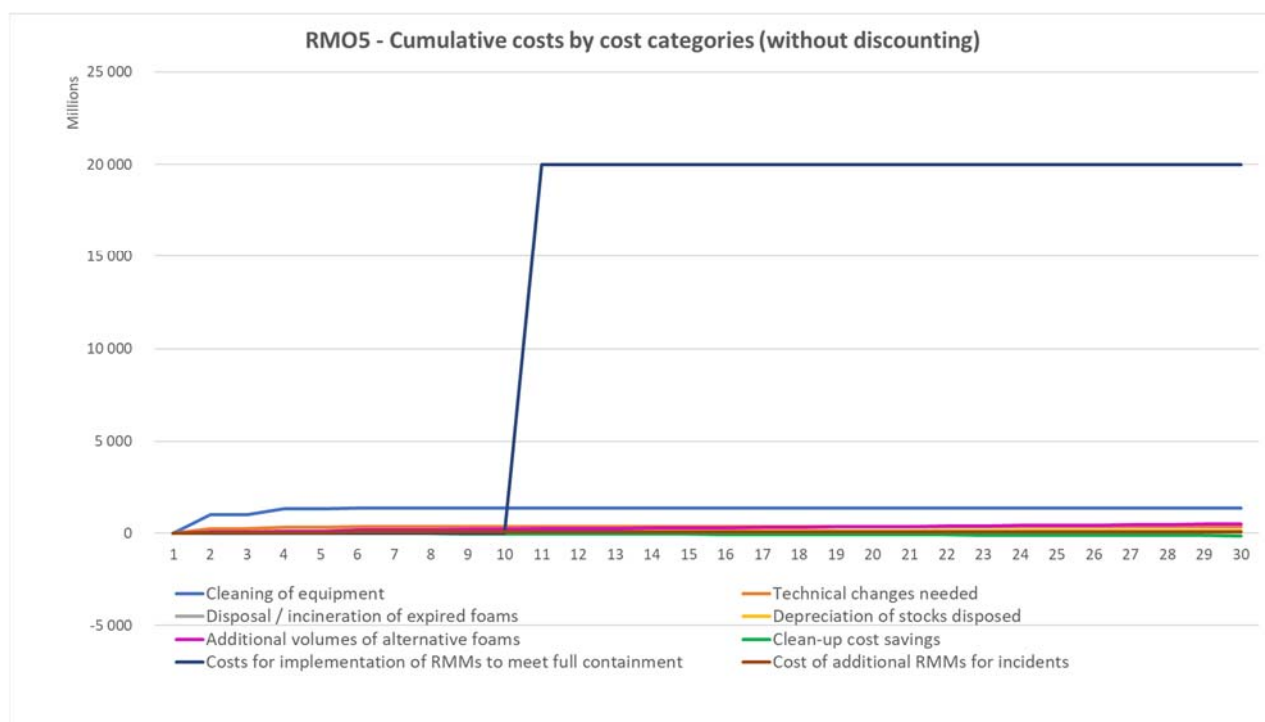

Figure 42: Cumulative costs of each cost category for scenario R05 (all sectors, “Best” estimate scenario, without discounting).

Appendix 10. Measured levels in environmental compartments

10.1. Introduction

As discussed in section 1.3 of the main report, only a small increment of PFASs have been so far monitored with targeted analytical methods. Consequently, a large number of substances that are classified as PFASs are never monitored for in environmental studies. Meanwhile, recent advancement of non-target and suspect screening methods using high-resolution mass spectrometry have enabled the semi-quantitative identification of many unknown substances in mainly abiotic environmental and product samples. These methods have led to the identification of emerging anionic, zwitterionic, cationic, and neutral PFASs in water (Strynar et al., 2015, Gebbink et al., 2016a), sediment (Newton et al., 2017), soil (Lin et al., 2017), airborne particulate matter (Yu et al., 2018), and biological samples (Liu et al., 2018a, De Silva et al., 2021). By now there is a wealth of information on the environmental occurrence available published as peer-reviewed articles and as research and project reports.

The aim of this section is not to provide an exhaustive review of all monitoring information available. Instead, rather selected key studies and results from monitoring programmes, primarily from the NORMAN network substantiating the properties described under section 1.1.4 and in the respective Annexes (B.4.1-B.4.4).

Searches for primary research studies and monitoring programs reporting on occurrence, levels and accumulation in different environmental samples and food webs from all compartments were conducted. Occurrence and concertation of all PFAS data available in the NORMAN database (11/2021) were extracted and analysed as well.

It is noted that for the presented monitoring data no differentiation has been made between the potential sources of PFASs, except where specified. Use of PFASs in firefighting foams is only one of the sources for the levels observed in the environment generally.

10.2. Distribution and mobility in water and soil

The basis for the following paragraphs on the occurrence of PFASs in water are the recent published review papers by Sims and coworkers (Sims et al., 2021). The main findings from this review paper are summarized according to the different matrixes (Groundwater, freshwater and marine water). The review examined 371 peer-reviewed studies published since 2001 to understand the occurrence and distribution of 24 priority PFASs in global surface waters and groundwater.

The occurrence of PFASs in soil and their distribution is discussed on the basis of a review paper (Brusseu et al., 2020) which aggregated soil-survey reports which comprise samples collected from all continents, and from a large variety of locations in both urban and rural regions.

These findings were complemented by analysis results from databases on monitoring data (IPChem, NORMAN) and results from national monitoring programs as well as published data. Measured levels of PFASs in surface waters, ground water, drinking water and soil are presented in Table 19, Table 20, Table 21 and Table 22

It has to be noted that the mentioned above review studies have either focused their literature research on a list of certain PFASs or data from literature itself mainly focusses on very few PFASs. Studies published between 2009 and 2017 have discovered 455 new PFASs (including nine fully and 446 partially fluorinated compounds), 45%, 29%, 17%, and 8% of which are anions, zwitterions, cations, and neutrals, respectively. They have been identified in natural waters, fish, sediments, wastewater, activated sludge, soils, aqueous film-forming foams, and commercial fluoropolymer surfactants (Xiao, 2017).

10.2.1. Occurrence of PFASs in Groundwater, freshwater and marine water

Tables presenting the levels of measured PFASs in surface water and ground water are at the bottom of this section (Tables Table 19 and Table 20).

Major sources of PFASs to the aquatic environment includes industrial runoff, wastewater treatment plants (WWTPs), landfills, atmospheric deposition, and AFFF storage and use in both training exercises and actual fire emergencies. Much of the contamination emerging from WWTP discharges originates from consumer products used within the household, which can release these compounds to wastewater collection systems during washing after usage (Xiao, 2017). As discussed in Annex B.4.5 conventional wastewater treatments have been shown to be ineffective as removal processes for many PFASs. The authors of the review point out that AFFF use is one of the leading contributors to surface waters and groundwater contamination in the environment, primarily near areas where the use and practice of removing foams can result in seepage to aquifers and introduction to watersheds near airports and air bases, where AFFF usage is highest (D'Agostino and Mabury, 2017; Moody and Field, 1999, 2000).

Literature was reviewed focussing with the aim to identify global distributions of 24 PFASs. They include: C4-C14 PFCA, C4-C10 PFSA perfluorooctane sulfonamide (PFOSA), 4:2 fluorotelomer sulfonate (4:2 FTSA), 6:2 fluorotelomer sulfonate (6:2 FTSA), 8:2 fluorotelomer sulfonate (8:2 FTSA), 2-(N-methylperfluorooctane sulfonamido) acetic acid (N-MeFOSAA), and 2-(N-ethylperfluorooctanesulfonamido) acetic acid (N-EtFOSAA in both surface waters and groundwater), between 2001 and 2020 from all searches. Of these results, 3313 paper were identified as relevant to the review based on the inclusion criteria of identifying occurrence information from aquatic systems and groundwaters. Since 2001, 371 unique papers were identified in the literature search, a majority of which investigated surface waters (349) with much fewer examining groundwater occurrence (65). Globally, Asia (207) had the largest number of publications regarding PFASs water distribution, followed by Europe (106) and North America (66). Other regions, including Oceania (11), Africa (10), Antarctica (5), South America (1), the Middle East (1) and the open oceans (7), had much less data regarding PFASs contamination of environmental waters. Inland waters have received more attention than coastal and marine systems likely because sources of PFASs contamination have been reported to result from military or firefighting training grounds, industrial processes, or discharges from wastewater treatment plants to receiving systems, and eventually to groundwater. The most commonly studied aquatic systems, and in most cases, were the most contaminated. This contamination gradient from inland lotic to lentic systems, and then lowest values in coastlines and oceans was observed. This pattern fits to the list of potential sources for water contamination with PFASs allowing to gradually dilute from rivers to coast water to oceans with water as a mobile matrix to distribute PFASs worldwide.

Detection frequencies ranged between 90% for PFOA and 81% for PFOS 80% for PFHxA down to 15% N-MeFOSAA in surface water. In groundwater detection frequencies ranged between 68% (PFHxA) to 1% for N-MeFOSAA. Trends in detection-frequencies do not necessarily reflect the distribution properties of the investigated PFASs as their use pattern also plays a role. (Groundwater measured levels make here an exception showing some chain length dependent trend).

It is important to note that >C9 PFCAs and PFASs were generally detected at lower concentrations compared to the shorter-chain homologues in both surface waters and groundwater. For example, the occurrence of PFASs in groundwater and surface water at the Maozhou River basin in China indicates that the detection frequencies of C4–C8 chains (C4–C8) PFASs were higher than C9–C14 chains PFASs in the river and groundwater. Statistical analysis showed an obvious correlation between the major contaminants in the river and those in the groundwater, indicating the potential linkage of PFASs in the groundwater to the surface water (Li et al., 2020). In many cases, these longer chain compounds were not produced intentionally and are only present as impurities and precursors in many products; however, the voluntary phase-out of long-chain PFASs in industrial facilities and consumer products, and replacement with shorter chain analogues may have also played a role in their occurrence (Cousins et al., 2019). Physico-chemical properties of these long-chain PFASs and environmental partitioning dynamics clearly will also affect their fate in the environment. In this context it has to be noted that ultra-short-chain PFASs are often lacking in monitoring programs as they are analytically challenging (Björnsdotter et al., 2020). For instance in one work (Janda et al., 2019) TFA revealed a more ubiquitous occurrence and was found in concentrations between 0.045 and 17 µg/L in drinking water, groundwater and surface water.

Monitoring data from groundwater available from the databases IPCHEM and NORMAN are available from Sweden, Italy, France and Austria from several locations. In European groundwaters, the levels of individual short-chain PFASs have been measured up to several micrograms per litre (see Table Table 19). Groundwater concentrations range between <LOQ and 1280 ng/L for PFBA, <LOQ and 902 ng/L for PFPeA, <LOQ and 1890 ng/L for PFHxA. Concentrations of PFOS and PFOA were the highest out of the long-chain PFASs in European groundwaters (between <LOQ and 42 200 ng/L for PFOS; between <LOQ and 29 886 ng/L for PFOA). Also high PFHxS and 6:2FtS concentrations have been measured in Sweden (up to 3470 ng/L for PFHxS and 2680 ng/L for 6:2FtS) and France (up to 2860 ng/L for PFHxS).

Results from groundwater monitoring near point sources indicate that PFAS concentrations in groundwater and aquifers are highly variable even within a few kilometers, at least based on the currently available information, which inherently is influenced by site-specific geological factors. Thus, point-source contamination may be challenging to identify unless locations of use or production has been identified or is suspected in an area. For example, levels of PFOA around the facility were on average around 15,000 ng/L, however, when compared to observations only 1–4 km away, mean PFOA dropped to 23 ng/L, and then further decreased to 2.6 ng/L when sampled 4–10 km away from the facility (Liu et al., 2016). A similar gradient was seen by Filipovic et al. in Stockholm, Sweden for groundwater contamination by AFFF at a former air force base. Concentrations of PFOS in some wells reached 42,200 ng/L while others within a few kilometers were as low as 7 ng/L (Filipovic et al., 2015).

Table 19. Collection* of PFAS levels of PFASs detected in groundwater.

ANNEX XV RESTRICTION REPORT – PFAS IN FIREFIGHTING FOAMS

PFASs	CAS	Country	Matrix	Unit	Min	Max	Number of studies
PFOA	335-67-1	Austria	ground water	ng/L	<1	13.7	3
PFOS	1763-23-1	Austria	ground water	ng/L	<1	37.3	3
6:2FtS	27619-97-2	France	ground water	ng/L	<4	150	3
8:2FtS	39108-34-4	France	ground water	ng/L	<4	9	2
PFBA	375-22-4	France	ground water	ng/L	<LO Q	327	5
PFBS	375-73-5	France	ground water	ng/L	<LO Q	750	5
PFDA	335-76-2	France	ground water	ng/L	<LO Q	5	5
PFDaA	307-55-1	France	ground water	ng/L	0.58	29	3
PFDS	335-77-3	France	ground water	ng/L		0.06	3
PFHpA	375-85-9	France	ground water	ng/L	<LO Q	224	6
PFHpS	375-92-8	France	ground water	ng/L	<4	204	4
PFHxA	307-24-4	France	ground water	ng/L	<LO Q	1340	5
PFHxS	355-46-4	France	ground water	ng/L	<LO Q	2860	5
PFNA	375-95-1	France	ground water	ng/L	<LO Q	14	6
PFOA	335-67-1	France	ground water	ng/L	<LO Q	341	6
PFOS	1763-23-1	France	ground water	ng/L	<LO Q	581	4
PFOSA	754-91-6	France	ground water	ng/L	0.17	1	3
PFPeA	2706-90-3	France	ground water	ng/L	<LO Q	902	5
PFTTrDA	72629-94-8	France	ground water	ng/L		<10	3
PFUdA	2058-94-8	France	ground water	ng/L		0.05	3
PFBA	375-22-4	Germany	ground water	ng/L	90	280	1
PFHpA	375-85-9	Germany	ground water	ng/L	300	560	1
PFHxA	307-24-4	Germany	ground water	ng/L	250	770	1
PFOA	335-67-1	Germany	ground water	ng/L	440	1700	1

ANNEX XV RESTRICTION REPORT – PFAS IN FIREFIGHTING FOAMS

PFPeA	2706-90-3	Germany	ground water	ng/L	290	830	1
PFPrA Perfluoropropanoic acid	422-64-0	Germany	ground water	ng/L	56	100	1
TFA	76-05-1	Germany	ground water	ng/L	830	2200	1
PFBS	375-73-5	Ireland	ground water	ng/L	0.08	0.22	1
PFHxS	355-46-4	Ireland	ground water	ng/L	0.12	0.28	1
PFNA	375-95-1	Ireland	ground water	ng/L		0.22	1
PFOA	335-67-1	Ireland	ground water	ng/L	1.6	140	1
PFOS	1763-23-1	Ireland	ground water	ng/L	0.32	1.34	1
PFOSA	754-91-6	Ireland	ground water	ng/L	0.1	0.38	1
PFBS	375-73-5	Italy	ground water	ng/L	1	29	2
PFBA	375-22-4	Italy	ground water	ng/L	6.3	125	2
PFDA	335-76-2	Italy	ground water	ng/L	0.5	34	2
PFDoA	307-55-1	Italy	ground water	ng/L	1	13	2
PFHpA	375-85-9	Italy	ground water	ng/L	0.88	761	2
PFHxS	355-46-4	Italy	ground water	ng/L	5.3	125	2
PFHxA	307-24-4	Italy	ground water	ng/L	0.7	840	2
PFNA	375-95-1	Italy	ground water	ng/L	0.5	34.22	2
PFOA	335-67-1	Italy	ground water	ng/L	1.4	29886	3
PFOS	1763-23-1	Italy	ground water	ng/L	1.9	234	3
PFPeA	2706-90-3	Italy	ground water	ng/L	2	62	2
PFUdA	2058-94-8	Italy	ground water	ng/L	0.5	9	2
PFHpA	375-85-9	Malta	ground water	ng/L	<LOD	1.36	1
PFHxA	307-24-4	Malta	ground water	ng/L	<LOD	1.95	1
PFHxS	355-46-4	Malta	ground water	ng/L	<LOD	2.22	1
PFNA	375-95-1	Malta	ground water	ng/L		0.9	1

ANNEX XV RESTRICTION REPORT – PFAS IN FIREFIGHTING FOAMS

PFOA	335-67-1	Malta	ground water	ng/L	<LOD	2.68	1
PFOS	1763-23-1	Malta	ground water	ng/L	<LOD	2.09	1
PFBA	375-22-4	Netherlands	ground water	ng/L	1.3	1280	1
PFBS	375-73-5	Netherlands	ground water	ng/L	<LOQ	104	1
PFHpA	375-85-9	Netherlands	ground water	ng/L	<LOQ	318	1
PFHxA	307-24-4	Netherlands	ground water	ng/L	0.22	670	1
PFHxS	355-46-4	Netherlands	ground water	ng/L	<LOQ	107	1
PFNA	375-95-1	Netherlands	ground water	ng/L	<LOQ	0.2	1
PFOA	335-67-1	Netherlands	ground water	ng/L	<LOQ	2060	1
PFOS	1763-23-1	Sweden	ground water	ng/L	<LOD	42200	3
PFUdA	2058-94-8	Sweden	ground water	ng/L	<LOD	20	3
N-MeFOSAA	2355-31-9	Sweden	ground water	ng/L	<MDL	8.3	1
PFPeA	2706-90-3	Sweden	ground water	ng/L	<LOD	19	3
PFPeS	2706-91-4	Sweden	ground water	ng/L	<LOD	9.4	1
6:2FtS	27619-97-2	Sweden	ground water	ng/L	<LOD	2680	2
N-EtFOSAA	2991-50-6	Sweden	ground water	ng/L	<MDL	8	1
PFHxA	307-24-4	Sweden	ground water	ng/L	<LOD	1890	4
PFDoA	307-55-1	Sweden	ground water	ng/L	<LOD	59	3
PFOA	335-67-1	Sweden	ground water	ng/L	<LOD	4470	4
PFDA	335-76-2	Sweden	ground water	ng/L	<LOD	113	3
PFDS	335-77-3	Sweden	ground water	ng/L	<LOD	5.1	2
PFHxS	355-46-4	Sweden	ground water	ng/L	<LOD	3470	3
PFBA	375-22-4	Sweden	ground water	ng/L	<LOD	409	3
PFBS	375-73-5	Sweden	ground water	ng/L	<LOD	22	3
PFHpA	375-85-9	Sweden	ground water	ng/L	<LOD	740	3

ANNEX XV RESTRICTION REPORT – PFAS IN FIREFIGHTING FOAMS

PFHpS	375-92-8	Sweden	ground water	ng/L	<LOD	39	1
PFNA	375-95-1	Sweden	ground water	ng/L	<LOD	66	3
PFTeDA	376-06-7	Sweden	ground water	ng/L	<LOD	4.9	3
PFNS	68259-12-1	Sweden	ground water	ng/L	<LOD	18	1
PFTTrDA	72629-94-8	Sweden	ground water	ng/L	<LOD	4.1	2
PFOSA	754-91-6	Sweden	ground water	ng/L	<MD L	9	2

* the presented data originates from: (Barreca et al., 2018, Björnsdotter et al., 2020) (Boiteux et al., 2016) (Boiteux et al., 2012, Brueller et al., 2018, Dauchy et al., 2017b, Eschauzier et al., 2013b, Filipovic et al., 2014, Gao et al., 2019, Gobelius et al., 2018, Harrad et al., 2020, Janda et al., 2019, Mazzoni et al., 2015, Munoz et al., 2017b, Pignotti et al., 2017, Sammut et al., 2019, Zoboli et al., 2019, Dauchy et al., 2018)

Table 20. Collection of the levels detected in surface waters.

PFASs	CAS	Unit	Country	Matrix	Min	Max	Number of studies/ Data owner
Perfluorooctanesulfonic acid (PFOS)	1763-23-1	µg/l	Austria	Surface water - River water	0	0.0110	2
Perfluorohexanoic acid (PFHxA)	307-24-4	µg/l	Austria	Surface water - River water	0	0.0079	2
Perfluorooctanoic acid (PFOA)	335-67-1	µg/l	Austria	Surface water - River water	0	0.0400	2
Perfluorodecanoic acid (PFDA)	335-76-2	µg/l	Austria	Surface water - River water	0	0.0009	2
Perfluorobutanesulfonic acid (PFBS)	375-73-5	µg/l	Austria	Surface water - River water	0	0.0030	2
Perfluoroheptanoic acid (PFHpA)	375-85-9	µg/l	Austria	Surface water - River water	0	0.0066	2
Perfluorononanoic acid (PFNA)	375-95-1	µg/l	Austria	Surface water - River water	0	0.0025	2
Perfluorooctanesulfonate	4529-8-90-6	µg/l	Austria	Surface water - River water	0.0065	0.0157	1
PFOS	1763-23-1	µg/l	Austria	surface water (filtered)	<LOQ	0.0110	1
PFOA	335-67-1	µg/l	Austria	surface water (filtered)	< LOQ	0.0064	1
Perfluorooctanesulfonic acid (PFOS)	1763-23-1	µg/l	Bulgaria	Surface water - River water	0	0.0080	2
Perfluorohexanoic acid (PFHxA)	307-24-4	µg/l	Bulgaria	Surface water - River water	0	0.0038	3
Perfluorooctanoic acid (PFOA)	335-67-1	µg/l	Bulgaria	Surface water - River water	0	0.0135	3

ANNEX XV RESTRICTION REPORT – PFAS IN FIREFIGHTING FOAMS

Perfluorobutane sulfonic acid (PFBS)	375-73-5	µg/l	Bulgaria	Surface water - River water	0	0.0020	2
Perfluoroheptanoic acid (PFHpA)	375-85-9	µg/l	Bulgaria	Surface water - River water	0	0.0012	3
Perfluorononanoic acid (PFNA)	375-95-1	µg/l	Bulgaria	Surface water - River water	0	0.0017	2
Perfluorooctanesulfonate	4529-8-90-6	µg/l	Bulgaria	Surface water - River water	0	0.0574	1
Perfluorooctanesulfonic acid (PFOS)	1763-23-1	µg/l	Croatia	Surface water - River water	0	0.0082	2
Perfluorohexanoic acid (PFHxA)	307-24-4	µg/l	Croatia	Surface water - River water	0	0.0059	3
Perfluorooctanoic acid (PFOA)	335-67-1	µg/l	Croatia	Surface water - River water	0	0.0300	4
Perfluorobutane sulfonic acid (PFBS)	375-73-5	µg/l	Croatia	Surface water - River water	0	0.0030	2
Perfluoroheptanoic acid (PFHpA)	375-85-9	µg/l	Croatia	Surface water - River water	0	0.0190	3
Perfluorononanoic acid (PFNA)	375-95-1	µg/l	Croatia	Surface water - River water	0	0.0013	2
Perfluorooctanesulfonate	4529-8-90-6	µg/l	Croatia	Surface water - River water	0.0051	0.0119	1
Perfluorooctanoic acid (PFOA)	335-67-1	µg/l	Czech Republic	Surface water - River water	0.0083	0.0097	1
Perfluorodecanoic acid (PFDA)	335-76-2	µg/l	Czech Republic	Surface water - River water	0	0.0010	1
Perfluoroheptanoic acid (PFHpA)	375-85-9	µg/l	Czech Republic	Surface water - River water	0.0020	0.0026	1
Perfluorononanoic acid (PFNA)	375-95-1	µg/l	Czech Republic	Surface water - River water	0.0017	0.0029	1
Perfluorooctanesulfonate	4529-8-90-6	µg/l	Czech Republic	Surface water - River water	0.0115	0.0203	1
Perfluorooctanesulfonic acid (PFOS)	1763-23-1	µg/l	France	Surface water - River water	0	1.9000	1
Perfluoroundecanoic acid (PFUdA)	2058-94-8	µg/l	France	Surface water - River water	0	0.0090	1
Perfluorohexanoic acid (PFHxA)	307-24-4	µg/l	France	Surface water - River water	0	0.3010	1
Perfluorooctanoic acid (PFOA)	335-67-1	µg/l	France	Surface water - River water	0	9.0000	1
Perfluorodecanoic acid (PFDA)	335-76-2	µg/l	France	Surface water - River water	0	0.0100	1

ANNEX XV RESTRICTION REPORT – PFAS IN FIREFIGHTING FOAMS

Perfluoroheptanoic acid (PFHpA)	375-85-9	µg/l	France	Surface water - River water	0	0.0070	1
Perfluorononanoic acid (PFNA)	375-95-1	µg/l	France	Surface water - River water	0	0.2260	1
Perfluorooctanesulfonamide (PFOSA)	754-91-6	µg/l	France	Surface water - River water	0	0.0070	1
acide sulfonique de perfluorooctane	1763-23-1	µg/L	France	Water (Surface Water)	0.001	17.1000	1
acide perfluorooctanoïque	2058-94-8	µg/L	France	Water (Surface Water)	0.001	0.5000	1
acide perfluoropentanoïque	2706-90-3	µg/L	France	Water (Surface Water)	0.05	1.0000	1
acide perfluorohexanoïque	307-24-4	µg/L	France	Water (Surface Water)	0.001	3.0500	1
acide perfluorododecanoïque	307-55-1	µg/L	France	Water (Surface Water)	0.001	0.5000	1
acide perfluorooctanoïque	335-67-1	µg/L	France	Water (Surface Water)	0.002	5.4500	1
acide perfluorodecanoïque	335-76-2	µg/L	France	Water (Surface Water)	0.001	0.5000	1
acide perfluorododecane sulfonique	335-77-3	µg/L	France	Water (Surface Water)	0.001	0.5000	1
perfluorohexane sulfonic acid	355-46-4	µg/L	France	Water (Surface Water)	0.001	0.4900	1
acide perfluorobutanoïque	375-22-4	µg/L	France	Water (Surface Water)	0.001	4.0000	1
acide perfluorohéptanoïque	375-85-9	µg/L	France	Water (Surface Water)	0.001	0.9000	1
acide perfluoroheptane sulfonique	375-92-8	µg/L	France	Water (Surface Water)	0.001	2.0000	1
acide perfluorononanoïque	375-95-1	µg/L	France	Water (Surface Water)	0.001	0.4000	1
acide perfluorotétracanoïque	376-06-7	µg/L	France	Water (Surface Water)	0.005	1.0000	1
sulfluramid	4151-50-2	µg/L	France	Water (Surface Water)	0.02	0.2500	1
sulfonate de perfluorooctane	4529-8-90-6	µg/L	France	Water (Surface Water)	0.001	9.5000	1
acide sulfonique de perfluorobutane	5993-3-66-3	µg/L	France	Water (Surface Water)	0.001	1.2000	1
acide pentacosafuorotridecanoïque	7262-9-94-8	µg/L	France	Water (Surface Water)	0.06	4.0000	1

ANNEX XV RESTRICTION REPORT – PFAS IN FIREFIGHTING FOAMS

perfluorooctanesulfonamide	754-91-6	µg/L	France	Water (Surface Water)	0.001	0.4000	1
Perfluorooctanesulfonic acid (PFOS)	1763-23-1	µg/l	Georgia	Surface water - Sea water	0	0.0000	2
Perfluorooctanoic acid (PFOA)	335-67-1	µg/l	Georgia	Surface water - Sea water	0	0.0015	2
Perfluorohexanesulfonic acid (PFHxS)	355-46-4	µg/l	Georgia	Surface water - Sea water	0	0.0005	2
Perfluorobutanesulfonic acid (PFBS)	375-73-5	µg/l	Georgia	Surface water - Sea water	0	0.0001	2
Perfluoroheptanoic acid (PFHpA)	375-85-9	µg/l	Georgia	Surface water - Sea water	0	0.0008	2
Perfluorononanoic acid (PFNA)	375-95-1	µg/l	Georgia	Surface water - Sea water	0	0.0006	2
Perfluorohexanesulfonate	1084-27-53-8	µg/l	German y	Surface water - Coastal water	0.0001 45	0.0002	1
Perfluorohexanoic acid (PFHxA)	307-24-4	µg/l	German y	Surface water - Coastal water	0.0000 96	0.0002	1
Perfluorooctanoic acid (PFOA)	335-67-1	µg/l	German y	Surface water - Coastal water	0.0004 71	0.0009	1
Perfluoroheptanoic acid (PFHpA)	375-85-9	µg/l	German y	Surface water - Coastal water	0.0001 48	0.0002	1
Perfluorooctanesulfonate	4529-8-90-6	µg/l	German y	Surface water - Coastal water	0.0003 28	0.0006	1
Perfluorooctanoic acid (PFOA)	335-67-1	µg/l	German y	Surface water - Lake water	0	0.0050	1
Perfluorooctanesulfonic acid (PFOS)	1763-23-1	µg/l	German y	Surface water - River water	0.0069	0.0230	1
Perfluorohexanoic acid (PFHxA)	307-24-4	µg/l	German y	Surface water - River water	0	0.0060	2
Perfluorooctanoic acid (PFOA)	335-67-1	µg/l	German y	Surface water - River water	0	3.0000	2
Perfluorodecanoic acid (PFDA)	335-76-2	µg/l	German y	Surface water - River water	0	0.0010	1
Perfluorohexanesulfonic acid (PFHxS)	355-46-4	µg/l	German y	Surface water - River water	0	0.0030	1
Perfluorobutanesulfonic acid (PFBS)	375-73-5	µg/l	German y	Surface water - River water	0	0.0023	2
Perfluoroheptanoic acid (PFHpA)	375-85-9	µg/l	German y	Surface water - River water	0	0.0026	2
Perfluorononanoic acid (PFNA)	375-95-1	µg/l	German y	Surface water - River water	0	0.0027	2

ANNEX XV RESTRICTION REPORT – PFAS IN FIREFIGHTING FOAMS

Perfluorooctanesulfonate	4529 8-90-6	µg/l	Germany	Surface water - River water	0.0019	0.0189	1
Perfluorooctanesulfonic acid (PFOS)	1763 -23-1	µg/l	Hungary	Surface water - River water	0	0.0260	2
Perfluorohexanoic acid (PFHxA)	307- 24-4	µg/l	Hungary	Surface water - River water	0	0.0300	3
Perfluorooctanoic acid (PFOA)	335- 67-1	µg/l	Hungary	Surface water - River water	0	0.0370	4
Perfluorodecanoic acid (PFDA)	335- 76-2	µg/l	Hungary	Surface water - River water	0	0.0008	2
Perfluorobutanesulfonic acid (PFBS)	375- 73-5	µg/l	Hungary	Surface water - River water	0	0.0037	2
Perfluoroheptanoic acid (PFHpA)	375- 85-9	µg/l	Hungary	Surface water - River water	0	0.0100	3
Perfluorononanoic acid (PFNA)	375- 95-1	µg/l	Hungary	Surface water - River water	0	0.0027	2
Perfluorooctanesulfonate	4529 8-90-6	µg/l	Hungary	Surface water - River water	0.0007	0.0114	1
Perfluorohexanesulfonate	1084 27- 53-8	µg/l	International Waters	Surface water - Coastal water	0.0000 04	0.0000	1
Perfluorohexanoic acid (PFHxA)	307- 24-4	µg/l	International Waters	Surface water - Coastal water	0.0000 08	0.0000	1
Perfluorooctanoic acid (PFOA)	335- 67-1	µg/l	International Waters	Surface water - Coastal water	0.0000 2	0.0005	1
Perfluoroheptanoic acid (PFHpA)	375- 85-9	µg/l	International Waters	Surface water - Coastal water	0.0000 08	0.0001	1
Perfluorooctanesulfonate	4529 8-90-6	µg/l	International Waters	Surface water - Coastal water	0.0000 05	0.0001	1
perfluorooctane sulfonate - pfos	1763 -23-1	ng/L	Italy	Surface Water	2	218.00 00	1
perfluoro-n-undecanoic acid - pfuna	2058 -94-8	ng/L	Italy	Surface Water	0.5	58.000 0	1
perfluoropentanoic acid - pfpea	2706 -90-3	ng/L	Italy	Surface Water	2	974.00 00	1
perfluorohexanoic acid - pfhxa	307- 24-4	ng/L	Italy	Surface Water	0.4	892.00 00	1
perfluorododecanoic acid - pfdoa	307- 55-1	ng/L	Italy	Surface Water	1	19.000 0	1
perfluorooctanoic acid - pfoa	335- 67-1	ng/L	Italy	Surface Water	0.6	6480.0 000	1

ANNEX XV RESTRICTION REPORT – PFAS IN FIREFIGHTING FOAMS

perfluorodecanoic acid - pfda	335-76-2	ng/L	Italy	Surface Water	0.5	99.0000	1
perfluorohexanesulfonate - pfhxs	355-46-4	ng/L	Italy	Surface Water	5.1	36.0000	1
perfluorobutanoic acid - pfba	375-22-4	ng/L	Italy	Surface Water	8.2	411.0000	1
perfluorobutanesulfonate - pfbs	375-73-5	ng/L	Italy	Surface Water	1	4328.0000	1
perfluoroheptanoic acid - pfhpa	375-85-9	ng/L	Italy	Surface Water	0.3	946.0000	1
perfluorononanoic acid - pfna	375-95-1	ng/L	Italy	Surface Water	0.5	174.0000	1
Perfluorooctanoic acid (PFOA)	335-67-1	µg/l	Italy	Surface water - Lake water	0	0.0030	2
Perfluoroheptanoic acid (PFHpA)	375-85-9	µg/l	Italy	Surface water - Lake water	0	0.0020	1
Perfluorononanoic acid (PFNA)	375-95-1	µg/l	Italy	Surface water - Lake water	0	0.0020	1
Perfluorooctanesulfonate	4529-8-90-6	µg/l	Italy	Surface water - Lake water	0	0.0240	2
Perfluoroundecanoic acid (PFUdA)	2058-94-8	µg/l	Italy	Surface water - River water	0	0.0820	2
Perfluorohexanoic acid (PFHxA)	307-24-4	µg/l	Italy	Surface water - River water	0	0.0350	1
Perfluorooctanoic acid (PFOA)	335-67-1	µg/l	Italy	Surface water - River water	0	1.4650	2
Perfluorodecanoic acid (PFDA)	335-76-2	µg/l	Italy	Surface water - River water	0	0.0040	1
Perfluoroheptanoic acid (PFHpA)	375-85-9	µg/l	Italy	Surface water - River water	0	0.0360	2
Perfluorononanoic acid (PFNA)	375-95-1	µg/l	Italy	Surface water - River water	0	0.1270	2
Perfluorooctanesulfonate	4529-8-90-6	µg/l	Italy	Surface water - River water	0	0.0380	2
perfluorooctanesulfonate - pfos	1763-23-1	ng/L	Italy	Transitional Water	3.7	5.0000	1
perfluoro-n-undecanoic acid - pfuna	2058-94-8	ng/L	Italy	Transitional Water	0.5	1.2000	1
perfluoropentanoic acid - pfpea	2706-90-3	ng/L	Italy	Transitional Water	2	8.0000	1
perfluorohexanoic acid - pfhxa	307-24-4	ng/L	Italy	Transitional Water	0.5	4.3000	1
perfluorododecanoic acid - pfdoa	307-55-1	ng/L	Italy	Transitional Water	1	2.9000	1
perfluorooctanoic acid - pfoa	335-67-1	ng/L	Italy	Transitional Water	0.6	19.4000	1

ANNEX XV RESTRICTION REPORT – PFAS IN FIREFIGHTING FOAMS

perfluorodecanoic acid - pfd	335-76-2	ng/L	Italy	Transitional Water	0.5	1.1000	1
perfluorohexanesulfonate - pfhs	355-46-4	ng/L	Italy	Transitional Water		10.0000	1
perfluorobutanoic acid - pfba	375-22-4	ng/L	Italy	Transitional Water	10	30.6000	1
perfluorobutanesulfonate - pfbs	375-73-5	ng/L	Italy	Transitional Water	0.9	9.9000	1
perfluoroheptanoic acid - pfhpa	375-85-9	ng/L	Italy	Transitional Water	0.8	2.5000	1
perfluorononanoic acid - pfna	375-95-1	ng/L	Italy	Transitional Water		0.5000	1
Perfluorohexanesulfonate	1084-27-53-8	µg/l	Netherlands	Surface water - River water	0	0.0090	1
Perfluoroundecanoic acid (PFUdA)	2058-94-8	µg/l	Netherlands	Surface water - River water	0	0.0010	1
Perfluoropentanoic acid (PFPeA)	2706-90-3	µg/l	Netherlands	Surface water - River water	0	0.0260	1
Perfluorohexanoic acid (PFHxA)	307-24-4	µg/l	Netherlands	Surface water - River water	0	0.0074	1
Perfluorooctanoic acid (PFOA)	335-67-1	µg/l	Netherlands	Surface water - River water	0	0.0300	1
Perfluorodecanoic acid (PFDA)	335-76-2	µg/l	Netherlands	Surface water - River water	0	0.0020	1
Perfluorobutanoic acid	375-22-4	µg/l	Netherlands	Surface water - River water	0	0.1200	1
Perfluoroheptanoic acid (PFHpA)	375-85-9	µg/l	Netherlands	Surface water - River water	0	0.0050	1
Perfluorononanoic acid (PFNA)	375-95-1	µg/l	Netherlands	Surface water - River water	0	0.0012	1
Perfluorooctanesulfonamide (PFOSA)	754-91-6	µg/l	Netherlands	Surface water - River water	0	0.0010	1
Perfluoropentanoic acid (PFPeA)	2706-90-3	µg/l	Netherlands	Surface water - Lake water	0	0.0063	1
Perfluorohexanoic acid (PFHxA)	307-24-4	µg/l	Netherlands	Surface water - Lake water	0	0.0049	1
Perfluorooctanoic acid (PFOA)	335-67-1	µg/l	Netherlands	Surface water - Lake water	0.001	0.0045	1
Perfluorodecanoic acid (PFDA)	335-76-2	µg/l	Netherlands	Surface water - Lake water	0	0.0004	1
Perfluorobutanoic acid	375-22-4	µg/l	Netherlands	Surface water - Lake water	0	0.0150	1
Perfluoroheptanoic acid (PFHpA)	375-85-9	µg/l	Netherlands	Surface water - Lake water	0	0.0025	1
Perfluorononanoic acid (PFNA)	375-95-1	µg/l	Netherlands	Surface water - Lake water	0	0.0005	1

ANNEX XV RESTRICTION REPORT – PFAS IN FIREFIGHTING FOAMS

Perfluorooctanesulfonic acid (PFOS)	1763-23-1	µg/l	Romani a	Surface water - River water	0	0.0069	2
Perfluorohexanoic acid (PFHxA)	307-24-4	µg/l	Romani a	Surface water - River water	0	0.0050	3
Perfluorooctanoic acid (PFOA)	335-67-1	µg/l	Romani a	Surface water - River water	0	0.0140	3
Perfluorobutane sulfonic acid (PFBS)	375-73-5	µg/l	Romani a	Surface water - River water	0	0.0020	2
Perfluoroheptanoic acid (PFHpA)	375-85-9	µg/l	Romani a	Surface water - River water	0	0.0013	3
Perfluorononanoic acid (PFNA)	375-95-1	µg/l	Romani a	Surface water - River water	0	0.0033	2
Perfluorooctanesulfonate	4529-8-90-6	µg/l	Romani a	Surface water - River water	0	0.1000	1
Perfluorooctanesulfonic acid (PFOS)	1763-23-1	µg/l	Serbia	Surface water - River water	0	0.0130	2
Perfluoroundecanoic acid (PFUdA)	2058-94-8	µg/l	Serbia	Surface water - River water	0	0.0100	1
Perfluorohexanoic acid (PFHxA)	307-24-4	µg/l	Serbia	Surface water - River water	0	0.0300	2
Perfluorooctanoic acid (PFOA)	335-67-1	µg/l	Serbia	Surface water - River water	0	0.0230	3
Perfluorobutanoic acid	375-22-4	µg/l	Serbia	Surface water - River water	0	0.0100	2
Perfluorobutane sulfonic acid (PFBS)	375-73-5	µg/l	Serbia	Surface water - River water	0	0.0030	2
Perfluoroheptanoic acid (PFHpA)	375-85-9	µg/l	Serbia	Surface water - River water	0	0.0079	3
Perfluorononanoic acid (PFNA)	375-95-1	µg/l	Serbia	Surface water - River water	0	0.1080	2
Perfluorooctanesulfonate	4529-8-90-6	µg/l	Serbia	Surface water - River water	0.0026 680261 522116 7	0.0087	1
Perfluorooctanesulfonic acid (PFOS)	1763-23-1	µg/l	Slovakia	Surface water - River water	0	0.0200	1
Perfluorohexanoic acid (PFHxA)	307-24-4	µg/l	Slovakia	Surface water - River water	0	0.0085	3
Perfluorooctanoic acid (PFOA)	335-67-1	µg/l	Slovakia	Surface water - River water		0.0525	2
Perfluorobutane sulfonic acid (PFBS)	375-73-5	µg/l	Slovakia	Surface water - River water	0	0.0021	2

ANNEX XV RESTRICTION REPORT – PFAS IN FIREFIGHTING FOAMS

Perfluoroheptanoic acid (PFHpA)	375-85-9	µg/l	Slovakia	Surface water - River water	0	0.0081	2
Perfluorononanoic acid (PFNA)	375-95-1	µg/l	Slovakia	Surface water - River water	0	0.0020	2
Perfluorooctanesulfonate	4529-8-90-6	µg/l	Slovakia	Surface water - River water	0.0040 491395 67314	0.0102	1
Perfluoroundecanoic acid (PFUdA)	2058-94-8	µg/l	Spain	Surface water - River water	0	0.0037	1
Perfluoropentanoic acid (PFPeA)	2706-90-3	µg/l	Spain	Surface water - River water	0	0.0678	1
Perfluorohexanoic acid (PFHxA)	307-24-4	µg/l	Spain	Surface water - River water	0	0.0310	1
Perfluorododecanoic acid (PFDoDA)	307-55-1	µg/l	Spain	Surface water - River water	0	0.0098	1
Perfluorooctanoic acid (PFOA)	335-67-1	µg/l	Spain	Surface water - River water	0	0.1880	1
Perfluorodecanoic acid (PFDA)	335-76-2	µg/l	Spain	Surface water - River water	0	0.2130	1
Perfluorobutanoic acid	375-22-4	µg/l	Spain	Surface water - River water	0	0.7430	1
Perfluoroheptanoic acid (PFHpA)	375-85-9	µg/l	Spain	Surface water - River water	0	0.0873	1
Perfluorononanoic acid (PFNA)	375-95-1	µg/l	Spain	Surface water - River water	0	0.1160	1
Perfluorotetradecanoic acid (PFTeDA)	376-06-7	µg/l	Spain	Surface water - River water	0	0.0175	1
Perfluoro-2-methyl-3-oxahexanoic acid	1325-2-13-6	µg/l	Ukraine	Surface water - Territorial (marine) water	0	0.0007	1
Perfluorooctanesulfonic acid (PFOS)	1763-23-1	µg/l	Ukraine	Surface water - Territorial (marine) water	0	0.0007	2
Perfluorohexanoic acid (PFHxA)	307-24-4	µg/l	Ukraine	Surface water - Territorial (marine) water	0	0.0006	2
Perfluorooctanoic acid (PFOA)	335-67-1	µg/l	Ukraine	Surface water - Territorial (marine) water	0	0.0027	2
Perfluorohexanesulfonic acid (PFHxS)	355-46-4	µg/l	Ukraine	Surface water - Territorial (marine) water	0	0.0016	2
Perfluorobutanesulfonic acid (PFBS)	375-73-5	µg/l	Ukraine	Surface water - Territorial (marine) water	0	0.0013	2
Perfluoroheptanoic acid (PFHpA)	375-85-9	µg/l	Ukraine	Surface water - Territorial (marine) water	0	0.0012	2

Perfluorononanoic acid (PFNA)	375-95-1	µg/l	Ukraine	Surface water - Territorial (marine) water	0	0.0006	2
Perfluoroundecanoic acid (PFUdA)	2058-94-8	µg/l	United Kingdom	Surface water - River water	0.01	0.1000	1
Perfluorohexanoic acid (PFHxA)	307-24-4	µg/l	United Kingdom	Surface water - River water	0.0089	0.1000	1
Perfluorododecanoic acid (PFDoDA)	307-55-1	µg/l	United Kingdom	Surface water - River water	0.05	0.1000	1
Perfluorooctanoic acid (PFOA)	335-67-1	µg/l	United Kingdom	Surface water - River water	0.03	0.1000	1
Perfluorodecanoic acid (PFDA)	335-76-2	µg/l	United Kingdom	Surface water - River water	0.005	0.1000	1
Perfluoroheptanoic acid (PFHpA)	375-85-9	µg/l	United Kingdom	Surface water - River water	0.005	0.1000	1
Perfluorononanoic acid (PFNA)	375-95-1	µg/l	United Kingdom	Surface water - River water	0.005	0.1000	1
Perfluorotetradecanoic acid (PFTeDA)	376-06-7	µg/l	United Kingdom	Surface water - River water	0.1	0.1000	1

10.2.2. Suspended particulate matter

As described in Göckener et al. (2022)), PFASs adsorb in aquatic compartments to organic carbon in sediment and suspended particulate matter (SPM). As a consequence, concentrations of both PFCA and PFSA, significantly increased with total organic carbon (TOC) in SPM from German rivers between 2005-2019 (Göckener et al., 2022). As a consequence, PFAS levels in SPM (or sediment) must be considered independent of the concentration in the water phase. Interestingly, the correlation of TOC with PFCA levels were stronger when samples were analysed by the direct total oxidizable precursor (dTOP) (vs. target), which indicates a stronger sorption of non-extractable PFCAs during target analysis. In general, differences between target and dTOP were less pronounced for PFSAs compared to PFCAs. However, both PFSAs and PFCAs show spatial differences among the German river systems between both analytical methods (Figure 43). Whereas classic PFCA target analysis resulted in comparably low levels in the river Saar, dTOP analysis revealed a relatively high contamination with previously non-extractable PFCAs (Figure 43). Similar observations were made for PFSAs in the river Saale, which (1) demonstrated the particular importance of sorption in Saar and Saale and (2) indicates potential production shifts in both rivers (Figure 43, Göckener et al. (2022))).

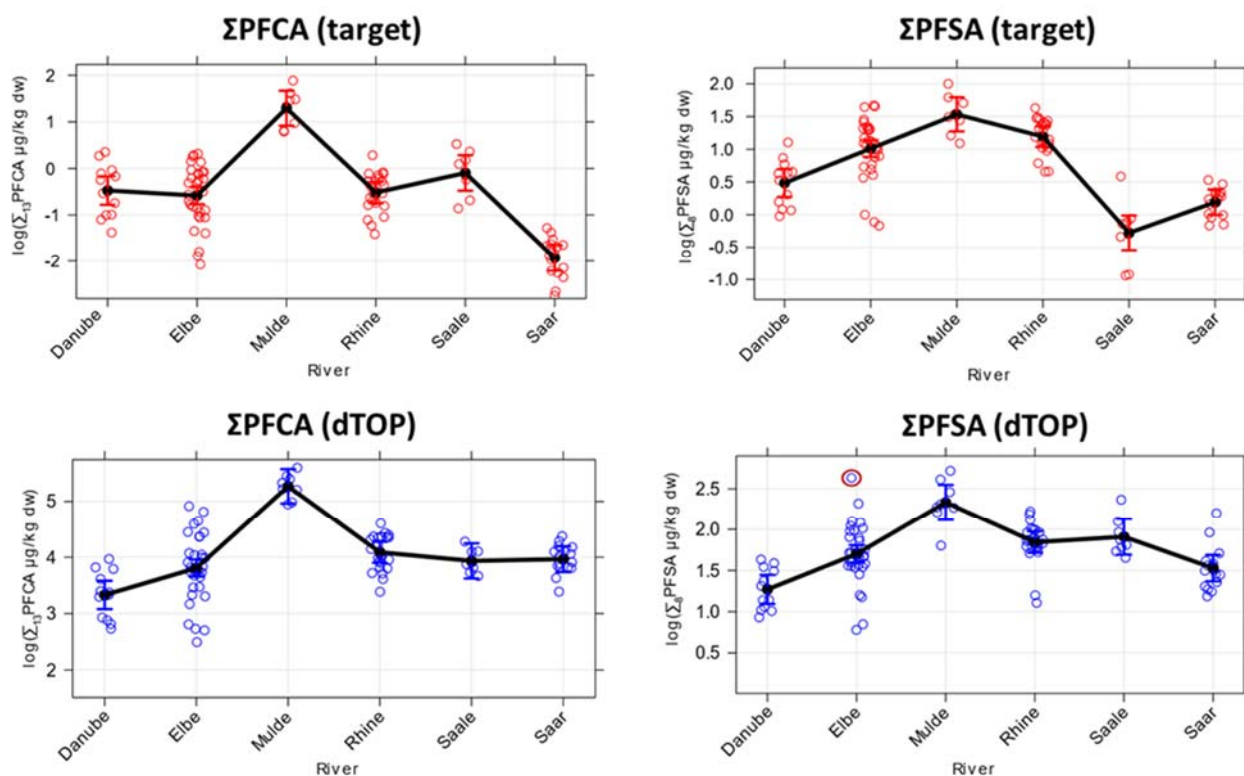

Figure 43. Differences in PFCA and PFSA levels in the main German rivers and important tributaries (Danube, Elbe, Mulde, Rhine, Saale, Saar) in suspended particulate matter (2005-2019) taken from Göckener et al. (2022)). Samples were analysed by classical target analysis (red) and direct Total Oxidizable Precursor (dTOP) Assay (blue). Spatial analysis took variations in sampling year (see Figure 51) and total organic carbon content into account. The red circle indicates an outlier.

In general, concentrations in SPM from Germany (Σ PFAS: $0.34\text{--}14.9\ \mu\text{g kg}^{-1}$) were considerably lower compared to those in muscle of bream (*Abramis brama*) (Σ PFAS: $\sim 4.35\text{--}41.7\ \mu\text{g kg}^{-1}$) from similar sampling sites between 2017-2019 (Göckener et al., 2021). Furthermore, concentrations in SPM from the Gironde Estuary in France tended to be lower in 2012/13 (Σ PFAS: $1.3\text{--}5.6\ \mu\text{g kg}^{-1}$) compared to SPM from Germany (Munoz et al., 2019). In 2014, concentrations in SPM from the Gironde Estuary in France reported Σ PFAS concentrations between $3.3\text{--}10\ \mu\text{g kg}^{-1}$ in subsurface water and $2.8\text{--}6.1\ \mu\text{g kg}^{-1}$ in bottom water samples (Munoz et al., 2017a).

Taken together, the study by Göckener et al. (2022)) demonstrates that conventional target analysis seems to overlook emerging PFAS contamination and production shifts as it is mainly focussed on already regulated substances. Therefore, novel analytical techniques such as the dTOP assay are necessary for comprehensive spatial and temporal assessments (see section below on time trends).

10.2.3. Occurrence of PFASs in Soil

Table presenting the levels of measured PFASs in soil is at the bottom of this section (Table 21).

There are generally fewer studies and data which describe the occurrence of PFASs in soil than in water. (Brusseau et al., 2020) analysed data from scientific studies as well as the

U.S. Air Force AFFF Impacted-Site database in their current review. They compiled a dataset which contains >30,000 samples collected from >2500 sites worldwide. Due to the fact that methods for sampling and analysis varied among the different studies, the authors focused their analysis on maximum reported concentrations for PFOA and PFOS as these substances were measured in each study. The number of PFAS analyzed, in the studies compiled for that review, ranged from 2 to 32, with a mean of 14. Total PFAS concentrations ranged from <0.001 to 237 µg/kg. PFOS and PFOA were the most prevalent PFASs reported for almost all of the studies (Brusseau et al., 2020). Due to the focus on PFOA, PFOS, there is a lack of data for short-chain PFASs and novel replacement substances such as HFPO-DA. Additionally, it has to be assumed that only substances for which standards are commonly available have been analysed in the studies compiled by (Brusseau et al., 2020). NTS or total-fluorine measurements were not included in the review. In consequence, there is still a gap of knowledge regarding PFASs levels in soil. Nonetheless, the data compiled by Brusseau et al in combination with data from the NORMAN database (Norman database, 2021)) provides a good overview of PFASs levels in soil.

Concentrations reported for PFAS-contaminated sites were generally orders-of-magnitude greater than ambient background levels. It is noteworthy that soil concentrations reported for PFASs at contaminated sites are often orders-of-magnitude higher than typical groundwater concentrations. The results of the review from (Brusseau et al., 2020) demonstrate that PFASs are present in soils across the globe, and indicate that soil is a significant reservoir for PFASs. A critical question of concern is the long-term migration potential to surface water, groundwater, and the atmosphere as well as potential human exposure via the soil-groundwater-drinking water-path or the soil-groundwater-nutrition (plant or animal) path.

Table 21. Collection of the levels detected in soil.

PFASs	CAS	Unit	Min	Max	Country	Matrix	Number of studies
PFOS	1763-23-1	ng/g dw	< LOQ	49	Austria	soil	2
PFUnDA	2058-94-8	ng/g dw	0.10	0.35	Austria	soil	1
PFHxA	307-24-4	ng/g dw	0.18	0.34	Austria	soil	1
PFDoDA	307-55-1	ng/g dw	0.1	0.21	Austria	soil	1
PFOA	335-67-1	ng/g dw	< LOQ	5	Austria	soil	2
PFDA	335-76-2	ng/g dw	0.23	0.88	Austria	soil	1
PFHxS	355-46-4	ng/g dw	0-0,050	0.14	Austria	soil	1
PFHpA	375-85-9	ng/g dw	0.13	4.1	Austria	soil	1
PFHpS	375-92-8	ng/g dw	0-0.06	0.14	Austria	soil	1
PFNA	375-95-1	ng/g dw	0.18	0.65	Austria	soil	1
PFDS				0-			
	39108-34-4	ng/g dw		0.050	Austria	soil	1
N-Ethyl-Perfluorooctane sulfonamide				0-0.1			
	4151-50-2	ng/g dw			Austria	soil	1
Perfluorooctansulfonamide			0.10				
	754-91-6	ng/g dw		1	Austria	soil	1
PFODA	16517116	ng/g dw		<0.20	Belgium	soil	*
PFOS	1763-23-1	ng/g dw	<0,2	2.1	Belgium	soil	*
PFUdA	2058-94-8	ng/g dw		<0.20	Belgium	soil	*

ANNEX XV RESTRICTION REPORT – PFAS IN FIREFIGHTING FOAMS

PFPeA	2706-90-3	ng/g dw	<0.20	0.36	Belgium	soil	*
PFPeS	2706-91-4	ng/g dw		<0.20	Belgium	soil	*
6:2 FTS	27619-97-2	ng/g dw	<0,2	1	Belgium	soil	*
PFHxA	307-24-4	ng/g dw	<0.20	0.39	Belgium	soil	*
PFDoA	307-55-1	ng/g dw		<0.20	Belgium	soil	*
PFOA	335-67-1	ng/g dw	<0,2	2.2	Belgium	soil	*
PFDA	335-76-2	ng/g dw	<0.20	0.21	Belgium	soil	*
PFHxS	355-46-4	ng/g dw		<0.20	Belgium	soil	*
PFBA	375-22-4	ng/g dw	0.35	2.6	Belgium	soil	*
PFBS	375-73-5	ng/g dw	<0.20	0.3	Belgium	soil	*
PFHpA	375-85-9	ng/g dw	<0.20	0.27	Belgium	soil	*
PFHpS	375-92-8	ng/g dw		<0.20	Belgium	soil	*
PFNA	375-95-1	ng/g dw	<0.20	0.24	Belgium	soil	*
PFTeDA	376-06-7	ng/g dw		<0.20	Belgium	soil	*
PFDS	39108-34-4	ng/g dw		<0.20	Belgium	soil	*
PFHxDA	67905-19-5	ng/g dw		<0.20	Belgium	soil	*
PFNS	68259-12-1	ng/g dw		<0.20	Belgium	soil	*
PFTrDA	72629-94-8	ng/g dw		<0.20	Belgium	soil	*
	757124-72-			<0.20			*
4:2 FTS	4	ng/g dw			Belgium	soil	
PFHxDA		ng/g dw		<0.20	Belgium	soil	*
PFDoS		ng/g dw		<0.20	Belgium	soil	*
8:2/10:2 disubstituted polyfluoroalkyl phosphate (8:2/10:2 diPAP)	1158182- 60-5	ng/g dw	0.15	0.15	German y	soil	1
2,3,3,3- Tetrafluoro-2- (1,1,2,2,3,3,3,- heptafluoropropox y)-propanoic acid (HFPO-DA)	13252-13-6	ng/g dw	0.15	0.15	German y	soil	1
7H- DoGermanycfluo roheptanoic acid (7H-PFHpA)	1546-95-8	ng/g dw	0.15	0.4	German y	soil	1
PerfluorooctaGer manycanoic acid (PFODA)	16517-11-6	ng/g dw	0.15	0.15	German y	soil	1
Perfluorooctane sulfonate (PFOS)	1763-23-1	ng/g dw	0.15	9.23	German y	soil	1
Bis[2- (perfluoroGerman ycyl)ethyl] phosphate (10:2 diPAP)	1895-26-7	ng/g dw	0.15	0.15	German y	soil	1
PerfluorounGerm anycanoic acid (PFUnDA)	2058-94-8	ng/g dw	0.15	0.66	German y	soil	1
N-Methyl perfluorooctane sulfonamido	2355-31-9	ng/g dw	0.15	0.15	German y	soil	1

ANNEX XV RESTRICTION REPORT – PFAS IN FIREFIGHTING FOAMS

acetic acid (N-MeFOSAA)								
Perfluoropentanoic acid (PFPA)	2706-90-3	ng/g dw	0.15	0.15	German y	soil		1
1H,1H,2H,2H-Perfluoro-n-octane sulfonic acid (6:2 FtS)	27619-97-2	ng/g dw	0.15	0.53	German y	soil		1
Perfluorooctanesulfonamidoacetic acid (FOSAA)	2806-24-8	ng/g dw	0.15	0.37	German y	soil		1
N-Ethylperfluorooctane sulfonamidoacetic acid (N-EtFOSAA)	2991-50-6	ng/g dw	0.15	0.15	German y	soil		1
Perfluorohexanoic acid (PFHxA)	307-24-4	ng/g dw	0.15	0.85	German y	soil		1
Perfluorododecanecarboxylic acid (PFDoDA)	307-55-1	ng/g dw	0.15	0.15	German y	soil		1
N-Methylperfluorooctanesulfonamide (N-MeFOSA)	31506-32-8	ng/g dw	0.15	0.15	German y	soil		1
Perfluorooctanoic acid (PFOA)	335-67-1	ng/g dw	0.15	3.88	German y	soil		1
Perfluorodecanecarboxylic acid (PFDA)	335-76-2	ng/g dw	0.15	0.69	German y	soil		1
Perfluorodecane sulfonate (PFDS)	335-77-3	ng/g dw	0.15	0.15	German y	soil		1
Perfluorohexane sulfonate (PFHxS)	355-46-4	ng/g dw	0.15	0.15	German y	soil		1
Perfluorobutanoic acid (PFBA)	375-22-4	ng/g dw	0.15	2.09	German y	soil		1
Perfluorobutane sulfonate (PFBS)	375-73-5	ng/g dw	0.15	0.15	German y	soil		1
Perfluoroheptanoic acid (PFHpA)	375-85-9	ng/g dw	0.15	1.42	German y	soil		1
Perfluoroheptane sulfonate (PFHpS)	375-92-8	ng/g dw	0.15	0.15	German y	soil		1
Perfluorononanoic acid (PFNA)	375-95-1	ng/g dw	0.15	1.79	German y	soil		1
Perfluorotetradecanecarboxylic acid (PFTeDA)	376-06-7	ng/g dw	0.15	0.15	German y	soil		1
1H,1H,2H,2H-Perfluoro-n-decane sulfonic acid (8:2 FtS)	39108-34-4	ng/g dw	0.15	0.15	German y	soil		1
N-Ethylperfluorooctane	4151-50-2	ng/g dw	0.15	0.15	German y	soil		1

ANNEX XV RESTRICTION REPORT – PFAS IN FIREFIGHTING FOAMS

sulfonamiGerman y (N-EtFOSA)							
Pentafluoropropionic acid (PFPrA)	422-64-0	ng/g dw	0.15	0.15	German y	soil	1
Bis[2-(perfluorohexyl)ethyl] phosphate (6:2 diPAP)	57677-95-9	ng/g dw	0.15	7.02	German y	soil	1
Mono[2-(perfluorohexyl)ethyl] phosphate (6:2 PAP)	57678-01-0	ng/g dw	0.15	0.15	German y	soil	1
Mono[2-(perfluorooctyl)ethyl] Phosphate (8:2 PAP)	57678-03-2	ng/g dw	0.15	0.15	German y	soil	1
Bis[2-(perfluorooctyl)ethyl] phosphate (8:2 diPAP)	678-41-1	ng/g dw	0.15	0.15	German y	soil	1
Perfluorohexamylanoic acid (PFHxDA)	67905-19-5	ng/g dw	0.15	0.15	German y	soil	1
Perfluorotrihexamylanoic acid (PFTrDA)	72629-94-8	ng/g dw	0.15	0.15	German y	soil	1
PerfluorooctanesulfonamiGermany (PFOSA)	754-91-6	ng/g dw	0.15	0.15	German y	soil	1
1H,1H,2H,2H-Perfluoro-n-hexanesulfonic acid (4:2 FtS)	757124-72-4	ng/g dw	0.15	0.15	German y	soil	1
6:2/8:2 Fluorotelomer phosphate diester (6:2/8:2 diPAP)	943913-15-3	ng/g dw	0.15	0.15	German y	soil	1
10:2 FTSA		ng/g dw	<0.024	n.a.	Sweden	soil	1
6:2 FTSA		ng/g dw	<0.75	2.96	Sweden	soil	1
8:2 FTSA		ng/g dw	<0.24	n.a.	Sweden	soil	1
EtFOSA		ng/g dw	<0.24	n.a.	Sweden	soil	1
EtFOSAA		ng/g dw	<0.24	n.a.	Sweden	soil	1
EtFOSE		ng/g dw	<0.024	n.a.	Sweden	soil	1
FOSA		ng/g dw	<0.018	0.65	Sweden	soil	1
FOSAA		ng/g dw	<0.090	0.88	Sweden	soil	1
MeFOSA		ng/g dw	<0.24	n.a.	Sweden	soil	1
MeFOSAA		ng/g dw	<0.0048	n.a.	Sweden	soil	1
MeFOSE		ng/g dw	<0.24	n.a.	Sweden	soil	1
PFBA		ng/g dw	<3.9	n.a.	Sweden	soil	1
PFBS		ng/g dw	<0.038	0.96	Sweden	soil	1
PFDA		ng/g dw	<0.0083	0.68	Sweden	soil	1
PFDoDA		ng/g dw	<0.024	0.33	Sweden	soil	1
PFDS		ng/g dw	<0.0048	n.a.	Sweden	soil	1
PFHpA		ng/g dw	<0.024	0.44	Sweden	soil	1

PFHxA	ng/g dw	<8.8	n.a.	Sweden	soil	1
PFHxDA	ng/g dw	<0.024	n.a.	Sweden	soil	1
PFHxS	ng/g dw	<0.045	0.4	Sweden	soil	1
PFNA	ng/g dw	<0.016	0.7	Sweden	soil	1
PFOA	ng/g dw	<0.024	0.57	Sweden	soil	1
PFOcDA	ng/g dw	<0.049	0.08	Sweden	soil	1
PFOS	ng/g dw	<0.024	1.7	Sweden	soil	1
PFTeDA	ng/g dw	<0.24	0.64	Sweden	soil	1
PFTriDA	ng/g dw	<0.024	8.3	Sweden	soil	1
PFUnDA	ng/g dw	<0.014	0.76	Sweden	soil	1

* no information on data owner

10.2.4. Ambient concentrations in soil

Concentration ranges in “uncontaminated” soils were reported by (Brusseau et al., 2020) to be < 0,001 – 237 µg/kg for total PFAS concentrations. PFOA background concentrations are 0,01 – 123,6 µg/kg (median = 2.7 µg/kg) and PFOS background concentrations range from 0,003 – 162 µg/kg (median = 2.7 µg/kg) (Brusseau et al., 2020). These ranges are based on 38 studies with > 5700 sample from > 1400 sampling locations. It should be mentioned, that the median values have to be treated care. They are suitable to get an idea of the order of magnitude of the mean concentrations of PFASs in soil. However, scientifically speaking, the calculation of median values from studies that applied different methods for sampling and analysis is not suitable to derive robust, quantitative mean values. Brusseau et al provided information, that sample locations were in both urban and rural areas.

Data from remote areas, where direct human activity is considered absent, have been published in another study (Rankin et al., 2016). They reported PFASs soil concentrations for a single sampling site located in Antarctica (ΣPFCA 191 pg/g dry-weight (dw), ΣPFSA 7 pg/g dw). PFOA and PFOS concentrations were 0.05 and 0.007 µg/kg, respectively. The authors conclude that the results suggest that the atmospheric long-range transport (LRT) of neutral PFASs followed by oxidation and deposition are a significant source of PFCAs and PFASs to soils. The PFOS and PFOA concentrations reported for this study are significantly lower than concentrations reported for all of the other studies.

PFASs in agricultural fields are a potential point of entry into the food web. In their review Brusseau and co-workers highlight that results from a number of the studies, that focused on assessing PFAS occurrence in agricultural fields, show widespread presence.

10.2.5. Contaminated sites

Contaminated sites include PFAS manufacturing sites, fire training sites and other AFFF-associated locations at airports and military installations, and a crash site. See section E.4.3.5.2 for some further case examples directly related to firefighting. The secondary-source sites include sites that are adjacent to PFAS-contaminated primary-source sites, or sites for which PFAS-contaminated media were used for different purposes. These latter sites represent for example locations at which biosolids and other amendments were applied to the ground surface, and/or sites at which surface water, groundwater, or treated wastewater was used for irrigation.

Cases of land application of industrial-waste derived amendment are for instance described in the study by (Wilhelm et al., 2008). Industrial waste with high concentrations of PFASs was manufactured into a soil improver by a recycling company and spread by farmers on agricultural land of the rural area Sauerland, Germany. This led to substantial environmental pollution and had an impact on drinking water. A second site with a similar cause of contamination is located in Rastatt in Germany (Brendel et al., 2018). It should be noted that these cases were discovered by chance. Other cases may be yet undetected. Consequently, the use of PFAS-contaminated media such as biosolids and irrigation water can result in soil contamination, subsequent distribution to other media, and ultimately the potential for human exposure at locations far from the original PFAS source (Liu et al., 2017b, Lindstrom et al., 2011).

For primary contaminated sites (i.e. with direct source of contamination) the study by Brusseau et al (Brusseau et al., 2020) reports maximum PFOA concentrations in the range from 2 µg/kg - >50.000 µg/kg (median 83 µg/kg). Maximum PFOS concentrations range from 0.4 µg/kg - 460,000 µg/kg (median 8722 µg/kg). This is based on 22 studies with samples from > 1000 sampling locations. The number of samples as well as ranges for total PFAS concentrations were not reported.

Secondary source sites have the following background concentrations: PFOAMax: 0,8 µg/kg - 2531 µg/kg (Median 38 µg/kg), PFOSMax 0,4 µg/kg - 5500 µg/kg (Median 680.5 µg/kg) (Brusseau et al., 2020). The authors derive this estimation from 10 studies, from 9 sites. The number of samples as well as ranges for total PFAS concentrations were not reported.

One point of interest is the relative ranges of soil versus groundwater concentrations reported for PFASs (Hunter Anderson et al., 2019). The ratios were positive for the vast majority (87%) of data, reflecting greater soil than groundwater concentrations. In this context soil concentrations ~100-times greater than groundwater were observed. This may pose a long-term source for groundwater contamination due to leaching. In this context soil monitoring studies investigating depth profiles of PFASs can reveal how PFASs with different properties distribute in soil. The basic assumption is, that the differing physico-chemical properties of different PFASs lead to differences in their distribution within the soil column (e.g.,(Buck et al., 2011), (Washington et al., 2010), (Sepulvado et al., 2011),(Baduel et al., 2017), (Casson and Chiang, 2018), (Dauchy et al., 2018)). This leads to different PFASs concentrations being found depending on the depth the samples were taken from. Brusseau et al (based on findings from the above-mentioned studies) described a trend according to which the greatest concentration of long-chain PFASs ($\geq C7$, referring to (Buck et al., 2011) are mostly found closer towards the surface (within 1 m, according to (Baduel et al., 2017)). Accordingly, maximum concentrations for short-chain PFASs are measured at greater depths (> 2 m according to (Baduel et al., 2017)). Brusseau et al 2020 summarize the observations from different studies as follows: "The majority of depth-profile data sets show high concentrations present at shallow depths and exponential decreases at greater depths".

Following examples are provided to support the link between the mobile and persistent properties of PFASs and the type of contamination. Not all of the cases are directly linked with the use of PFASs in firefighting foams.

Examples from Europe

In the surroundings of Rastatt (Baden-Wuerttemberg, Germany), 480 hectares of former arable land are contaminated with short-chain PFASs. The pollution was detected in 2013 and has probably been caused by the longstanding application of compost mixed with sludge from paper production, contaminated with various precursors. Over time, shorter chained PFASs and precursors in the soil wash out into the groundwater. Two groundwater wells for drinking water production had to be closed. Until now, no practicable solution for removing the short-chain PFASs from the soil or groundwater has been found. Furthermore, there are still high concentrations of PFASs (Brendel et al., 2018).

In Italy, on January 2014, drinking water contamination in an area of the Veneto Region was detected mainly due to the drain of fluorinated chemicals by a manufacturing company operating since 1964. More details on the drinking water contamination are provided in this section under "Drinking water concentrations".

Drinking water works in the municipality of Kallinge, Sweden were immediately closed down after contamination of the groundwater was discovered near a Swedish Air Force and civil aviation base where AFFFs have been used (Jakobsson et al., 2014).

Field investigations were carried out in the vicinity of four sites where AFFFs are or were intensively used (two airports, a training center for firefighters and an oil storage depot after a large explosion). In case of the incident of a fire at oil storage depot Twenty-eight years had passed until the field investigation. PFAS profiles were influenced by parameters such as route of PFAS transport after use (runoff, seepage, direct discharge), time elapsed since the cessation of firefighting activities, and firefighting foam composition. The PFAS concentrations found around the investigated sites are the highest recorded in France.

A study investigated the impact of two fluoropolymer manufacturing facilities on downstream contamination of a river and drinking water resources. The impact on the water quality of the drinking water resources was clearly demonstrated. The total PFAS concentrations are the highest detected in France to date (Bach C. et al).

Examples outside Europe

In June 2000, 22000 L of fire retardant foam containing perfluorinated surfactants was accidentally released at L. B. Pearson International Airport, Toronto, ON, and subsequently entered into Etobicoke Creek, a tributary to Lake Ontario. This incidence may be seen as an involuntary long-term field study on the distribution of PFASs. For instance even a decade after the spill, sediment PFOS concentrations are still elevated in Spring Creek Pond which received the foam discharge. The first study monitored PFASs in biota and surface water samples (Moody et al., 2002) The second study examined spatial and long-term (9 year) temporal trends of PFASs in water, sediment, fish, and fish liver collected in 2003, 2006, and 2009 from 10 locations spanning ~20 km in Etobicoke and Spring Creeks. Field-based sediment/water distribution coefficients (K_D) and bioaccumulation factors (BAF) were calculated from environmental measurements (Awad E. et al).

The decades-long disposal of manufacturing waste containing PFASs in landfills in Minnesota resulted in contamination of groundwater serving as the drinking water supply for the eastern Twin Cities metropolitan region. In 2004, local and state agencies in Minnesota were alerted to the presence of PFASs in the drinking water supplies of several eastern Twin Cities suburbs. A study conducted in 2010, six years after the discovery, measured PFASs in garden produce due to past/ongoing water contamination (Deanna P. Scher).

10.2.6. Soil as a global reservoir

The potential importance of soil as a global reservoir for PFASs was first quantified by Strynar et al. (Strynar et al., 2012) who measured the concentrations of 13 PFASs in samples of surface soil collected from 60 locations in 6 countries. Strynar et al. estimated global soil loadings of 1860 and >7000 t of PFOA and PFOS, respectively. Rankin et al. (Rankin et al., 2016) reported concentrations of 32 PFASs in surface soil samples collected from 62 locations across all continents. Quantifiable levels of more than one PFASs were present in all samples tested, including soils collected from remote locations. Washington et al. (Washington et al., 2019) used data from the Rankin et al. (2016) to calculate global soil loadings for 8 PFASs. The combined estimated load for all 8 PFASs ranged from 1500 to 9000 t, with mean estimates of approximately 1000 t for both PFOA and PFOS. These results indicate that soil has the potential to be a substantial reservoir for PFASs.

Another study (Hunter Anderson et al., 2019) reported a meta-analysis of PFASs soil-to-groundwater concentration ratios for samples collected from 324 AFFF source-zone sites across 56 military installations distributed throughout the U.S. The results demonstrated that soil is a significant reservoir for PFASs at these contaminated sites. Transport modeling conducted at individual contaminated sites also indicates that soils and the vadose zone serve as a significant long-term source of PFASs (Weber et al., 2017).

10.2.7. Drinking water concentrations

A recent global survey found a widespread distribution of SC-PFAAs in drinking water (Kaboré et al., 2018), with PFBA being detected in 58% of bottled water and 92% of tap water, PFPeA detected in 32% of bottled water and 68% of tap water, PFHxA in 50% of bottled water and 64% of tap water, PFFpA in 42% of bottled water and 90% of tap water, PFBs in 47% of bottled water and 88% of tap water.

PFASs have been detected in European drinking waters according to the NORMAN data (see Table 22). In drinking/tap water, the levels of long-chain PFASs such as PFOA, PFOS and PFHxS were the highest in Italy (up to 1886 ng/L for PFOA, 150 ng/L for PFOS and 141 ng/L for PFHxS). PFOS also has reached concentrations of 46 ng/L in Spain, PFNA of 12 ng/L in Italy and PFOA of 6.2 ng/L in Germany. Same trend has been observed for short-chain PFASs - the highest concentrations have been measured in Italian drinking/tap water: up to 556 ng/L (PFBA), 347 ng/L (PFBS), 267 ng/L (PFPeA), 240 ng/L (PFHxA) and 100 ng/L (PFHpA). PFBA has been detected up to 10 ng/L in tap water in Spain, PFBS up to 8.30 ng/L in Spain, PFHpA up to 8.10 and 1.24 ng/L in Spain and France, PFHxA up to 4.70 and 3.7 ng/L in Spain and France, and PFPeA up to 3.80 and 2.75 ng/L in Spain and France. Other PFASs have been also detected in tap water but the concentrations have been mostly below 1 ng/L.

PFASs have been also measured in bottled drinking water in Europe. Highest concentrations were for PFOS: 40 ng/L in Spain, 20.61 ng/L in France, and 5 ng/L in Italy. Other long-chain PFASs have been also measured in bottled water, such as PFOA (14 ng/L in Spain and 13 ng/L in France), PFHxS (10 ng/L in Italy), PFDA (18 ng/L in Spain and 12 ng/L in France), PFTeA (18 ng/L in France), PFDS (up to 9.1 ng/L in France) and PFNA (up to 19 ng/L in Spain). Also short-chain PFASs have been measured in bottled drinking water: e.g. PFHxA (up to 36 ng/L in Spain and 6.3 ng/L in France), PFHpA (up to 19 ng/L in Spain and 22 ng/L in France), PFBS (up to 11 ng/L in Spain and 6.8 ng/L in France).

Table 22. Collection* of the PFAS levels detected in drinking water/tap water and bottled drinking water.

PFAS	CAS	Country	Matrix	Unit	Min	Max	Number of studies
perfluorobutanesulfonate - pfb	375-73-5	Germany	tap water	ng/L	<0,11	1.3	2
perfluorobutanoic acid - pfba	375-22-4	Germany	tap water	ng/L	0.4	0.6	2
perfluorodecanoic acid - pfda	335-76-2	Germany	tap water	ng/L	< 0,19	0.3	2
perfluorododecanoic acid - pfdoa	307-55-1	Germany	tap water	ng/L	<LOD	1.8	2
perfluoroheptanoic acid - pfhpa	375-85-9	Germany	tap water	ng/L		0.2	1
perfluorohexane sulfonate - pfhxs	355-46-4	Germany	tap water	ng/L		<0,06	1
perfluorohexanoic acid - pfhxa	307-24-4	Germany	tap water	ng/L		0.9	1
perfluorononanoic acid - pfna	375-95-1	Germany	tap water	ng/L	<0,03	0.4	2
perfluorooctane sulfonate - pfos	1763-23-1	Germany	tap water	ng/L		0.4	1
perfluorooctanoic acid - pfoa	335-67-1	Germany	tap water	ng/L	1.3	6.2	2
perfluoropentanoic acid - pfpea	2706-90-3	Germany	tap water	ng/L		1.2	1
perfluoroheptanoic acid - pfhpa	375-85-9	Thailand	tap water	ng/L		0.28	1
perfluorohexanoic acid - pfhxa	307-24-4	Thailand	tap water	ng/L		0.13	1
perfluorooctane sulfonate - pfos	1763-23-1	Thailand	tap water	ng/L		0.18	1
perfluorooctanoic acid - pfoa	335-67-1	Thailand	tap water	ng/L		3.6	1
perfluorooctane sulfonate - pfos	1763-23-1	Australia	drinking water	ng/L	0	16	1
perfluorooctanoic acid - pfoa	335-67-1	Australia	drinking water	ng/L	0	9.7	1
perfluorooctane sulfonate - pfos	1763-23-1	China	tap water	ng/L	1.2	14	1
perfluorooctanoic acid - pfoa	335-67-1	China	tap water	ng/L	6.8	40	1
L-PFOS		Faroe Islands	drinking water	ng/L	0.17	61	1
perfluorobutanesulfonate - pfb	375-73-5	Faroe Islands	drinking water	ng/L	0.008	0.016	1
perfluorobutanoic acid - pfba	375-22-4	Faroe Islands	drinking water	ng/L	0.57	0.82	1
perfluorodecanoic acid - pfda	335-76-2	Faroe Islands	drinking water	ng/L	0.027	0.032	1

ANNEX XV RESTRICTION REPORT – PFAS IN FIREFIGHTING FOAMS

perfluoroheptanoic acid - pfhpa	375-85-9	Faroe Islands	drinking water	ng/L	0.208	0.22	1
perfluorohexane sulfonate - pfhxs	355-46-4	Faroe Islands	drinking water	ng/L	0.028	0.047	1
perfluorohexanoic acid - pfhxa	307-24-4	Faroe Islands	drinking water	ng/L	<0,067	0.08	1
perfluorononanoic acid - pfna	375-95-1	Faroe Islands	drinking water	ng/L	0.16	0.17	1
perfluoro-n-undecanoic acid - pfuna	2058-94-8	Faroe Islands	drinking water	ng/L	0.03	0.056	1
perfluorooctanoic acid - pfoa	335-67-1	Faroe Islands	drinking water	ng/L	0.23	0.25	1
perfluorooctanoic acid - pfoa	335-67-1	Ireland	tap water	ng/L	0.23	0.61	1
perfluorooctane sulfonate - pfos	1763-23-1	Ireland	tap water	ng/L		<0,15	1
perfluorobutanesulfonate - pfbs	375-73-5	Ireland	tap water	ng/L		<0,2	1
perfluorononanoic acid - pfna	375-95-1	Ireland	tap water	ng/L		<0,05	1
perfluorobutanesulfonate - pfbs	375-73-5	France	tap water	ng/L	0.16	0.72	1
perfluorobutanoic acid - pfba	375-22-4	France	tap water	ng/L	0.91	1.56	1
perfluorodecanoic acid - pfda	335-76-2	France	tap water	ng/L		0.16	1
perfluoroheptanoic acid - pfhpa	375-85-9	France	tap water	ng/L	0.35	1.24	1
perfluorohexane sulfonate - pfhxs	355-46-4	France	tap water	ng/L	<LOQ	0.55	1
perfluorohexanoic acid - pfhxa	307-24-4	France	tap water	ng/L	0.28	3.7	1
perfluorononanoic acid - pfna	375-95-1	France	tap water	ng/L		0.32	1
perfluoro-n-undecanoic acid - pfuna	2058-94-8	France	tap water	ng/L		0.18	1
perfluorooctane sulfonate - pfos	1763-23-1	France	tap water	ng/L	0.17	1.13	1
perfluorooctanoic acid - pfoa	335-67-1	France	tap water	ng/L	0.4	0.6	1
perfluoropentanoic acid - pfpea	2706-90-3	France	tap water	ng/L	2.32	2.75	1
perfluorobutanoic acid - pfba	375-22-4	Guadeloupe, French West Indies	tap water	ng/L		1.15	1
perfluoropentanoic acid - pfpea	2706-90-3	Guadeloupe, French West Indies	tap water	ng/L		0.52	1

ANNEX XV RESTRICTION REPORT – PFAS IN FIREFIGHTING FOAMS

perfluoroheptanoic acid - pfhpa	375-85-9	Guadeloupe, French West Indies	tap water	ng/L	0.72		1
perfluorobutanesulfonate - pfbis	375-73-5	Italy	drinking water	ng/L	1	347	1
perfluorobutanoic acid - pfba	375-22-4	Italy	drinking water	ng/L	7	556	1
perfluorodecanoic acid - pfda	335-76-2	Italy	drinking water	ng/L	0.5	5.4	1
perfluorododecanoic acid - pfdoa	307-55-1	Italy	drinking water	ng/L	1	8.5	1
perfluoroheptanoic acid - pfhpa	375-85-9	Italy	drinking water	ng/L	1	100	1
perfluorohexane sulfonate - pfhxs	355-46-4	Italy	drinking water	ng/L	5.9	141	1
perfluorohexanoic acid - pfhxa	307-24-4	Italy	drinking water	ng/L	0.5	240	1
perfluorononanoic acid - pfna	375-95-1	Italy	drinking water	ng/L	0.5	12	1
perfluoro-n-undecanoic acid - pfuna	2058-94-8	Italy	drinking water	ng/L	0.5	3.7	1
perfluorooctane sulfonate - pfos	1763-23-1	Italy	drinking water	ng/L	2.5	150	1
perfluorooctanoic acid - pfoa	335-67-1	Italy	drinking water	ng/L	1.5	1886	1
perfluoropentanoic acid - pfpea	2706-90-3	Italy	drinking water	ng/L	1	267	1
perfluorohexanoic acid - pfhxa	307-24-4	Japan	tap water	ng/L	1.81	4.4	1
perfluoroheptanoic acid - pfhpa	375-85-9	Japan	tap water	ng/L	1.78	9.53	1
perfluorooctanoic acid - pfoa	335-67-1	Japan	tap water	ng/L	6.17	10.74	1
perfluorononanoic acid - pfna	375-95-1	Japan	tap water	ng/L	0.81	2.74	1
perfluorodecanoic acid - pfda	335-76-2	Japan	tap water	ng/L	0.308	8.844	1
perfluoro-n-undecanoic acid - pfuna	2058-94-8	Japan	tap water	ng/L	0.235	0.276	1
perfluorohexanoic acid - pfhxa	307-24-4	Japan	well water	ng/L		109 531	1
perfluoroheptanoic acid - pfhpa	375-85-9	Japan	well water	ng/L		31 695	1
perfluorooctanoic acid - pfoa	335-67-1	Japan	well water	ng/L		778 123	1
perfluorononanoic acid - pfna	375-95-1	Japan	well water	ng/L		11.20	1
perfluorodecanoic acid - pfda	335-76-2	Japan	well water	ng/L		3 675	1

ANNEX XV RESTRICTION REPORT – PFAS IN FIREFIGHTING FOAMS

perfluoro-n-undecanoic acid - pfuna	2058-94-8	Japan	well water	ng/L		1 355		1
perfluorohexane sulfonate - pfhxs	355-46-4	Korea	tap water	ng/L		0.785		1
perfluorooctane sulfonate - pfos	1763-23-1	Korea	tap water	ng/L		2.62		1
perfluorohexanoic acid - pfhxa	307-24-4	Korea	tap water	ng/L		11.70		1
perfluoroheptanoic acid - pfhpa	375-85-9	Korea	tap water	ng/L		4.85		1
perfluorooctanoic acid - pfoa	335-67-1	Korea	tap water	ng/L		12.90		1
perfluorononanoic acid - pfna	375-95-1	Korea	tap water	ng/L		2.66		1
perfluorodecanoic acid - pfda	335-76-2	Korea	tap water	ng/L		1.19		1
perfluoro-n-undecanoic acid - pfuna	2058-94-8	Korea	tap water	ng/L		0.024		1
perfluorododecanoic acid - pfdoa	307-55-1	Korea	tap water	ng/L		0.05		1
perfluorobutanesulfonate - pfbs	375-73-5	Korea	tap water	ng/L		0.801		1
perfluorohexane sulfonate - pfhxs	355-46-4	Netherlands	tap water	ng/L	0.55	0.6		1
perfluorooctane sulfonate - pfos	1763-23-1	Netherlands	tap water	ng/L	<0,23	<0,3		1
perfluorohexanoic acid - pfhxa	307-24-4	Netherlands	tap water	ng/L	2.3	4.4		1
perfluoroheptanoic acid - pfhpa	375-85-9	Netherlands	tap water	ng/L	1.2	2.6		1
perfluorooctanoic acid - pfoa	335-67-1	Netherlands	tap water	ng/L	3.7	5.1		1
perfluorononanoic acid - pfna	375-95-1	Netherlands	tap water	ng/L		<0,24		1
perfluorodecanoic acid - pfda	335-76-2	Netherlands	tap water	ng/L	<0,04	<0,09		1
perfluorobutanoic acid - pfba	375-22-4	Netherlands	tap water	ng/L	15	30		1
perfluorobutanesulfonate - pfbs	375-73-5	Netherlands	tap water	ng/L	16	20		1
perfluoropentanoic acid - pfpea	2706-90-3	Netherlands	tap water	ng/L	2.4	2.6		1
perfluorobutanesulfonate - pfbs	375-73-5	Netherlands	drinking water	ng/L	0.54	19		2
perfluorobutanoic acid - pfba	375-22-4	Netherlands	drinking water	ng/L	<2	13		2
perfluorodecanoic acid - pfda	335-76-2	Netherlands	drinking water	ng/L	<0,03	<0,5		2

ANNEX XV RESTRICTION REPORT – PFAS IN FIREFIGHTING FOAMS

perfluorododecanoic acid - pfdoa	307-55-1	Netherlands	drinking water	ng/L	<0,5		1
perfluoroheptanoic acid - pfhpa	375-85-9	Netherlands	drinking water	ng/L	<0,05	3.1	2
perfluorohexane sulfonate - pfhxs	355-46-4	Netherlands	drinking water	ng/L	0.02	1.3	2
perfluorohexanoic acid - pfhxa	307-24-4	Netherlands	drinking water	ng/L	<0,1	5.9	2
perfluorononanoic acid - pfna	375-95-1	Netherlands	drinking water	ng/L	<0,03	0.28	2
perfluoro-n-undecanoic acid - pfuna	2058-94-8	Netherlands	drinking water	ng/L		<0,5	1
perfluorooctane sulfonate - pfos	1763-23-1	Netherlands	drinking water	ng/L	<0,03	2.6	2
perfluorooctanoic acid - pfoa	335-67-1	Netherlands	drinking water	ng/L	<0,3	11	2
perfluoropentanoic acid - pfpea	2706-90-3	Netherlands	drinking water	ng/L	<4	5.1	1
perfluorobutanesulfonate - pfbs	375-73-5	Norway	tap water	ng/L		0.32	1
perfluorohexane sulfonate - pfhxs	355-46-4	Norway	tap water	ng/L		0.39	1
perfluorooctane sulfonate - pfos	1763-23-1	Norway	tap water	ng/L		0.45	1
perfluorobutanoic acid - pfba	375-22-4	Norway	tap water	ng/L		0.32	1
perfluorohexanoic acid - pfhxa	307-24-4	Norway	tap water	ng/L		0.62	1
perfluorodecanoic acid - pfda	335-76-2	Norway	drinking water	ng/L	0.22	1	1
perfluorododecanoic acid - pfdoa	307-55-1	Norway	drinking water	ng/L	0.13	0.43	1
perfluoroheptanoic acid - pfhpa	375-85-9	Norway	drinking water	ng/L	<0,12	0.76	1
perfluorohexane sulfonate - pfhxs	355-46-4	Norway	drinking water	ng/L	0.045	0.15	1
perfluorohexanoic acid - pfhxa	307-24-4	Norway	drinking water	ng/L	<0,11	0.78	1
perfluorononanoic acid - pfna	375-95-1	Norway	drinking water	ng/L		<0,22	1
perfluoro-n-undecanoic acid - pfuna	2058-94-8	Norway	drinking water	ng/L	0.065	0.35	1
perfluorooctane sulfonate - pfos	1763-23-1	Norway	drinking water	ng/L	0.071	0.31	1
perfluorooctanoic acid - pfoa	335-67-1	Norway	drinking water	ng/L	0.65	2.50	1
perfluorohexane sulfonate - pfhxs	355-46-4	Spain	tap water	ng/L		3.80	1

ANNEX XV RESTRICTION REPORT – PFAS IN FIREFIGHTING FOAMS

perfluorooctane sulfonate - pfos	1763-23-1	Spain	tap water	ng/L		46		1
perfluorohexanoic acid - pfhxa	307-24-4	Spain	tap water	ng/L		4.70		1
perfluoroheptanoic acid - pfhpa	375-85-9	Spain	tap water	ng/L		8.10		1
perfluorooctanoic acid - pfoa	335-67-1	Spain	tap water	ng/L		6.70		1
perfluorononanoic acid - pfna	375-95-1	Spain	tap water	ng/L		4.40		1
perfluorodecanoic acid - pfda	335-76-2	Spain	tap water	ng/L		2.20		1
perfluorobutanoic acid - pfba	375-22-4	Spain	tap water	ng/L		10		1
perfluorobutanesulfonate - pfbs	375-73-5	Spain	tap water	ng/L		8.30		1
perfluoropentanoic acid - pfpea	2706-90-3	Spain	tap water	ng/L		3.80		1
perfluorobutanoic acid - pfba	375-22-4	Turkey	tap water	ng/L		0.64		1
perfluoropentanoic acid - pfpea	2706-90-3	Turkey	tap water	ng/L		0.27		1
perfluorohexanoic acid - pfhxa	307-24-4	Turkey	tap water	ng/L		0.26		1
perfluoroheptanoic acid - pfhpa	375-85-9	Turkey	tap water	ng/L		0.38		1
perfluorooctanoic acid - pfoa	335-67-1	Turkey	tap water	ng/L		0.4		1
perfluorononanoic acid - pfna	375-95-1	Turkey	tap water	ng/L		0.16		1
perfluorodecanoic acid - pfda	335-76-2	Turkey	tap water	ng/L		0.13		1
perfluorobutanesulfonate - pfbs	375-73-5	Turkey	tap water	ng/L		0.29		1
perfluorohexane sulfonate - pfhxs	355-46-4	Turkey	tap water	ng/L		0.28		1
perfluorooctane sulfonate - pfos	1763-23-1	Turkey	tap water	ng/L		0.52		1
perfluorohexane sulfonate - pfhxs	355-46-4	USA	drinking water	ng/L	1.07	1.295		1
perfluorooctane sulfonate - pfos	1763-23-1	USA	drinking water	ng/L	2.57	4.025		1
perfluorohexanoic acid - pfhxa	307-24-4	USA	drinking water	ng/L	1.62	1.77		1
perfluoroheptanoic acid - pfhpa	375-85-9	USA	drinking water	ng/L	1.07	1.13		1
perfluorooctanoic acid - pfoa	335-67-1	USA	drinking water	ng/L	3.9	7.68		1
perfluorononanoic acid - pfna	375-95-1	USA	drinking water	ng/L	1.5	3.2		1

ANNEX XV RESTRICTION REPORT – PFAS IN FIREFIGHTING FOAMS

perfluorobutanoic acid - pfba	375-22-4	USA	drinking water	ng/L	9.79	51.15	1
perfluorobutanesulfonate - pfbs	375-73-5	USA	drinking water	ng/L	2.12	14.15	1
perfluoropentanoic acid - pfpea	2706-90-3	USA	drinking water	ng/L	1.26	1.83	1
perfluorooctane sulfonate - pfos	1763-23-1	Germany	mineral bottled water	ng/L		1	1
perfluorohexanoic acid - pfhxa	307-24-4	Germany	mineral bottled water	ng/L		0.17	1
perfluoroheptanoic acid - pfhpa	375-85-9	Germany	mineral bottled water	ng/L		12	1
perfluorooctane sulfonate - pfos	1763-23-1	Thailand	mineral bottled water	ng/L		0.22	1
perfluorohexanoic acid - pfhxa	307-24-4	Thailand	mineral bottled water	ng/L		0.34	1
perfluoroheptanoic acid - pfhpa	375-85-9	Thailand	mineral bottled water	ng/L		0.25	1
perfluorooctanoic acid - pfoa	335-67-1	Thailand	mineral bottled water	ng/L		10.55	1
perfluoroheptanoic acid - pfhpa	375-85-9	Brazil	mineral bottled water	ng/L		6.8	1
perfluorooctanoic acid - pfoa	335-67-1	Brazil	mineral bottled water	ng/L		7.6	1
perfluorononanoic acid - pfna	375-95-1	Brazil	mineral bottled water	ng/L		10	1
perfluorobutanesulfonate - pfbs	375-73-5	Brazil	mineral bottled water	ng/L		3.4	1
PFDS		Brazil	mineral bottled water	ng/L		15	1
PFHxDA		Brazil	mineral bottled water	ng/L		5.48	1
perfluorooctanoic acid - pfoa	335-67-1	Ireland	bottled water	ng/L		0.44	1
perfluorooctane sulfonate - pfos	1763-23-1	Ireland	bottled water	ng/L		<0.15	1
perfluorobutanesulfonate - pfbs	375-73-5	Ireland	bottled water	ng/L		<0.2	1

ANNEX XV RESTRICTION REPORT – PFAS IN FIREFIGHTING FOAMS

perfluorononanoic acid - pfna	375-95-1	Ireland	bottled water	ng/L	<0.15	1
perfluorooctane sulfonate - pfos	1763-23-1	France	bottled water	ng/L	20.61	1
perfluorohexanoic acid - pfhxa	307-24-4	France	bottled water	ng/L	6.30	1
perfluoroheptanoic acid - pfhpa	375-85-9	France	bottled water	ng/L	22	1
perfluorooctanoic acid - pfoa	335-67-1	France	bottled water	ng/L	13	1
perfluorodecanoic acid - pfda	335-76-2	France	bottled water	ng/L	12	1
perfluorobutanesulfonate - pfbs	375-73-5	France	bottled water	ng/L	6.8	1
PFTeA		France	bottled water	ng/L	18	1
PFDS		France	bottled water	ng/L	9.1	1
PFHxDA		France	bottled water	ng/L	2.6	1
perfluorobutanesulfonate - pfbs	375-73-5	Italy	bottled water	ng/L	5	1
perfluorobutanoic acid - pfba	375-22-4	Italy	bottled water	ng/L	10 14	1
perfluorodecanoic acid - pfda	335-76-2	Italy	bottled water	ng/L	0.5	1
perfluorododecanoic acid - pfdoa	307-55-1	Italy	bottled water	ng/L	1 3.3	1
perfluoroheptanoic acid - pfhpa	375-85-9	Italy	bottled water	ng/L	2.5	1
perfluorohexane sulfonate - pfhxs	355-46-4	Italy	bottled water	ng/L	10	1
perfluorohexanoic acid - pfhxa	307-24-4	Italy	bottled water	ng/L	0.5	1
perfluorononanoic acid - pfna	375-95-1	Italy	bottled water	ng/L	0.5	1
perfluoro-n-undecanoic acid - pfuna	2058-94-8	Italy	bottled water	ng/L	0.5	1
perfluorooctane sulfonate - pfos	1763-23-1	Italy	bottled water	ng/L	5	1
perfluorooctanoic acid - pfoa	335-67-1	Italy	bottled water	ng/L	1.5	1
perfluoropentanoic acid - pfpea	2706-90-3	Italy	bottled water	ng/L	2	1
perfluorooctane sulfonate - pfos	1763-23-1	Korea	bottled water	ng/L	0.064	1
perfluorooctanoic acid - pfoa	335-67-1	Korea	bottled water	ng/L	0.158	1
perfluorononanoic acid - pfna	375-95-1	Korea	bottled water	ng/L	0.04	1

ANNEX XV RESTRICTION REPORT – PFAS IN FIREFIGHTING FOAMS

perfluorodecanoic acid - pfd	335-76-2	Korea	bottled water	ng/L	0.014	1	
perfluoro-n-undecanoic acid - pfuna	2058-94-8	Korea	bottled water	ng/L	0.082	1	
perfluorobutanoic acid - pfba	375-22-4	Korea	bottled water	ng/L	0.039	1	
perfluoropentanoic acid - pfpea	2706-90-3	Korea	bottled water	ng/L	0.084	1	
perfluorobutanesulfonate - pfbs	375-73-5	Spain	bottled water	ng/L	11.00	1	
perfluorodecanoic acid - pfd	335-76-2	Spain	bottled water	ng/L	18.00	1	
perfluoroheptanoic acid - pfhpa	375-85-9	Spain	bottled water	ng/L	<0,23	19.00	2
perfluorohexanoic acid - pfhxa	307-24-4	Spain	bottled water	ng/L	<0,23	36.00	2
perfluorononanoic acid - pfna	375-95-1	Spain	bottled water	ng/L	19.00	1	
perfluorooctane sulfonate - pfos	1763-23-1	Spain	bottled water	ng/L	<0,04	40.00	2
perfluorooctanoic acid - pfoa	335-67-1	Spain	bottled water	ng/L	14.00	1	

* the presented data originates from: (Kaboré et al., 2018, Boone et al., 2019, Domingo, 2012, Eriksson et al., 2013, Eschauzier et al., 2012, Eschauzier et al., 2013a, Essumang et al., 2017, Haug et al., 2010, Kunacheva et al., 2012, Llorca et al., 2012a, Schwanz et al., 2016, Shiwaku et al., 2016, Thompson et al., 2011, Brandsma et al., 2019, Gebbink et al., 2017, Harrad et al., 2019, Heo et al., 2014).

10.2.8. Conclusion

PFASs are present in soils, ground- and freshwater across the world. Concerning PFCA and PFSA, the longer-chained homologues groups contribute the least to total PFASs concentration in surface waters and groundwater. Rivers and streams are the most commonly studied aquatic systems and, in most cases, the most contaminated. PFAS concentrations in soil range up to ppm levels at contaminated sites. Soil can be seen as a global reservoir for PFAS contamination and human exposure via drinking water or food. For instance, PFASs in agricultural soils are a potential point of entry into the food web via crops. PFASs are retained at high concentrations in the vadose zone where they eventually can reach groundwater which is a potential source for drinking water.

10.3. Sewage treatment plant

10.3.1. Wastewater influents and effluents

A recent review by Lenka et al. (2021)) compiled information on global wastewater influents and effluents, which represented the basis of this section. Similar to other matrices, most information was available for PFAAs with concentrations in influents up to 1,000 ng L⁻¹ and 15-1,500 ng L⁻¹ in effluents, whereas information on precursors and ultra-short-chain PFASs in wastewater treatment plants (WWTPs) are mainly missing (Lenka et al., 2021). Further information on PFAS concentrations in wastewater influents and effluents was compiled in Table 23 and Table 24. In general, the majority of studies

demonstrates a poor removal of most PFASs and WWTPs had generally higher concentrations of PFASs after wastewater treatment in their effluents (Lenka et al., 2021). For PFCAs, the sorption is expected to increase with carbon chain length. PFCAs with less than 10 carbon are expected to be present in treated wastewater, whereas longer-chained PFCAs (and PFOS) are expected to sorb on sewage sludge (Arvaniti et al., 2014). In Spain, Campo et al. (2014)) detected 15 out of 21 PFAAs in both influents and effluents during 2010 and 2011 with PFBA, PFNA, PFPeA, PFOS and PFBS being most frequent. The elimination ranged from -557% (PFNA) to +100% (PFPeA, PFUdA) for PFCAs and from 0% (PFBS, PFHxS, PFHpS) to 100% (PFOS) for PFSAs. The fact that monitoring studies generally report higher PFAS concentrations in effluents (vs. influents) was suggested to be related to PFAA formation by precursors (precursors not generally monitored by targeted analyses while PFAAs are), whereas lower concentrations (especially of longer chained PFCAs and PFOS) most likely reflect sorption to sludge (Arvaniti et al., 2014, Campo et al., 2014). As a consequence, effluents of WWTP are frequently regarded as point sources for PFAS contamination. However, atmospheric deposition and matrix effects (effluents have lower background matrix) might contribute to differences between influents and effluence as well (Campo et al., 2014, Lenka et al., 2021). Sources of PFAAs for WWTPs were mainly associates to industrial wastes, which can lead to high concentrations of WWTPs in the vicinity of industrial sites (Lenka et al., 2021). For example, Dauchy et al. (2017a)) investigated 51 PFASs in wastewater near a fluorochemical plant in France and demonstrated that the WWTP released considerable amounts of PFASs into the receiving rivers. Dauchy et al. (2017a)) concluded that especially unidentified less hydrophobic PFASs are released back to the wastewater stream. In wastewater influents, short-chain PFCAs (C₄-C₈), especially PFOA and PFHxA, are most frequently detected (Lenka et al., 2021). For PFOA, concentrations seem to level-off after 2015, which is expected to be related to regulatory efforts (Lenka et al., 2021). For PFHxA, comparably high concentrations were found near an industrial site as demonstrated in Dauchy et al. (2017a)). Short-chained PFCAs were suggested to be increasingly used on a global scale to compensate for already regulated substances, which has the potential to result in considerable concentrations in the environment (Lenka et al., 2021). Among PFSAs, especially C₄-C₉ are frequently detected in WWTPs. Similar to PFCAs, shorter-chained alternatives such as PFBS are frequently detected as a consequence of PFOS regulations (Lenka et al., 2021). Interestingly, precursors -PFASs show in contrast to PFAAs decreasing concentrations from influent to effluent, which might be related to their transformation into other PFASs (Lenka et al., 2021). Especially ultra-short PFASs are suspected to represent an important part of the PFAS contamination in the effluents of WWTPs, due to the transformation of precursors containing short perfluorinated moieties into the corresponding arrowhead PFASs (Lenka et al., 2021). However, no analytical techniques are currently available for many precursors and ultra-short PFASs which limits the assessment of the total PFAS -load released by wastewater effluents. Taken together, long-chain PFASs tend to adsorb to sewage sludge, whereas short-chain PFASs are more mobile and presumably increasingly formed from precursors during wastewater treatment. In general, concentrations of most PFASs are higher in wastewater effluents, which can result in considerable releases into the environment. Future studies are urgently needed to address the knowledge gap on precursors and ultra-short-chain mobile PFASs as they are assumed to considerably contribute to the PFAS load released via wastewater effluents.

ANNEX XV RESTRICTION REPORT – PFAS IN FIREFIGHTING FOAMS

Table 23. Collection of the levels detected in wastewater influents.

Compound name	CAS No	Unit	Arithmetic mean	Min	Max	Country	Pooled or individual samples	# samples	Year of sampling	Matrix (including remarks)	Source
N-EtFOSA	4151-50-2	ng/l		n.d.	n.d.	Austria	collective sample (one sample was analysed, the sample was a collective sample sampled over a defined time period)	2	2017/2018	combined wastewater canal water	Bundesministerium für Landwirtschaft (2020)
PFOSA	754-91-6	ng/l		n.d.	n.d.	Austria	collective sample (one sample was analysed, the sample was a collective sample sampled over a defined time period)	2	2017/2018	combined wastewater canal water	
PFDA	335-76-2	ng/l		n.d.	1.3	Austria	collective sample (one sample was analysed, the sample was a collective sample sampled over a defined time period)	2	2017/2018	combined wastewater canal water	
PFDoDA	307-55-1	ng/l		n.d.	n.d.	Austria	collective sample (one sample was analysed, the sample was a collective sample sampled over a defined time period)	2	2017/2018	combined wastewater canal water	
PFDS	39108-34-4	ng/l		n.d.	n.d.	Austria	collective sample (one sample was analysed, the sample was a collective sample sampled over a defined time period)	2	2017/2018	combined wastewater canal water	
PFHpA	375-85-9	ng/l		n.d.	1.8	Austria	collective sample (one sample was analysed, the sample was a collective sample sampled over a defined time period)	2	2017/2018	combined wastewater canal water	
PFHpS	375-92-8	ng/l		n.d.	n.d.	Austria	collective sample (one sample was analysed, the sample was a collective sample sampled over a defined time period)	2	2017/2018	combined wastewater canal water	

ANNEX XV RESTRICTION REPORT – PFAS IN FIREFIGHTING FOAMS

PFHxA	307-24-4	ng/l		n.d.	< LOQ	Austria	collective sample (one sample was analysed, the sample was a collective sample sampled over a defined time period)	2	2017/2018	combined wastewater canal water
PFHxS	355-46-4	ng/l		n.d.	n.d.	Austria	collective sample (one sample was analysed, the sample was a collective sample sampled over a defined time period)	2	2017/2018	combined wastewater canal water
PFNA	375-95-1	ng/l		n.d.	< LOQ	Austria	collective sample (one sample was analysed, the sample was a collective sample sampled over a defined time period)	2	2017/2018	combined wastewater canal water
PFOA	335-67-1	ng/l		< LOQ	2.4	Austria	collective sample (one sample was analysed, the sample was a collective sample sampled over a defined time period)	2	2017/2018	combined wastewater canal water
PFOS	1763-23-1	ng/l		< LOQ	1.4	Austria	collective sample (one sample was analysed, the sample was a collective sample sampled over a defined time period)	2	2017/2018	combined wastewater canal water
PFUnDA	2058-94-8	ng/l		n.d.	n.d.	Austria	collective sample (one sample was analysed, the sample was a collective sample sampled over a defined time period)	2	2017/2018	combined wastewater canal water
N-EtFOSA	4151-50-2	ng/l		n.d.	n.d.	Austria	collective sample (one sample was analysed, the sample was a collective sample sampled over a defined time period)	3	2017/2018	deposition
PFOSA	754-91-6	ng/l		n.d.	< LOQ	Austria	collective sample (one sample was analysed, the sample was a collective sample sampled over a defined time period)	5	2017/2018	deposition

ANNEX XV RESTRICTION REPORT – PFAS IN FIREFIGHTING FOAMS

PFDA	335-76-2	ng/l		n.d.	< LOQ	Austria	collective sample (one sample was analysed, the sample was a collective sample sampled over a defined time period)	5	2017/2018	deposition
PFDoDA	307-55-1	ng/l		n.d.	n.d.	Austria	collective sample (one sample was analysed, the sample was a collective sample sampled over a defined time period)	5	2017/2018	deposition
PFDS	39108-34-4	ng/l		n.d.	n.d.	Austria	collective sample (one sample was analysed, the sample was a collective sample sampled over a defined time period)	5	2017/2018	deposition
PFHpA	375-85-9	ng/l		< LOQ	< LOQ	Austria	collective sample (one sample was analysed, the sample was a collective sample sampled over a defined time period)	5	2017/2018	deposition
PFHpS	375-92-8	ng/l		n.d.	n.d.	Austria	collective sample (one sample was analysed, the sample was a collective sample sampled over a defined time period)	5	2017/2018	deposition
PFHxA	307-24-4	ng/l		n.d.	1.5	Austria	collective sample (one sample was analysed, the sample was a collective sample sampled over a defined time period)	5	2017/2018	deposition
PFHxS	355-46-4	ng/l		n.d.	n.d.	Austria	collective sample (one sample was analysed, the sample was a collective sample sampled over a defined time period)	5	2017/2018	deposition
PFNA	375-95-1	ng/l		n.d.	< LOQ	Austria	collective sample (one sample was analysed, the sample was a collective sample sampled over a defined time period)	5	2017/2018	deposition

ANNEX XV RESTRICTION REPORT – PFAS IN FIREFIGHTING FOAMS

PFOA	335-67-1	ng/l		n.d.	1.8	Austria	collective sample (one sample was analysed, the sample was a collective sample sampled over a defined time period)	5	2017/2018	deposition
PFOS	1763-23-1	ng/l		n.d.	n.d.	Austria	collective sample (one sample was analysed, the sample was a collective sample sampled over a defined time period)	5	2017/2018	deposition
PFUnDA	2058-94-8	ng/l		n.d.	n.d.	Austria	collective sample (one sample was analysed, the sample was a collective sample sampled over a defined time period)	5	2017/2018	deposition
N-EtFOSA	4151-50-2	ng/l		n.d.	n.d.	Austria	collective sample (one sample was analysed, the sample was a collective sample sampled over a defined time period)	1	2018	dry weather run-off
PFOSA	754-91-6	ng/l		n.d.	n.d.	Austria	collective sample (one sample was analysed, the sample was a collective sample sampled over a defined time period)	2	2018	dry weather run-off
PFDA	335-76-2	ng/l		n.d.	n.d.	Austria	collective sample (one sample was analysed, the sample was a collective sample sampled over a defined time period)	2	2018	dry weather run-off
PFDoDA	307-55-1	ng/l		n.d.	n.d.	Austria	collective sample (one sample was analysed, the sample was a collective sample sampled over a defined time period)	2	2018	dry weather run-off
PFDS	39108-34-4	ng/l		n.d.	n.d.	Austria	collective sample (one sample was analysed, the sample was a collective sample sampled over a defined time period)	2	2018	dry weather run-off

ANNEX XV RESTRICTION REPORT – PFAS IN FIREFIGHTING FOAMS

PFHpA	375-85-9	ng/l		n.d.	n.d.	Austria	collective sample (one sample was analysed, the sample was a collective sample sampled over a defined time period)	1	2018	dry weather run-off
PFHpS	375-92-8	ng/l		n.d.	n.d.	Austria	collective sample (one sample was analysed, the sample was a collective sample sampled over a defined time period)	2	2018	dry weather run-off
PFHxA	307-24-4	ng/l		< LOQ	< LOQ	Austria	collective sample (one sample was analysed, the sample was a collective sample sampled over a defined time period)	1	2018	dry weather run-off
PFHxS	355-46-4	ng/l		n.d.	n.d.	Austria	collective sample (one sample was analysed, the sample was a collective sample sampled over a defined time period)	2	2018	dry weather run-off
PFNA	375-95-1	ng/l		n.d.	n.d.	Austria	collective sample (one sample was analysed, the sample was a collective sample sampled over a defined time period)	2	2018	dry weather run-off
PFOS	1763-23-1	ng/l		n.d.	n.d.	Austria	collective sample (one sample was analysed, the sample was a collective sample sampled over a defined time period)	2	2018	dry weather run-off
PFUnDA	2058-94-8	ng/l		n.d.	n.d.	Austria	collective sample (one sample was analysed, the sample was a collective sample sampled over a defined time period)	2	2018	dry weather run-off
PFOA	335-67-1	ng/l		1.7	2.2	Austria	collective sample (one sample was analysed, the sample was a collective sample sampled over a defined time period)	2	2018	dry weather run-off

ANNEX XV RESTRICTION REPORT – PFAS IN FIREFIGHTING FOAMS

N-EtFOSA	4151-50-2	ng/l		n.d.	n.d.	Austria	collective sample (one sample was analysed, the sample was a collective sample sampled over a defined time period)	8	2017/2018	run-off rainwater canal water
PFOSA	754-91-6	ng/l		n.d.	< LOQ	Austria	collective sample (one sample was analysed, the sample was a collective sample sampled over a defined time period)	8	2017/2018	run-off rainwater canal water
PFDA	335-76-2	ng/l		n.d.	2.4	Austria	collective sample (one sample was analysed, the sample was a collective sample sampled over a defined time period)	8	2017/2018	run-off rainwater canal water
PFDoDA	307-55-1	ng/l		n.d.	< LOQ	Austria	collective sample (one sample was analysed, the sample was a collective sample sampled over a defined time period)	8	2017/2018	run-off rainwater canal water
PFDS	39108-34-4	ng/l		n.d.	n.d.	Austria	collective sample (one sample was analysed, the sample was a collective sample sampled over a defined time period)	8	2017/2018	run-off rainwater canal water
PFHpA	375-85-9	ng/l		n.d.	4.5	Austria	collective sample (one sample was analysed, the sample was a collective sample sampled over a defined time period)	8	2017/2018	run-off rainwater canal water
PFHpS	375-92-8	ng/l		n.d.	n.d.	Austria	collective sample (one sample was analysed, the sample was a collective sample sampled over a defined time period)	8	2017/2018	run-off rainwater canal water
PFHxA	307-24-4	ng/l		n.d.	12	Austria	collective sample (one sample was analysed, the sample was a collective sample sampled over a defined time period)	8	2017/2018	run-off rainwater canal water

ANNEX XV RESTRICTION REPORT – PFAS IN FIREFIGHTING FOAMS

PFHxS	355-46-4	ng/l		n.d.	n.d.	Austria	collective sample (one sample was analysed, the sample was a collective sample sampled over a defined time period)	8	2017/2018	run-off rainwater canal water
PFNA	375-95-1	ng/l		n.d.	1.8	Austria	collective sample (one sample was analysed, the sample was a collective sample sampled over a defined time period)	8	2017/2018	run-off rainwater canal water
PFOA	335-67-1	ng/l		1.1	5.8	Austria	collective sample (one sample was analysed, the sample was a collective sample sampled over a defined time period)	8	2017/2018	run-off rainwater canal water
PFOS	1763-23-1	ng/l		n.d.	2.5	Austria	collective sample (one sample was analysed, the sample was a collective sample sampled over a defined time period)	8	2017/2018	run-off rainwater canal water
PFUnDA	2058-94-8	ng/l		n.d.	< LOQ	Austria	collective sample (one sample was analysed, the sample was a collective sample sampled over a defined time period)	8	2017/2018	run-off rainwater canal water
N-EtFOSA	4151-50-2	ng/l		n.d.	n.d.	Austria	collective sample (one sample was analysed, the sample was a collective sample sampled over a defined time period)	2	2017/2018	street wastewater canal water
PFOSA	754-91-6	ng/l		n.d.	n.d.	Austria	collective sample (one sample was analysed, the sample was a collective sample sampled over a defined time period)	2	2017/2018	street wastewater canal water
PFDoDA	307-55-1	ng/l		n.d.	n.d.	Austria	collective sample (one sample was analysed, the sample was a collective sample sampled over a defined time period)	2	2017/2018	street wastewater canal water

ANNEX XV RESTRICTION REPORT – PFAS IN FIREFIGHTING FOAMS

PFDS	3910 8-34- 4	ng/l		n.d.	n.d.	Austria	collective sample (one sample was analysed, the sample was a collective sample sampled over a defined time period)	2	2017/2018	street wastewater canal water
PFHpS	375- 92-8	ng/l		n.d.	n.d.	Austria	collective sample (one sample was analysed, the sample was a collective sample sampled over a defined time period)	2	2017/2018	street wastewater canal water
PFHxS	355- 46-4	ng/l		n.d.	n.d.	Austria	collective sample (one sample was analysed, the sample was a collective sample sampled over a defined time period)	2	2017/2018	street wastewater canal water
PFUnDA	2058- 94-8	ng/l		n.d.	n.d.	Austria	collective sample (one sample was analysed, the sample was a collective sample sampled over a defined time period)	2	2017/2018	street wastewater canal water
PFDA	335- 76-2	ng/l		n.d.	< LOQ	Austria	collective sample (one sample was analysed, the sample was a collective sample sampled over a defined time period)	2	2017/2018	street wastewater canal water
PFHpA	375- 85-9	ng/l		n.d.	2.1	Austria	collective sample (one sample was analysed, the sample was a collective sample sampled over a defined time period)	2	2017/2018	street wastewater canal water
PFHxA	307- 24-4	ng/l		n.d.	1.7	Austria	collective sample (one sample was analysed, the sample was a collective sample sampled over a defined time period)	2	2017/2018	street wastewater canal water
PFNA	375- 95-1	ng/l		n.d.	< LOQ	Austria	collective sample (one sample was analysed, the sample was a collective sample sampled over a defined time period)	2	2017/2018	street wastewater canal water

ANNEX XV RESTRICTION REPORT – PFAS IN FIREFIGHTING FOAMS

PFOA	335-67-1	ng/l		< LOQ	1.4	Austria	collective sample (one sample was analysed, the sample was a collective sample sampled over a defined time period)	2	2017/2018	street wastewater canal water	
PFOS	1763-23-1	ng/l		n.d.	< LOQ	Austria	collective sample (one sample was analysed, the sample was a collective sample sampled over a defined time period)	2	2017/2018	street wastewater canal water	
N-EtFOSA	4151-50-2	ng/l		n.d.	n.d.	Austria	individual samples	3	2015	deposition	Amt der Vorarlberger Landesregierung (2016)
PFDA	335-76-2	ng/l		< LOQ	1.3	Austria	individual samples	3	2015	deposition	
PFDS	39108-34-4	ng/l		n.d.	n.d.	Austria	individual samples	3	2015	deposition	
PFDoDA	307-55-1	ng/l		n.d.	< LOQ	Austria	individual samples	3	2015	deposition	
PFHpA	375-85-9	ng/l		n.d.	n.d.	Austria	individual samples	3	2015	deposition	
PFHpS	375-92-8	ng/l		n.d.	n.d.	Austria	individual samples	3	2015	deposition	
PFHxA	307-24-4	ng/l		n.d.	n.d.	Austria	individual samples	3	2015	deposition	
PFHxS	355-46-4	ng/l		n.d.	n.d.	Austria	individual samples	3	2015	deposition	
PFNA	375-95-1	ng/l		< LOQ	0.0013	Austria	individual samples	3	2015	deposition	
PFOA	335-67-1	ng/l		1.2	0.0025	Austria	individual samples	3	2015	deposition	
PFOSA	754-91-6	ng/l		n.d.	n.d.	Austria	individual samples	3	2015	deposition	
PFOS	1763-23-1	ng/l		n.d.	0.0017	Austria	individual samples	3	2015	deposition	

ANNEX XV RESTRICTION REPORT – PFAS IN FIREFIGHTING FOAMS

PFUnDA	2058-94-8	ng/l		n.d.	< LOQ	Austria	individual samples	3	2015	deposition	
PFHxA	307-24-4	ng/l		n.d.	16.00	Austria	pooled samples	34	2016	wastewater (urban)	Bundesministerium für Land- und Forstwirtschaft. Umwelt und Wasserwirtschaft (2017)
PFHpS	375-92-8	ng/l		n.d.	4.70	Austria	pooled samples	34	2016	wastewater (urban)	
PFOA	335-67-1	ng/l		1.1000	46.00	Austria	pooled samples	34	2016	wastewater (urban)	
PFNA	375-95-1	ng/l		n.d.	1.90	Austria	pooled samples	34	2016	wastewater (urban)	
PFDA	335-76-2	ng/l		n.d.	7.50	Austria	pooled samples	34	2016	wastewater (urban)	
PFUnDA	2058-94-8	ng/l		n.d.	1.40	Austria	pooled samples	34	2016	wastewater (urban)	
PFDoDA	307-55-1	ng/l		n.d.	n.d.	Austria	pooled samples	34	2016	wastewater (urban)	
PFHxS	355-46-4	ng/l		n.d.	0.012	Austria	pooled samples	34	2016	wastewater (urban)	
PFHpA	375-85-9	ng/l		n.d.	2.0	Austria	pooled samples	34	2016	wastewater (urban)	
PFOS	1763-23-1	ng/l		< LOQ	120.0	Austria	pooled samples	34	2016	wastewater (urban)	
PFDS	39108-34-4	ng/l		n.d.	n.d.	Austria	pooled samples	34	2016	wastewater (urban)	
N-EtFOSA	4151-50-2	ng/l		n.d.	n.d.	Austria	pooled samples	34	2016	wastewater (urban)	
PFOSA	754-91-6	ng/l		n.d.	< LOQ	Austria	pooled samples	34	2016	wastewater (urban)	
PFOS	1763-23-1	ng/l		19	840	Austria	individual samples	8	2015	landfill leachate	

ANNEX XV RESTRICTION REPORT – PFAS IN FIREFIGHTING FOAMS

											Wasserwirtschaft (2016)
N-EtFOSA	4151-50-2	ng/l		n.d.	n.d.	Austria	individual samples	3	2016	wasterwater influent	Amt der Vorarlberger Landesregierung (2017)
PFBA	375-22-4	ng/l		n.d.	28	Austria	individual samples	3	2016	wasterwater influent	
PFBS	375-73-5	ng/l		n.d.	n.d.	Austria	individual samples	3	2016	wasterwater influent	
PFOSA	754-91-6	ng/l		n.d.	n.d.	Austria	individual samples	3	2016	wasterwater influent	
PFDA	335-76-2	ng/l		n.d.	< LOQ	Austria	individual samples	3	2016	wasterwater influent	
PFDS	39108-34-4	ng/l		n.d.	n.d.	Austria	individual samples	3	2016	wasterwater influent	
PFDoDA	307-55-1	ng/l		n.d.	n.d.	Austria	individual samples	3	2016	wasterwater influent	
PFHpS	375-92-8	ng/l		n.d.	1.4	Austria	individual samples	3	2016	wasterwater influent	
PFHpA	375-85-9	ng/l		n.d.	n.d.	Austria	individual samples	3	2016	wasterwater influent	
PFHxA	307-24-4	ng/l		2	5.9	Austria	individual samples	3	2016	wasterwater influent	
PFHxS	355-46-4	ng/l		n.d.	1.4	Austria	individual samples	3	2016	wasterwater influent	
PFNA	375-95-1	ng/l		n.d.	2.2	Austria	individual samples	3	2016	wasterwater influent	
PFOA	335-67-1	ng/l		2.4	8.2	Austria	individual samples	3	2016	wasterwater influent	
PFOS	1763-23-1	ng/l		< LOQ	8.6	Austria	individual samples	3	2016	wasterwater influent	
PFUnDA	2058-94-8	ng/l		n.d.	n.d.	Austria	individual samples	3	2016	wasterwater influent	

ANNEX XV RESTRICTION REPORT – PFAS IN FIREFIGHTING FOAMS

PFBA	375-22-4	ng/l	20.5			Spain	pooled samples	15	2010	wastewater influent	Campo et al. (2014)
PFPeA	2706-90-3	ng/l	7.76			Spain	pooled samples	15	2010	wastewater influent	
PFHxA	307-24-4	ng/l	1870			Spain	pooled samples	15	2010	wastewater influent	
PFHpA	375-85-9	ng/l	14.3			Spain	pooled samples	15	2010	wastewater influent	
PFOA	335-67-1	ng/l	19			Spain	pooled samples	15	2010	wastewater influent	
PFNA	375-95-1	ng/l	8.73			Spain	pooled samples	15	2010	wastewater influent	
PFDA	335-76-2	ng/l	36.7			Spain	pooled samples	15	2010	wastewater influent	
PFUdA	2058-94-8	ng/l	4.58			Spain	pooled samples	15	2010	wastewater influent	
PFDoA	307-55-1	ng/l	1.62			Spain	pooled samples	15	2010	wastewater influent	
PFTTrDA	7262-9-94-8	ng/l	6.8			Spain	pooled samples	15	2010	wastewater influent	
PFTeDA	376-06-7	ng/l	n.d.			Spain	pooled samples	15	2010	wastewater influent	
PFHxDA	6790-5-19-5	ng/l	n.d.			Spain	pooled samples	15	2010	wastewater influent	
PFODA	1651-7-11-6	ng/l	n.d.			Spain	pooled samples	15	2010	wastewater influent	
PFBS	375-73-5	ng/l	12			Spain	pooled samples	15	2010	wastewater influent	
PFHxS	355-46-4	ng/l	15.5			Spain	pooled samples	15	2010	wastewater influent	

ANNEX XV RESTRICTION REPORT – PFAS IN FIREFIGHTING FOAMS

PFHpS	375-92-8	ng/l	14.6			Spain	pooled samples	15	2010	wasterwater influent
PFOS	1763-23-1	ng/l	118			Spain	pooled samples	15	2010	wasterwater influent
PFNS	68259-12-1	ng/l	3.28			Spain	pooled samples	15	2010	wasterwater influent
PFDS	39108-34-4	ng/l	n.d.			Spain	pooled samples	15	2010	wasterwater influent
PFOSA	754-91-6	ng/l	n.d.			Spain	pooled samples	15	2010	wasterwater influent
PFBA	375-22-4	ng/l	53.7			Spain	pooled samples	16	2011	wasterwater influent
PFPeA	2706-90-3	ng/l	9.35			Spain	pooled samples	16	2011	wasterwater influent
PFHxA	307-24-4	ng/l	1.07			Spain	pooled samples	16	2011	wasterwater influent
PFHpA	375-85-9	ng/l	13			Spain	pooled samples	16	2011	wasterwater influent
PFOA	335-67-1	ng/l	22.4			Spain	pooled samples	16	2011	wasterwater influent
PFNA	375-95-1	ng/l	21.2			Spain	pooled samples	16	2011	wasterwater influent
PFDA	335-76-2	ng/l	0.58			Spain	pooled samples	16	2011	wasterwater influent
PFUdA	2058-94-8	ng/l	12.9			Spain	pooled samples	16	2011	wasterwater influent
PFDoA	307-55-1	ng/l	13.8			Spain	pooled samples	16	2011	wasterwater influent
PFTTrDA	72629-94-8	ng/l	13.2			Spain	pooled samples	16	2011	wasterwater influent

ANNEX XV RESTRICTION REPORT – PFAS IN FIREFIGHTING FOAMS

PFTeDA	376-06-7	ng/l	0.02			Spain	pooled samples	16	2011	wasterwater influent	
PFHxDA	67905-19-5	ng/l	0.04			Spain	pooled samples	16	2011	wasterwater influent	
PFODA	16517-11-6	ng/l	300			Spain	pooled samples	16	2011	wasterwater influent	
PFBS	375-73-5	ng/l	19.1			Spain	pooled samples	16	2011	wasterwater influent	
PFHxS	355-46-4	ng/l	41.9			Spain	pooled samples	16	2011	wasterwater influent	
PFHpS	375-92-8	ng/l	8.83			Spain	pooled samples	16	2011	wasterwater influent	
PFOS	1763-23-1	ng/l	78.1			Spain	pooled samples	16	2011	wasterwater influent	
PFNS	68259-12-1	ng/l	5.62			Spain	pooled samples	16	2011	wasterwater influent	
PFDS	39108-34-4	ng/l	n.d.			Spain	pooled samples	16	2011	wasterwater influent	
PFOSA	754-91-6	ng/l	0.2			Spain	pooled samples	16	2011	wasterwater influent	
PFBS	375-73-5	ng/l	7			Greece	pooled samples (triplicates)	3	2014	wastewater influent	Gago-Ferrero et al. (2020)
PFDA	335-76-2	ng/l	50			Greece	pooled samples (triplicates)	3	2014	wastewater influent	
PFHpA	375-85-9	ng/l	6			Greece	pooled samples (triplicates)	3	2014	wastewater influent	
PFHps	335-77-3	ng/l	0.7			Greece	pooled samples (triplicates)	3	2014	wastewater influent	

ANNEX XV RESTRICTION REPORT – PFAS IN FIREFIGHTING FOAMS

PFHxA	307-24-4	ng/l	2			Greece	pooled samples (triplicates)	3	2014	wastewater influent	
PFHxS	355-46-4	ng/l	5			Greece	pooled samples (triplicates)	3	2014	wastewater influent	
PFNA	375-95-1	ng/l	10			Greece	pooled samples (triplicates)	3	2014	wastewater influent	
PFOA	2395-00-8	ng/l	8			Greece	pooled samples (triplicates)	3	2014	wastewater influent	
PFOS	1763-23-1	ng/l	30			Greece	pooled samples (triplicates)	3	2014	wastewater influent	
PFPeA	2706-90-3	ng/l	2			Greece	pooled samples (triplicates)	3	2014	wastewater influent	
PFUnA	2058-94-8	ng/l	n.d.			Greece	pooled samples (triplicates)	3	2014	wastewater influent	
PFBA	375-22-4	ng/l	496			France	individual samples	1	2015	industrial wastewater influent	Gomez-Ruiz et al. (2017)
PFPeA	2706-90-3	ng/l	3154			France	individual samples	1	2015	industrial wastewater influent	
PFHxA	307-24-4	ng/l	5291			France	individual samples	1	2015	industrial wastewater influent	
PFHpA	375-85-9	ng/l	2793			France	individual samples	1	2015	industrial wastewater influent	
PFOA	335-67-1	ng/l	449			France	individual samples	1	2015	industrial wastewater influent	
6:2 FTSA	27619-97-2	ng/l	242 496			France	individual samples	1	2015	industrial wastewater influent	

ANNEX XV RESTRICTION REPORT – PFAS IN FIREFIGHTING FOAMS

8:2 FTSA	3910 8-34- 4	ng/l	874			France	individual samples	1	2015	industrial wastewater influent	Eriksson et al. (2017)
6:2 FTCA		ng/l	328			France	individual samples	1	2015	industrial wastewater influent	
6:2 FTAB		ng/l	1 111 000			France	individual samples	1	2015	industrial wastewater influent	
ΣPFCA		ng/l	19			Sweden	individual samples		2015	wastewater influent	
ΣPFSA		ng/l	4.6			Sweden	individual samples		2015	wastewater influent	
ΣFTSA		ng/l	2.9			Sweden	individual samples		2015	wastewater influent	
ΣmonoP AP		ng/l	<LOD			Sweden	individual samples		2015	wastewater influent	
ΣdiPAP		ng/l	58			Sweden	individual samples		2015	wastewater influent	
ΣPFPA		ng/l	11			Sweden	individual samples		2015	wastewater influent	
ΣPFPiA		ng/l	0.6			Sweden	individual samples		2015	wastewater influent	
ΣPFCA		ng/l	23			Sweden	individual samples		2015	wastewater influent	
ΣPFSA		ng/l	7.2			Sweden	individual samples		2015	wastewater influent	
ΣFTSA		ng/l	6			Sweden	individual samples		2015	wastewater influent	
ΣmonoP AP		ng/l	<LOD			Sweden	individual samples		2015	wastewater influent	
ΣdiPAP		ng/l	n.q.			Sweden	individual samples		2015	wastewater influent	

ANNEX XV RESTRICTION REPORT – PFAS IN FIREFIGHTING FOAMS

ΣPFPA		ng/l	1.8			Sweden	individual samples		2015	wastewater influent	
ΣPFPIA		ng/l	0.6			Sweden	individual samples		2015	wastewater influent	
ΣPFCA		ng/l	18			Sweden	individual samples		2015	wastewater influent	
ΣPFSA		ng/l	3.9			Sweden	individual samples		2015	wastewater influent	
ΣFTSA		ng/l	2.6			Sweden	individual samples		2015	wastewater influent	
ΣmonoP AP		ng/l	n.q.			Sweden	individual samples		2015	wastewater influent	
ΣdiPAP		ng/l	n.q.			Sweden	individual samples		2015	wastewater influent	
ΣPFPA		ng/l	20			Sweden	individual samples		2015	wastewater influent	
ΣPFPIA		ng/l	0.3			Sweden	individual samples		2015	wastewater influent	
PFBA	375-22-4	ng/l	4.8	<LOD	20.9	Spain	pooled sample	13	2016/2017	wastewater influent	Lorenzo et al. (2019)
PFPeA	2706-90-3	ng/l	2.1	<LOD	27	Spain	pooled sample	13	2016/2017	wastewater influent	
PFBS	375-73-5	ng/l	n.d.	n.d.	n.d.	Spain	pooled sample	13	2016/2017	wastewater influent	
PFHxA	307-24-4	ng/l	1.8	<LOD	23.3	Spain	pooled sample	13	2016/2017	wastewater influent	
PFHpA	375-85-9	ng/l	1.9	<LOD	7.5	Spain	pooled sample	13	2016/2017	wastewater influent	
PFHxS	355-46-4	ng/l	6.9	<LOD	51.8	Spain	pooled sample	13	2016/2017	wastewater influent	
PFHpS	375-92-8	ng/l	1.7	<LOD	22.2	Spain	pooled sample	13	2016/2017	wastewater influent	

ANNEX XV RESTRICTION REPORT – PFAS IN FIREFIGHTING FOAMS

PFOA	335-67-1	ng/l	3.4	0.04	5.9	Spain	pooled sample	13	2016/2017	wastewater influent		
PFOS	1763-23-1	ng/l	11.1	<LOD	63.1	Spain	pooled sample	13	2016/2017	wastewater influent		
PFNA	375-95-1	ng/l	n.d.	n.d.	n.d.	Spain	pooled sample	13	2016/2017	wastewater influent		
PFDA	335-76-2	ng/l	n.d.	n.d.	n.d.	Spain	pooled sample	13	2016/2017	wastewater influent		
PFDS	39108-34-4	ng/l	1.9	<LOD	12.7	Spain	pooled sample	13	2016/2017	wastewater influent		
PFUnDA	2058-94-8	ng/l	n.d.	n.d.	n.d.	Spain	pooled sample	13	2016/2017	wastewater influent		
PFDoDA	307-55-1	ng/l	3.2	<LOD	41.6	Spain	pooled sample	13	2016/2017	wastewater influent		
PFTTrDA	72629-94-8	ng/l	n.d.	n.d.	n.d.	Spain	pooled sample	13	2016/2017	wastewater influent		
PFTeDA	376-06-7	ng/l	3.2	<LOD	41.2	Spain	pooled sample	13	2016/2017	wastewater influent		
PFHxDA	67905-19-5	ng/l	n.d.	n.d.	n.d.	Spain	pooled sample	13	2016/2017	wastewater influent		
PFODA	16517-11-6	ng/l	n.d.	n.d.	n.d.	Spain	pooled sample	13	2016/2017	wastewater influent		
PFHxA	307-24-4	ng/l	5.05			Sweden	24h composite samples		2013	wastewater influent		Filipovic and Berger (2015)
PFHpA	375-85-9	ng/l	2.63			Sweden	24h composite samples		2013	wastewater influent		
PFOA	335-67-1	ng/l	4.75			Sweden	24h composite samples		2013	wastewater influent		

ANNEX XV RESTRICTION REPORT – PFAS IN FIREFIGHTING FOAMS

PFNA	375-95-1	ng/l	0.909			Sweden	24h composite samples		2013	wastewater influent
PFDA	335-76-2	ng/l	0.854			Sweden	24h composite samples		2013	wastewater influent
PFUnDA	2058-94-8	ng/l	0.274			Sweden	24h composite samples		2013	wastewater influent
PFDoDA	307-55-1	ng/l	0.36			Sweden	24h composite samples		2013	wastewater influent
PFBS	375-73-5	ng/l	1.55			Sweden	24h composite samples		2013	wastewater influent
PFHxS	355-46-4	ng/l	4.29			Sweden	24h composite samples		2013	wastewater influent
PFOS	1763-23-1	ng/l	6.98			Sweden	24h composite samples		2013	wastewater influent
PFDS	3910-8-34-4	ng/l	0.315			Sweden	24h composite samples		2013	wastewater influent
FOSA	754-91-6	ng/l	0.94			Sweden	24h composite samples		2013	wastewater influent
PFHxA	307-24-4	ng/l	6.69			Sweden	24h composite samples		2013	wastewater influent
PFHpA	375-85-9	ng/l	0.246			Sweden	24h composite samples		2013	wastewater influent
PFOA	335-67-1	ng/l	2.9			Sweden	24h composite samples		2013	wastewater influent
PFNA	375-95-1	ng/l	0.789			Sweden	24h composite samples		2013	wastewater influent
PFDA	335-76-2	ng/l	0.495			Sweden	24h composite samples		2013	wastewater influent
PFUnDA	2058-94-8	ng/l	0.448			Sweden	24h composite samples		2013	wastewater influent
PFDoDA	307-55-1	ng/l	0.264			Sweden	24h composite samples		2013	wastewater influent

ANNEX XV RESTRICTION REPORT – PFAS IN FIREFIGHTING FOAMS

PFBS	375-73-5	ng/l	0.218			Sweden	24h composite samples		2013	wastewater influent
PFHxS	355-46-4	ng/l	0.393			Sweden	24h composite samples		2013	wastewater influent
PFOS	1763-23-1	ng/l	1.76			Sweden	24h composite samples		2013	wastewater influent
PFDS	39108-34-4	ng/l	<MDL			Sweden	24h composite samples		2013	wastewater influent
FOSA	754-91-6	ng/l	0.115			Sweden	24h composite samples		2013	wastewater influent
PFHxA	307-24-4	ng/l	3.79			Sweden	24h composite samples		2013	wastewater influent
PFHpA	375-85-9	ng/l	1.76			Sweden	24h composite samples		2013	wastewater influent
PFOA	335-67-1	ng/l	3.24			Sweden	24h composite samples		2013	wastewater influent
PFNA	375-95-1	ng/l	0.754			Sweden	24h composite samples		2013	wastewater influent
PFDA	335-76-2	ng/l	0.671			Sweden	24h composite samples		2013	wastewater influent
PFUnDA	2058-94-8	ng/l	0.385			Sweden	24h composite samples		2013	wastewater influent
PFDoDA	307-55-1	ng/l	0.193			Sweden	24h composite samples		2013	wastewater influent
PFBS	375-73-5	ng/l	1.1			Sweden	24h composite samples		2013	wastewater influent
PFHxS	355-46-4	ng/l	1.52			Sweden	24h composite samples		2013	wastewater influent
PFOS	1763-23-1	ng/l	3.29			Sweden	24h composite samples		2013	wastewater influent

ANNEX XV RESTRICTION REPORT – PFAS IN FIREFIGHTING FOAMS

PFDS	3910 8-34- 4	ng/l	0.292			Sweden	24h composite samples		2013	wastewater influent	Arvaniti et al. (2012)
FOSA	754- 91-6	ng/l	0.199			Sweden	24h composite samples		2013	wastewater influent	
PFPeA	2706- 90-3	ng/l	26.7	<LOQ	106.1	Greece	24h composite samples		2009/201 0	wastewater influent	
PFHxA	307- 24-4	ng/l	1.7	<LOD	3.6	Greece	24h composite samples		2009/201 0	wastewater influent	
PFHpA	375- 85-9	ng/l	2.2	<LOD	8.6	Greece	24h composite samples		2009/201 0	wastewater influent	
PFOA	335- 67-1	ng/l	16.5	10.2	20.7	Greece	24h composite samples		2009/201 0	wastewater influent	
PFNA	375- 95-1	ng/l	1.2	<LOD	3.4	Greece	24h composite samples		2009/201 0	wastewater influent	
PFDA	335- 76-2	ng/l	1	<LOD	3.2	Greece	24h composite samples		2009/201 0	wastewater influent	
PFUdA	2058- 94-8	ng/l	2.5	<LOD	8.6	Greece	24h composite samples		2009/201 0	wastewater influent	
PFDoA	307- 55-1	ng/l	1.2	<LOD	7	Greece	24h composite samples		2009/201 0	wastewater influent	
PFTrDA	7262 9-94- 8	ng/l	1.8	<LOD	11.1	Greece	24h composite samples		2009/201 0	wastewater influent	
PFTeDA	376- 06-7	ng/l	3.1	<LOD	18.8	Greece	24h composite samples		2009/201 0	wastewater influent	
PFBS	375- 73-5	ng/l	/	<LOD	/	Greece	24h composite samples		2009/201 0	wastewater influent	
PFHxS	355- 46-4	ng/l	6	<LOD	15.7	Greece	24h composite samples		2009/201 0	wastewater influent	
PFHpS	375- 92-8	ng/l	/	<LOD	/	Greece	24h composite samples		2009/201 0	wastewater influent	

ANNEX XV RESTRICTION REPORT – PFAS IN FIREFIGHTING FOAMS

PFOS	1763-23-1	ng/l	13.4	2.4	26.3	Greece	24h composite samples		2009/2010	wastewater influent
PFDS	39108-34-4	ng/l	1.8	<LOD	11	Greece	24h composite samples		2009/2010	wastewater influent
PFOSA	754-91-6	ng/l	1.7	<LOD	9	Greece	24h composite samples		2009/2010	wastewater influent
N-MeFOSA	31506-32-8	ng/l	/	<LOD	/	Greece	24h composite samples		2009/2010	wastewater influent
N-EtFOSA	4151-50-2	ng/l	/	<LOD	/	Greece	24h composite samples		2009/2010	wastewater influent
PFPeA	2706-90-3	ng/l	24.8	8.4	52.5	Greece	24h composite samples		2009/2010	wastewater influent
PFHxA	307-24-4	ng/l	<LOQ	<LOD	<LOQ	Greece	24h composite samples		2009/2010	wastewater influent
PFHpA	375-85-9	ng/l	1.2	<LOD	5.2	Greece	24h composite samples		2009/2010	wastewater influent
PFOA	335-67-1	ng/l	4.2	<LOD	6.3	Greece	24h composite samples		2009/2010	wastewater influent
PFNA	375-95-1	ng/l	<LOQ	<LOD	<LOQ	Greece	24h composite samples		2009/2010	wastewater influent
PFDA	335-76-2	ng/l	5.6	<LOD	33.5	Greece	24h composite samples		2009/2010	wastewater influent
PFUDa	2058-94-8	ng/l	9.4	<LOD	55.2	Greece	24h composite samples		2009/2010	wastewater influent
PFDoA	307-55-1	ng/l	13.8	<LOD	82.6	Greece	24h composite samples		2009/2010	wastewater influent
PFTrDA	72629-94-8	ng/l	75.7	<LOD	453	Greece	24h composite samples		2009/2010	wastewater influent
PFTeDA	376-06-7	ng/l	/	<LOD	/	Greece	24h composite samples		2009/2010	wastewater influent

ANNEX XV RESTRICTION REPORT – PFAS IN FIREFIGHTING FOAMS

PFBS	375-73-5	ng/l	/	<LOD	/	Greece	24h composite samples		2009/2010	wastewater influent
PFHxS	355-46-4	ng/l	6.8	<LOD	20.7	Greece	24h composite samples		2009/2010	wastewater influent
PFHpS	375-92-8	ng/l	3.3	<LOD	19.6	Greece	24h composite samples		2009/2010	wastewater influent
PFOS	1763-23-1	ng/l	3.5	1	6.3	Greece	24h composite samples		2009/2010	wastewater influent
PFDS	39108-34-4	ng/l	17.9	<LOD	107.4	Greece	24h composite samples		2009/2010	wastewater influent
PFOSA	754-91-6	ng/l	2.3	<LOD	14	Greece	24h composite samples		2009/2010	wastewater influent
N-MeFOSA	31506-32-8	ng/l	/	<LOD	/	Greece	24h composite samples		2009/2010	wastewater influent
N-EtFOSA	4151-50-2	ng/l	/	<LOD	/	Greece	24h composite samples		2009/2010	wastewater influent

Table 24. Collection of the levels detected in wastewater effluents.

Compound name	CAS No	Unit	Mean	Min	Max	Country	Pooled or individual samples	# samples	Year	Matrix (including remarks)	Source
PFOA	335-67-1	µg/l		<LOQ	39	Austria	individual samples	20	2017	wastewater (industrial direct discharge)	Bundesministerium für Nachhaltigkeit und Tourismus (2019)
PFOS	1763-23-1	µg/l		<LOQ	580	Austria	individual samples	20	2017	wastewater (industrial direct discharge)	
N-EtFOSA	4151-50-2	µg/l		n.d.	n.d.	Austria	individual samples	3	2016	wastewater effluent	Amt der Vorarlberger

ANNEX XV RESTRICTION REPORT – PFAS IN FIREFIGHTING FOAMS

PFBA	375-22-4	µg /l		n.d.	530	Austria	individual samples	3	2016	wastewater effluent	Landesregierung (2017)
PFBS	375-73-5	µg /l		n.d.	n.d.	Austria	individual samples	3	2016	wastewater effluent	
PFOSA	754-91-6	µg /l		n.d.	n.d.	Austria	individual samples	3	2016	wastewater effluent	
PFDA	335-76-2	µg /l		n.d.	< LOQ	Austria	individual samples	3	2016	wastewater effluent	
PFDS	39108-34-4	µg /l		n.d.	n.d.	Austria	individual samples	3	2016	wastewater effluent	
PFDoDA	307-55-1	µg /l		n.d.	n.d.	Austria	individual samples	3	2016	wastewater effluent	
PFHpS	375-92-8	µg /l		n.d.	1.3	Austria	individual samples	3	2016	wastewater effluent	
PFHpA	375-85-9	µg /l		n.d.	n.d.	Austria	individual samples	3	2016	wastewater effluent	
PFHxA	307-24-4	µg /l		2.2	5.8	Austria	individual samples	3	2016	wastewater effluent	
PFHxS	355-46-4	µg /l		n.d.	1.4	Austria	individual samples	3	2016	wastewater effluent	
PFNA	375-95-1	µg /l		n.d.	< LOQ	Austria	individual samples	3	2016	wastewater effluent	
PFOA	335-67-1	µg /l		2.8	3	Austria	individual samples	3	2016	wastewater effluent	
PFOS	1763-23-1	µg /l		< LOQ	6.1	Austria	individual samples	3	2016	wastewater effluent	
PFUnDA	2058-94-8	µg /l		n.d.	n.d.	Austria	individual samples	3	2016	wastewater effluent	
4:2 FTS	757124-72-4	ng /L	0.35	0.15	0.54	Norway	Individual	2	2017	effluent water	to be added
6:2 FTS	27619-97-2	ng /L	1.1	0.15	2.1	Norway	Individual	2	2017	effluent water	

ANNEX XV RESTRICTION REPORT – PFAS IN FIREFIGHTING FOAMS

8:2 FTS	39108-34-4	ng/L				Norway	Individual	2	2017	effluent water
8CIPFOS		ng/L				Norway	Individual	2	2017	effluent water
N-EtFOSA	4151-50-2	ng/L				Norway	Individual	2	2017	effluent water
N-EtFOSE	1691-99-2	ng/L				Norway	Individual	2	2017	effluent water
N-EtFOSAA	2991-50-6	ng/L				Norway	Individual	2	2017	effluent water
N-MeFOSA	31506-32-8	ng/L				Norway	Individual	2	2017	effluent water
N-MeFOSE	24448-09-7	ng/L				Norway	Individual	2	2017	effluent water
N-MeFOSAA	2355-31-9	ng/L				Norway	Individual	2	2017	effluent water
PFBS	375-73-5	ng/L	3.69	3.29	4.08	Norway	Individual	2	2017	effluent water
PFDA	335-76-2	ng/L	0.585	0.51	0.66	Norway	Individual	2	2017	effluent water
PFDODA	307-55-1	ng/L				Norway	Individual	2	2017	effluent water
PFDODS	79780-39-5	ng/L				Norway	Individual	2	2017	effluent water
PFDS	335-77-3	ng/L				Norway	Individual	2	2017	effluent water
PFHpA	375-85-9	ng/L	3.12	3.01	3.22	Norway	Individual	2	2017	effluent water
PFHpS	82765-77-3	ng/L				Norway	Individual	2	2017	effluent water
PFHxA	307-24-4	ng/L	5.79	4.7	6.88	Norway	Individual	2	2017	effluent water

ANNEX XV RESTRICTION REPORT – PFAS IN FIREFIGHTING FOAMS

PFHxS	355-46-4	ng /L	0.85	0.77	0.93	Norway	Individual	2	2017	effluent water		
PFNA	375-95-1	ng /L	1.18	1.11	1.25	Norway	Individual	2	2017	effluent water		
PFNS	68259-12-1	ng /L				Norway	Individual	2	2017	effluent water		
PFOA	335-67-1	ng /L	6.4	5.6	7.2	Norway	Individual	2	2017	effluent water		
PFOS	1763-23-1	ng /L	1.97	1.67	2.26	Norway	Individual	2	2017	effluent water		
PFOSA	754-91-6	ng /L				Norway	Individual	2	2017	effluent water		
PFPA	2706-90-3	ng /L	6.55	5.52	7.58	Norway	Individual	2	2017	effluent water		
PFPS	2706-91-4	ng /L				Norway	Individual	2	2017	effluent water		
PFTeDA	376-06-7	ng /L				Norway	Individual	2	2017	effluent water		
PFTrDA	72629-94-8	ng /L				Norway	Individual	2	2017	effluent water		
PFUnDA	2058-94-8	ng /L				Norway	Individual	2	2017	effluent water		
PFBA	375-22-4	ng /l	13.4			Spain	pooled samples	15	2010	wasterwater effluent		Campo et al. (2014)
PFPeA	2706-90-3	ng /l	8.09			Spain	pooled samples	15	2010	wasterwater effluent		
PFHxA	307-24-4	ng /l	4.87			Spain	pooled samples	15	2010	wasterwater effluent		
PFHpA	375-85-9	ng /l	9.58			Spain	pooled samples	15	2010	wasterwater effluent		
PFOA	335-67-1	ng /l	16.4			Spain	pooled samples	15	2010	wasterwater effluent		

ANNEX XV RESTRICTION REPORT – PFAS IN FIREFIGHTING FOAMS

PFNA	375-95-1	ng /l	5.52			Spain	pooled samples	15	2010	wasterwater effluent
PFDA	335-76-2	ng /l	28.1			Spain	pooled samples	15	2010	wasterwater effluent
PFUdA	2058-94-8	ng /l	2.57			Spain	pooled samples	15	2010	wasterwater effluent
PFDoA	307-55-1	ng /l	0.07			Spain	pooled samples	15	2010	wasterwater effluent
PFTTrDA	72629-94-8	ng /l	5.1			Spain	pooled samples	15	2010	wasterwater effluent
PFTeDA	376-06-7	ng /l	n.d.			Spain	pooled samples	15	2010	wasterwater effluent
PFHxDA	67905-19-5	ng /l	n.d.			Spain	pooled samples	15	2010	wasterwater effluent
PFODA	16517-11-6	ng /l	n.d.			Spain	pooled samples	15	2010	wasterwater effluent
PFBS	375-73-5	ng /l	8.57			Spain	pooled samples	15	2010	wasterwater effluent
PFHxS	355-46-4	ng /l	14.1			Spain	pooled samples	15	2010	wasterwater effluent
PFHpS	375-92-8	ng /l	2.19			Spain	pooled samples	15	2010	wasterwater effluent
PFOS	1763-23-1	ng /l	76.7			Spain	pooled samples	15	2010	wasterwater effluent
PFNS	68259-12-1	ng /l	0.04			Spain	pooled samples	15	2010	wasterwater effluent
PFDS	39108-34-4	ng /l	n.d.			Spain	pooled samples	15	2010	wasterwater effluent
PFOSA	754-91-6	ng /l	n.d.			Spain	pooled samples	15	2010	wasterwater effluent
PFBA	375-22-4	ng /l	57.9			Spain	pooled samples	16	2011	wasterwater effluent

ANNEX XV RESTRICTION REPORT – PFAS IN FIREFIGHTING FOAMS

PFPeA	2706-90-3	ng/l	14.5			Spain	pooled samples	16	2011	wasterwater effluent
PFHxA	307-24-4	ng/l	17.5			Spain	pooled samples	16	2011	wasterwater effluent
PFHpA	375-85-9	ng/l	7.48			Spain	pooled samples	16	2011	wasterwater effluent
PFOA	335-67-1	ng/l	14.9			Spain	pooled samples	16	2011	wasterwater effluent
PFNA	375-95-1	ng/l	33.7			Spain	pooled samples	16	2011	wasterwater effluent
PFDA	335-76-2	ng/l	21.6			Spain	pooled samples	16	2011	wasterwater effluent
PFuDA	2058-94-8	ng/l	5.62			Spain	pooled samples	16	2011	wasterwater effluent
PFDoA	307-55-1	ng/l	13.3			Spain	pooled samples	16	2011	wasterwater effluent
PFTTrDA	72629-94-8	ng/l	0.02			Spain	pooled samples	16	2011	wasterwater effluent
PFTeDA	376-06-7	ng/l	0.02			Spain	pooled samples	16	2011	wasterwater effluent
PFHxDA	67905-19-5	ng/l	0.04			Spain	pooled samples	16	2011	wasterwater effluent
PFODA	16517-11-6	ng/l	190			Spain	pooled samples	16	2011	wasterwater effluent
PFBS	375-73-5	ng/l	57.9			Spain	pooled samples	16	2011	wasterwater effluent
PFHxS	355-46-4	ng/l	37.7			Spain	pooled samples	16	2011	wasterwater effluent
PFHpS	375-92-8	ng/l	2.91			Spain	pooled samples	16	2011	wasterwater effluent
PFOS	1763-23-1	ng/l	91			Spain	pooled samples	16	2011	wasterwater effluent

ANNEX XV RESTRICTION REPORT – PFAS IN FIREFIGHTING FOAMS

PFNS	68259-12-1	ng/l	0.04			Spain	pooled samples	16	2011	wasterwater effluent	Dauchy et al. (2019)
PFDS	39108-34-4	ng/l	n.d.			Spain	pooled samples	16	2011	wasterwater effluent	
PFOSA	754-91-6	ng/l	0.2			Spain	pooled samples	16	2011	wasterwater effluent	
PFBS	375-73-5	ng/l		2760	35796	France	individual samples	7	2015/2016	wasterwater effluent (point pollution FFF)	
PFHxS	355-46-4	ng/l		13509	62448	France	individual samples	7	2015/2016	wasterwater effluent (point pollution FFF)	
PFHpS	375-92-8	ng/l		1008	11780	France	individual samples	7	2015/2016	wasterwater effluent (point pollution FFF)	
PFOS	1763-23-1	ng/l		13271	50237	France	individual samples	7	2015/2016	wasterwater effluent (point pollution FFF)	
PFDS	39108-34-4	ng/l		n.d.	n.d.	France	individual samples	7	2015/2016	wasterwater effluent (point pollution FFF)	
PFBA	375-22-4	ng/l		3	11942	France	individual samples	7	2015/2016	wasterwater effluent (point pollution FFF)	
PFPeA	2706-90-3	ng/l		2804	33695	France	individual samples	7	2015/2016	wasterwater effluent (point pollution FFF)	
PFHxA	307-24-4	ng/l		9812	47689	France	individual samples	7	2015/2016	wasterwater effluent (point pollution FFF)	
PFHpA	375-85-9	ng/l		2092	45352	France	individual samples	7	2015/2016	wasterwater effluent (point pollution FFF)	
PFOA	335-67-1	ng/l		3035	16132	France	individual samples	7	2015/2016	wasterwater effluent (point pollution FFF)	
PFNA	375-95-1	ng/l		n.d.	n.d.	France	individual samples	7	2015/2016	wasterwater effluent (point pollution FFF)	
PFDA	335-76-2	ng/l		n.d.	n.d.	France	individual samples	7	2015/2016	wasterwater effluent (point pollution FFF)	
PFUnDA	2058-94-8	ng/l		n.d.	n.d.	France	individual samples	7	2015/2016	wasterwater effluent (point pollution FFF)	

ANNEX XV RESTRICTION REPORT – PFAS IN FIREFIGHTING FOAMS

PFDODA	307-55-1	ng/l		n.d.	n.d.	France	individual samples	7	2015/2016	wastewater effluent (point pollution FFF)	
PFTrDA	72629-94-8	ng/l		n.d.	n.d.	France	individual samples	7	2015/2016	wastewater effluent (point pollution FFF)	
PFTeDA	376-06-7	ng/l		n.d.	n.d.	France	individual samples	7	2015/2016	wastewater effluent (point pollution FFF)	
PFOSA	754-91-6	ng/l		n.d.	n.d.	France	individual samples	7	2015/2016	wastewater effluent (point pollution FFF)	
MeFOSA	31506-32-8	ng/l		n.d.	n.d.	France	individual samples	7	2015/2016	wastewater effluent (point pollution FFF)	
EtFOSA	4151-50-2	ng/l		n.d.	n.d.	France	individual samples	7	2015/2016	wastewater effluent (point pollution FFF)	
FOSAA	2806-24-8	ng/l		n.d.	n.d.	France	individual samples	7	2015/2016	wastewater effluent (point pollution FFF)	
MeFOSAA	2355-31-9	ng/l		n.d.	n.d.	France	individual samples	7	2015/2016	wastewater effluent (point pollution FFF)	
EtFOSAA	2991-50-6	ng/l		n.d.	n.d.	France	individual samples	7	2015/2016	wastewater effluent (point pollution FFF)	
PFBS	375-73-5	ng/l	6			Greece	pooled samples (triplicates)	3	2014	wastewater effluent	Gago-Ferrero et al. (2020)
PFDA	335-76-2	ng/l	50			Greece	pooled samples (triplicates)	3	2014	wastewater effluent	
PFHpA	375-85-9	ng/l	6			Greece	pooled samples (triplicates)	3	2014	wastewater effluent	
PFHps	335-77-3	ng/l	0.5			Greece	pooled samples (triplicates)	3	2014	wastewater effluent	
PFHxA	307-24-4	ng/l	4			Greece	pooled samples (triplicates)	3	2014	wastewater effluent	
PFHxS	355-46-4	ng/l	4			Greece	pooled samples (triplicates)	3	2014	wastewater effluent	
PFNA	375-95-1	ng/l	10			Greece	pooled samples (triplicates)	3	2014	wastewater effluent	

ANNEX XV RESTRICTION REPORT – PFAS IN FIREFIGHTING FOAMS

PFOA	2395-00-8	ng/l	6			Greece	pooled samples (triplicates)	3	2014	wastewater effluent	
PFOS	1763-23-1	ng/l	4			Greece	pooled samples (triplicates)	3	2014	wastewater effluent	
PFPeA	2706-90-3	ng/l	2			Greece	pooled samples (triplicates)	3	2014	wastewater effluent	
PFUnA	2058-94-8	ng/l	0.3			Greece	pooled samples (triplicates)	3	2014	wastewater effluent	
PFBA	375-22-4	ng/l	16			USA	individual samples	6	2014	wastewater effluent	Houtz et al. (2016)
PFPeA	2706-90-3	ng/l	12			USA	individual samples	6	2014	wastewater effluent	
PFHxA	307-24-4	ng/l	26			USA	individual samples	6	2014	wastewater effluent	
PFHpA	375-85-9	ng/l	4.4			USA	individual samples	6	2014	wastewater effluent	
PFOA	335-67-1	ng/l	21			USA	individual samples	6	2014	wastewater effluent	
PFNA	375-95-1	ng/l	8.4			USA	individual samples	6	2014	wastewater effluent	
PFDA	335-76-2	ng/l	3.5			USA	individual samples	6	2014	wastewater effluent	
PFBS	375-73-5	ng/l	2.7			USA	individual samples	6	2014	wastewater effluent	
PFHxS	355-46-4	ng/l	4.8			USA	individual samples	6	2014	wastewater effluent	
PFOS	1763-23-1	ng/l	13			USA	individual samples	6	2014	wastewater effluent	
PFBA	375-22-4	ng/l	7.4			USA	individual samples	6	2009	wastewater effluent	Klosterhaus et al. (2013)
PFPeA	2706-90-3	ng/l	6.7			USA	individual samples	6	2009	wastewater effluent	

ANNEX XV RESTRICTION REPORT – PFAS IN FIREFIGHTING FOAMS

PFHxA	307-24-4	ng /l	17			USA	individual samples	6	2009	wastewater effluent	
PFHpA	375-85-9	ng /l	5.3			USA	individual samples	6	2009	wastewater effluent	
PFOA	335-67-1	ng /l	32			USA	individual samples	6	2009	wastewater effluent	
PFNA	375-95-1	ng /l	12			USA	individual samples	6	2009	wastewater effluent	
PFDA	335-76-2	ng /l	3.8			USA	individual samples	6	2009	wastewater effluent	
PFBS	375-73-5	ng /l	6			USA	individual samples	6	2009	wastewater effluent	
PFHxS	355-46-4	ng /l	5.5			USA	individual samples	6	2009	wastewater effluent	
PFOS	1763-23-1	ng /l	24			USA	individual samples	6	2009	wastewater effluent	
PFBA	375-22-4	ng /l	7544			France	individual samples	1	2015	industrial wastewater effluent	Gomez-Ruiz et al. (2017)
PFPeA	2706-90-3	ng /l	52 500			France	individual samples	1	2015	industrial wastewater effluent	
PFHxA	307-24-4	ng /l	24 827			France	individual samples	1	2015	industrial wastewater effluent	
PFHpA	375-85-9	ng /l	37 847			France	individual samples	1	2015	industrial wastewater effluent	
PFOA	335-67-1	ng /l	2063			France	individual samples	1	2015	industrial wastewater effluent	
6:2 FTSA	27619-97-2	ng /l	382 200			France	individual samples	1	2015	industrial wastewater effluent	
8:2 FTSA	39108-34-4	ng /l	<LOQ			France	individual samples	1	2015	industrial wastewater effluent	
6:2 FTCA		ng /l	<LOQ			France	individual samples	1	2015	industrial wastewater effluent	

ANNEX XV RESTRICTION REPORT – PFAS IN FIREFIGHTING FOAMS

6:2 FTAB		ng /l	1 143 000			France	individual samples	1	2015	industrial wastewater effluent	Eriksson et al. (2017)
ΣPFCA		ng /l	22			Sweden	individual samples		2015	wastewater effluent	
ΣPFSA		ng /l	4.8			Sweden	individual samples		2015	wastewater effluent	
ΣFTSA		ng /l	2.5			Sweden	individual samples		2015	wastewater effluent	
ΣmonoPAP		ng /l	n.q.			Sweden	individual samples		2015	wastewater effluent	
ΣdiPAP		ng /l	n.q.			Sweden	individual samples		2015	wastewater effluent	
ΣPFPA		ng /l	1.3			Sweden	individual samples		2015	wastewater effluent	
ΣPFPIA		ng /l	0.1			Sweden	individual samples		2015	wastewater effluent	
ΣPFCA		ng /l	33			Sweden	individual samples		2015	wastewater effluent	
ΣPFSA		ng /l	7.7			Sweden	individual samples		2015	wastewater effluent	
ΣFTSA		ng /l	5.1			Sweden	individual samples		2015	wastewater effluent	
ΣmonoPAP		ng /l	<LOD			Sweden	individual samples		2015	wastewater effluent	
ΣdiPAP		ng /l	<LOD			Sweden	individual samples		2015	wastewater effluent	
ΣPFPA		ng /l	0.6			Sweden	individual samples		2015	wastewater effluent	
ΣPFPIA		ng /l	0.1			Sweden	individual samples		2015	wastewater effluent	
ΣPFCA		ng /l	66			Sweden	individual samples		2015	wastewater effluent	

ANNEX XV RESTRICTION REPORT – PFAS IN FIREFIGHTING FOAMS

ΣPFSA		ng/l	4.8			Sweden	individual samples		2015	wastewater effluent	
ΣFTSA		ng/l	2			Sweden	individual samples		2015	wastewater effluent	
ΣmonoPAP		ng/l	n.q.			Sweden	individual samples		2015	wastewater effluent	
ΣdiPAP		ng/l	<LOD			Sweden	individual samples		2015	wastewater effluent	
ΣPFPA		ng/l	3			Sweden	individual samples		2015	wastewater effluent	
ΣPFPIA		ng/l	2.1			Sweden	individual samples		2015	wastewater effluent	
PFHxA	307-24-4	ng/l	3.4	2.5	4.9	Finland	pooled samples	6	2009/2010	wastewater effluent	Perkola and Sainio (2013)
PFOA	335-67-1	ng/l	8	7	11	Finland	pooled samples	6	2009/2010	wastewater effluent	
PFOS	1763-23-1	ng/l	12	7.8	14	Finland	pooled samples	6	2009/2010	wastewater effluent	
PFDA	335-76-2	ng/l	0.5	<0.5	0.9	Finland	pooled samples	6	2009/2010	wastewater effluent	
PFHxA	307-24-4	ng/l	6.2	4.6	11	Finland	pooled samples	6	2009/2010	wastewater effluent	
PFOA	335-67-1	ng/l	12	9	15	Finland	pooled samples	6	2009/2010	wastewater effluent	
PFOS	1763-23-1	ng/l	10	3.8	20	Finland	pooled samples	6	2009/2010	wastewater effluent	
PFDA	335-76-2	ng/l	1	<0.5	1.3	Finland	pooled samples	6	2009/2010	wastewater effluent	
PFHxA	307-24-4	ng/l	4.7	2.8	9.5	Finland	pooled samples	6	2009/2010	wastewater effluent	
PFOA	335-67-1	ng/l	9.8	6.6	13	Finland	pooled samples	6	2009/2010	wastewater effluent	

ANNEX XV RESTRICTION REPORT – PFAS IN FIREFIGHTING FOAMS

PFOS	1763-23-1	ng/l	140	8	640	Finland	pooled samples	6	2009/2010	wastewater effluent	
PFDA	335-76-2	ng/l	0.88	<0.5	1.4	Finland	pooled samples	6	2009/2010	wastewater effluent	
PFHxA	307-24-4	ng/l	40	11	75	Finland	pooled samples	6	2009/2010	wastewater effluent	
PFOA	335-67-1	ng/l	49	8.7	100	Finland	pooled samples	6	2009/2010	wastewater effluent	
PFOS	1763-23-1	ng/l	880	320	1300	Finland	pooled samples	6	2009/2010	wastewater effluent	
PFDA	335-76-2	ng/l	1	<0.5	1.7	Finland	pooled samples	6	2009/2010	wastewater effluent	
PFBA	375-22-4	ng/l	4.4	<LOD	31.6	Spain	pooled sample	13	2016/2017	wastewater effluent	Lorenzo et al. (2019)
PFPeA	2706-90-3	ng/l	1.3	<LOD	16.6	Spain	pooled sample	13	2016/2017	wastewater effluent	
PFBS	375-73-5	ng/l	16.7	<LOD	101.3	Spain	pooled sample	13	2016/2017	wastewater effluent	
PFHxA	307-24-4	ng/l	3.2	<LOD	18.6	Spain	pooled sample	13	2016/2017	wastewater effluent	
PFHpA	375-85-9	ng/l	20.4	<LOD	60.9	Spain	pooled sample	13	2016/2017	wastewater effluent	
PFHxS	355-46-4	ng/l	17.6	<LOD	33.4	Spain	pooled sample	13	2016/2017	wastewater effluent	
PFHpS	375-92-8	ng/l	2.5	<LOD	11.1	Spain	pooled sample	13	2016/2017	wastewater effluent	
PFOA	335-67-1	ng/l	65.3	21.2	91.6	Spain	pooled sample	13	2016/2017	wastewater effluent	
PFOS	1763-23-1	ng/l	34.7	<LOD	58.3	Spain	pooled sample	13	2016/2017	wastewater effluent	
PFNA	375-95-1	ng/l	9.6	<LOD	27.8	Spain	pooled sample	13	2016/2017	wastewater effluent	

ANNEX XV RESTRICTION REPORT – PFAS IN FIREFIGHTING FOAMS

PFDA	335-76-2	ng/l	12.3	<LO D	12.3	Spain	pooled sample	13	2016/2017	wastewater effluent	
PFDS	39108-34-4	ng/l	n.d.	n.d.	n.d.	Spain	pooled sample	13	2016/2017	wastewater effluent	
PFUnDA	2058-94-8	ng/l	12.2	<LO D	12.2	Spain	pooled sample	13	2016/2017	wastewater effluent	
PFDoDA	307-55-1	ng/l	10.3	<LO D	10.3	Spain	pooled sample	13	2016/2017	wastewater effluent	
PFTrDA	72629-94-8	ng/l	25.3	<LO D	25.3	Spain	pooled sample	13	2016/2017	wastewater effluent	
PFTeDA	376-06-7	ng/l	14.7	<LO D	14.7	Spain	pooled sample	13	2016/2017	wastewater effluent	
PFHxDA	67905-19-5	ng/l	11.4	11.3	11.4	Spain	pooled sample	13	2016/2017	wastewater effluent	
PFODA	16517-11-6	ng/l	10	10	10	Spain	pooled sample	13	2016/2017	wastewater effluent	
PFHxA	307-24-4	ng/l	6.62			Sweden	24h composite samples		2013	wastewater effluent	Filipovic and Berger (2015)
PFHpA	375-85-9	ng/l	2.47			Sweden	24h composite samples		2013	wastewater effluent	
PFOA	335-67-1	ng/l	4.72			Sweden	24h composite samples		2013	wastewater effluent	
PFNA	375-95-1	ng/l	0.702			Sweden	24h composite samples		2013	wastewater effluent	
PFDA	335-76-2	ng/l	0.405			Sweden	24h composite samples		2013	wastewater effluent	
PFUnDA	2058-94-8	ng/l	0.046			Sweden	24h composite samples		2013	wastewater effluent	
PFDoDA	307-55-1	ng/l	<MDL			Sweden	24h composite samples		2013	wastewater effluent	
PFBS	375-73-5	ng/l	1.76			Sweden	24h composite samples		2013	wastewater effluent	

ANNEX XV RESTRICTION REPORT – PFAS IN FIREFIGHTING FOAMS

PFHxS	355-46-4	ng /l	4.07			Sweden	24h composite samples		2013	wastewater effluent
PFOS	1763-23-1	ng /l	5.03			Sweden	24h composite samples		2013	wastewater effluent
PFDS	39108-34-4	ng /l	<MDL			Sweden	24h composite samples		2013	wastewater effluent
FOSA	754-91-6	ng /l	0.096			Sweden	24h composite samples		2013	wastewater effluent
PFHxA	307-24-4	ng /l	13			Sweden	24h composite samples		2013	wastewater effluent
PFHpA	375-85-9	ng /l	1.05			Sweden	24h composite samples		2013	wastewater effluent
PFOA	335-67-1	ng /l	7.82			Sweden	24h composite samples		2013	wastewater effluent
PFNA	375-95-1	ng /l	0.517			Sweden	24h composite samples		2013	wastewater effluent
PFDA	335-76-2	ng /l	0.435			Sweden	24h composite samples		2013	wastewater effluent
PFUnDA	2058-94-8	ng /l	0.112			Sweden	24h composite samples		2013	wastewater effluent
PFDoDA	307-55-1	ng /l	<MDL			Sweden	24h composite samples		2013	wastewater effluent
PFBS	375-73-5	ng /l	0.116			Sweden	24h composite samples		2013	wastewater effluent
PFHxS	355-46-4	ng /l	0.285			Sweden	24h composite samples		2013	wastewater effluent
PFOS	1763-23-1	ng /l	0.822			Sweden	24h composite samples		2013	wastewater effluent
PFDS	39108-34-4	ng /l	<MDL			Sweden	24h composite samples		2013	wastewater effluent
FOSA	754-91-6	ng /l	0.056			Sweden	24h composite samples		2013	wastewater effluent

ANNEX XV RESTRICTION REPORT – PFAS IN FIREFIGHTING FOAMS

PFHxA	307-24-4	ng /l	7.89			Sweden	24h composite samples		2013	wastewater effluent	
PFHpA	375-85-9	ng /l	1.78			Sweden	24h composite samples		2013	wastewater effluent	
PFOA	335-67-1	ng /l	4.68			Sweden	24h composite samples		2013	wastewater effluent	
PFNA	375-95-1	ng /l	0.655			Sweden	24h composite samples		2013	wastewater effluent	
PFDA	335-76-2	ng /l	0.461			Sweden	24h composite samples		2013	wastewater effluent	
PFUnDA	2058-94-8	ng /l	0.133			Sweden	24h composite samples		2013	wastewater effluent	
PFDoDA	307-55-1	ng /l	0.052			Sweden	24h composite samples		2013	wastewater effluent	
PFBS	375-73-5	ng /l	0.552			Sweden	24h composite samples		2013	wastewater effluent	
PFHxS	355-46-4	ng /l	0.956			Sweden	24h composite samples		2013	wastewater effluent	
PFOS	1763-23-1	ng /l	2.1			Sweden	24h composite samples		2013	wastewater effluent	
PFDS	39108-34-4	ng /l	<MDL			Sweden	24h composite samples		2013	wastewater effluent	
FOSA	754-91-6	ng /l	0.064			Sweden	24h composite samples		2013	wastewater effluent	
PFPeA	2706-90-3	ng /l	76	3.1	209.4	Greece	24h composite samples		2009/2010	wastewater effluent	Arvaniti et al. (2012)
PFHxA	307-24-4	ng /l	1.2	<LOD	3.9	Greece	24h composite samples		2009/2010	wastewater effluent	
PFHpA	375-85-9	ng /l	5.3	1	11.5	Greece	24h composite samples		2009/2010	wastewater effluent	
PFOA	335-67-1	ng /l	21.1	12.7	34	Greece	24h composite samples		2009/2010	wastewater effluent	

ANNEX XV RESTRICTION REPORT – PFAS IN FIREFIGHTING FOAMS

PFNA	375-95-1	ng /l	2.3	<LO D	10.3	Greec e	24h composite samples		2009/2 010	wastewater effluent
PFDA	335-76-2	ng /l	3.1	<LO D	15.9	Greec e	24h composite samples		2009/2 010	wastewater effluent
PFUdA	2058-94-8	ng /l	5.9	<LO D	27.5	Greec e	24h composite samples		2009/2 010	wastewater effluent
PFDoA	307-55-1	ng /l	5.7	<LO D	33.9	Greec e	24h composite samples		2009/2 010	wastewater effluent
PFTTrDA	72629-94-8	ng /l	7.8	<LO D	46.6	Greec e	24h composite samples		2009/2 010	wastewater effluent
PFTeDA	376-06-7	ng /l	10.4	<LO D	62.4	Greec e	24h composite samples		2009/2 010	wastewater effluent
PFBS	375-73-5	ng /l	/	<LO D	/	Greec e	24h composite samples		2009/2 010	wastewater effluent
PFHxS	355-46-4	ng /l	2.9	<LO D	5.8	Greec e	24h composite samples		2009/2 010	wastewater effluent
PFHpS	375-92-8	ng /l	1.4	<LO D	8.6	Greec e	24h composite samples		2009/2 010	wastewater effluent
PFOS	1763-23-1	ng /l	12.5	5.2	21	Greec e	24h composite samples		2009/2 010	wastewater effluent
PFDS	39108-34-4	ng /l	5.9	<LO D	35.1	Greec e	24h composite samples		2009/2 010	wastewater effluent
PFOSA	754-91-6	ng /l	1.2	<LO D	7.1	Greec e	24h composite samples		2009/2 010	wastewater effluent
N-MeFOSA	31506-32-8	ng /l	/	<LO D	/	Greec e	24h composite samples		2009/2 010	wastewater effluent
N-EtFOSA	4151-50-2	ng /l	/	<LO D	/	Greec e	24h composite samples		2009/2 010	wastewater effluent
PFPeA	2706-90-3	ng /l	55.7	3.2	160. 3	Greec e	24h composite samples		2009/2 010	wastewater effluent
PFHxA	307-24-4	ng /l	0.5	<LO D	2.2	Greec e	24h composite samples		2009/2 010	wastewater effluent

ANNEX XV RESTRICTION REPORT – PFAS IN FIREFIGHTING FOAMS

PFHpA	375-85-9	ng /l	1.4	<LO D	4.4	Greece	24h composite samples		2009/2 010	wastewater effluent
PFOA	335-67-1	ng /l	7.2	<LO D	12.7	Greece	24h composite samples		2009/2 010	wastewater effluent
PFNA	375-95-1	ng /l	/	<LO D	/	Greece	24h composite samples		2009/2 010	wastewater effluent
PFDA	335-76-2	ng /l	/	<LO D	/	Greece	24h composite samples		2009/2 010	wastewater effluent
PFuDA	2058-94- 8	ng /l	2.1	<LO D	5.9	Greece	24h composite samples		2009/2 010	wastewater effluent
PFDoA	307-55-1	ng /l	/	<LO D	/	Greece	24h composite samples		2009/2 010	wastewater effluent
PFTTrDA	72629- 94-8	ng /l	/	<LO D	/	Greece	24h composite samples		2009/2 010	wastewater effluent
PFTeDA	376-06-7	ng /l	/	<LO D	/	Greece	24h composite samples		2009/2 010	wastewater effluent
PFBS	375-73-5	ng /l	/	<LO D	/	Greece	24h composite samples		2009/2 010	wastewater effluent
PFHxS	355-46-4	ng /l	0.39	<LO D	2.3	Greece	24h composite samples		2009/2 010	wastewater effluent
PFHpS	375-92-8	ng /l	0.08	<LO D	0.45	Greece	24h composite samples		2009/2 010	wastewater effluent
PFOS	1763-23- 1	ng /l	0.08	<LO D	0.45	Greece	24h composite samples		2009/2 010	wastewater effluent
PFDS	39108- 34-4	ng /l	2.6	1.1 D	4.6	Greece	24h composite samples		2009/2 010	wastewater effluent
PFOSA	754-91-6	ng /l	0.41	<LO D	2.5	Greece	24h composite samples		2009/2 010	wastewater effluent
N-MeFOSA	31506- 32-8	ng /l	/	<LO D	/	Greece	24h composite samples		2009/2 010	wastewater effluent
N-EtFOSA	4151-50- 2	ng /l	/	<LO D	/	Greece	24h composite samples		2009/2 010	wastewater effluent

10.3.2. Sewage sludge

Sewage sludge is a by product of waste water treatment in municipal and industrial sewage treatment plants and has been identified as relevant anthropogenic source for the release of PFASs into the environment (Kallenborn, 2004, Bossi et al., 2008). The recycling of sewage sludge as amendment for agricultural soils is a regular practice in the EU (Hudcová et al., 2019, Kacprzak et al., 2017) and is widely considered a potent release pathway of PFASs from sewage sludge (Schultz et al., 2006, Semerád et al., 2020, Bossi et al., 2008, Aro et al., 2021, Navarro et al., 2016). PFAS contamination of agricultural soil has been directly linked to sewage sludge amendments in the US (Washington et al., 2010) and China (Wen et al., 2014a). EU regulations do not require testing of sewage sludge for PFAS contamination before application (Hudcová et al., 2019). Therefore, data is limited.

Table 25 summarises data collected from 11 sources including published literature (Bossi et al., 2008, Campo et al., 2014, Navarro et al., 2016, Stasinakis et al., 2013, Ulrich et al., 2016, Aro et al., 2021, Semerád et al., 2020, Arvaniti et al., 2012) and government reports (Norwegian Institute for Water Research (NIVA), 2017, norman database, 2021). It represents samples from nine EU countries taken at different intervals between 2007 and 2019. 32 different PFASs were measured ranging from not detected to 7,6 mg/kg/dry weight (dw).

The data indicates that despite being listed under the Stockholm Convention, PFOS and PFOA still make up a large portion of PFASs in sewage sludge. Both substances show the highest concentrations in all countries except Greece, where PFOS concentrations were lower than those of PFOA, PFDA and PFNA. Additionally, measurements confirm that short-chain PFASs and substitutes such as HFPO-DA occur in European sewage sludge. There is a high variability of pollution levels between countries and between WWTPs of the same country.

Authors have hypothesized that soil amendments with PFAS contaminated sewage sludge can lead to leaching into ground water (Bossi et al., 2008, Semerád et al., 2020). The uptake of PFASs from sewage sludge contaminated soil into plants has already been demonstrated (Wen et al., 2014a, Lee et al., 2014), similarly to the uptake into soil organisms (Navarro et al., 2016). The migration of pollutants from soil to plants or soil organisms could facilitate a probable entry pathway into the food chain (Navarro et al., 2016).

Table 25. Collection of the levels detected in sewage sludge.

PFASs	CAS	Unit	Min	Max	Country	Matrix	Number of studies
L-PFBS		ng/g dw	0.41	175	Spain	sewage sludge	1
L-PFHpS		ng/g dw	0.13	9.37	Spain	sewage sludge	1
PFHpA		ng/g dw	0.33	55.1	Spain	sewage sludge	1
10:2 FTS		ng/g dw	0	3	Czech Republic	Sewage sludge - Municipal	1

ANNEX XV RESTRICTION REPORT – PFAS IN FIREFIGHTING FOAMS

4:2 FTS	757124-72-4	ng/g dw	0.15	0.34	Norway	seage sludge	1
5:3 FTA		ng/g dw	0	96.9	Czech Republic	Sewage sludge - Municipal	1
6:2 FTS	27619-97-2	ng/g dw	0.35	0.65	Norway	sludge	1
6:2 FTS	27619-97-2	ng/g dw	0	16.6	Czech Republic	Sewage sludge - Municipal	1
8:2 FTS	39108-34-4	ng/g dw	6.52	7.47	Norway	sludge	1
8:2 FTS	39108-34-4	ng/g dw	0	11.2	Czech Republic	Sewage sludge - Municipal	1
EtFOSA A		ng/g dw	0	7.1	Czech Republic	Sewage sludge - Municipal	1
FOSA		ng/g dw	0	32.4	Czech Republic	Sewage sludge - Municipal	1
HFPO-DA (Gen-X)		ng/g dw	0	2.5	Czech Republic	Sewage sludge - Municipal	1
i,p-PFNA		ng/g dw	1.33	75.6	Spain	sewage sludge	1
i,p-PFNS		ng/g dw	0.13	12.2	Spain	sewage sludge	1
L-PFDS		ng/g dw	0.01	0.01	Spain	sewage sludge	1
L-PFHxS		ng/g dw	0.01	0.01	Spain	sewage sludge	1
L-PFOA		ng/g dw		0.75	Denmark, Faroe Islands	Sewage sludge	1
L-PFOA		ng/g dw	0.79	0.87	Denmark	Sewage sludge	1
L-PFOA		ng/g dw	1.18	1.29	Norway	Sewage sludge	1
L-PFOS		ng/g dw	0.01	1790	Spain	sewage sludge	1
MeFOS AA		ng/g dw	0	3.4	Czech Republic	Sewage sludge - Municipal	1
PFBA	375-22-4	ng/g dw	0	27.8	Czech Republic	Sewage sludge - Municipal	1
PFBA	375-22-4	ng/g dw	0.13	1800	Spain	sewage sludge	1
PFBS	375-73-5	ng/g dw		12.7	Spain	biosolids	1
PFBS	375-73-5	ng/g dw	0	30.4	Czech Republic	Sewage sludge - Municipal	1
PFBS	375-73-5	µg/kg dw	13	49	Germany	sewage sludge	1
PFDA	335-76-2	ng/g dw	0.87	1.23	Finland	Sewage sludge	1

ANNEX XV RESTRICTION REPORT – PFAS IN FIREFIGHTING FOAMS

PFDA	335-76-2	ng/g dw	1.28	3.39	Norway	Sewage sludge	2
PFDA	335-76-2	µg/kg dw	1.9	3.4	Austria	sewage sludge compost	1
PFDA	335-76-2	ng/g dw		5.59	Denmark	Sewage sludge	1
PFDA	335-76-2	µg/kg dw	0	15.2	Greece	Sewage sludge	1
PFDA	335-76-2	µg/kg dw	1.1	7.7	Austria	sewage sludge	1
PFDA	335-76-2	ng/g dw		18.3	Spain	biosolids	1
PFDA	335-76-2	µg/kg dw	0	27.8	Sweden	Sewage sludge	2
PFDA	335-76-2	ng/g dw	0	44.9	Czech Republic	Sewage sludge - Municipal	1
PFDA	335-76-2	µg/kg/ dw	75	597	Germany	sewage sludge	1
PFDA	335-76-2	ng/g dw	0.09	666	Spain	sewage sludge	1
PFDoD A	307-55-1	ng/g dw		0.1	Spain	sewage sludge	1
PFDoD A	307-55-1	µg/kg dw	0.44	0.65	Austria	sewage sludge compost	1
PFDoD A	307-55-1	ng/g dw	1.1	1.24	Norway	Sewage sludge	2
PFDoD A	307-55-1	ng/g dw	0.73	1.79	Finland	Sewage sludge	1
PFDoD A	307-55-1	µg/kg dw	0.77	2.7	Austria	sewage sludge	1
PFDoD A	307-55-1	µg/kg dw	0	5.93	Sweden	Sewage sludge	1
PFDoD A	307-55-1	ng/g dw		9.1	Greece	sewage sludge	1
PFDoD A	307-55-1	ng/g dw	0	27	Czech Republic	Sewage sludge - Municipal	1
PFDoD A	307-55-1	µg/kg/ dw	28	325	Germany	sewage sludge	1
PFDS	335-77-3	ng/g dw	0.1	0.64	Norway	sludge	1
PFDS	335-77-3	ng/g dw	0	67	Germany	sewage sludge	1
PFDS	39108- 34-4	µg/kg dw		< LOQ	Austria	sewage sludge	1
PFHpA	375-85-9	µg/kg dw		0.52	Austria	sewage sludge	1
PFHpA	375-85-9	µg/kg dw	0.81	2.1	Austria	sewage sludge compost	1
PFHpA	375-85-9	µg/kg dw	0	3.43	Sweden	Sewage sludge	1

ANNEX XV RESTRICTION REPORT – PFAS IN FIREFIGHTING FOAMS

PFHpA	375-85-9	ng/g dw	0	7.4	Czech Republic	Sewage sludge - Municipal	1
PFHpA	375-85-9	µg/kg/ dw	0	123	German y	sewage sludge	1
PFHpS	375-92-8	µg/kg dw		0.53	Austria	sewage sludge	1
PFHpS	375-92-8	ng/g dw	0	5.4	Czech Republic	Sewage sludge - Municipal	1
PFHxA	307-24-4	ng/g dw		0.57	Denkma rk, Faroe Islands	Sewage sludge	1
PFHxA	307-24-4	ng/g dw		0.76	Norway	Sewage sludge	1
PFHxA	307-24-4	ng/g dw	0.92	1.53	Finland	Sewage sludge	1
PFHxA	307-24-4	ng/g dw	0.69	1.57	Denmar k	Sewage sludge	1
PFHxA	307-24-4	µg/kg dw	0	3.99	Sweden	Sewage sludge	2
PFHxA	307-24-4	µg/kg dw	0.35	9.8	Austria	sewage sludge	1
PFHxA	307-24-4	ng/g dw	1.33	11.1	Spain	sewage sludge	1
PFHxA	307-24-4	µg/kg dw	4.2	12	Austria	sewage sludge compost	1
PFHxA	307-24-4	ng/g dw	0	24.9	Czech Republic	Sewage sludge - Municipal	1
PFHxA	307-24-4	ng/g dw		32.2	Spain	biosolids	1
PFHxA	307-24-4	µg/kg/ dw	0	680	German y	sewage sludge	1
PFHxA	307-24-4	µg/kg dw	0	2.2	Greece	Sewage sludge	2
PFHxD A		ng/g dw	0.13	0.13	Spain	sewage sludge	1
PFHxS	355-46-4	µg/kg dw	< LOQ	1.4	Austria	sewage sludge compost	1
PFHxS	355-46-4	µg/kg dw		12	Denmar k	sewage sludge	1
PFHxS	355-46-4	ng/g dw		14.9	Spain	biosolids	1
PFHxS	355-46-4	ng/g dw	0	26.5	Czech Republic	Sewage sludge - Municipal	1
PFHxS	355-46-4	µg/kg/ dw	0	84	German y	sewage sludge	1
PFHxS	355-46-4	µg/kg dw		< LOQ	Austria	sewage sludge	1
PFNA	375-95-1	µg/kg dw		0.77	Austria	sewage sludge	1

ANNEX XV RESTRICTION REPORT – PFAS IN FIREFIGHTING FOAMS

PFNA	375-95-1	ng/g dw	0.56	0.85	Norway	Sewage sludge	2
PFNA	375-95-1	µg/kg dw	0.53	0.93	Austria	sewage sludge compost	1
PFNA	375-95-1	ng/g dw		5.19	Spain	biosolids	1
PFNA	375-95-1	ng/g dw	0.61	8	Denmark	Sewage sludge	2
PFNA	375-95-1	ng/g dw	0	8.2	Czech Republic	Sewage sludge - Municipal	1
PFNA	375-95-1	µg/kg dw	0	10.1	Greece	Sewage sludge	2
PFNA	375-95-1	µg/kg dw	0	10.4	Sweden	Sewage sludge	2
PFNA	375-95-1	µg/kg/ dw	22	171	Germany	sewage sludge	1
PFNA	375-95-1	ng/g dw	1.33	208	Spain	sewage sludge	1
PFOA	335-67-1	ng/g dw	0.72	1.37	Norway	sludge	1
PFOA	335-67-1	µg/kg dw	1.3	16.3	Greece	Sewage sludge	2
PFOA	335-67-1	µg/kg dw	0.68	6	Austria	sewage sludge	1
PFOA	335-67-1	µg/kg dw	4.4	6.4	Austria	sewage sludge compost	1
PFOA	335-67-1	ng/g dw		14	Spain	biosolids	1
PFOA	335-67-1	µg/kg dw	0	16.3	Sweden	Sewage sludge	1
PFOA	335-67-1	µg/kg dw		20	Denmark	sewage sludge	1
PFOA	335-67-1	ng/g dw	0	23.4	Czech Republic	Sewage sludge - Municipal	1
PFOA	335-67-1	ng/g dw	0.13	103	Spain	sewage sludge	1
PFOA	335-67-1	µg/kg/ dw	20	1043	Germany	sewage sludge	1
PFOdA		ng/g dw	2.67	59.9	Spain	sewage sludge	1
PFOS	1763-23-1	ng/g dw	4.86	5.65	Norway	sludge	1
PFOS	1763-23-1	ng/g dw	4.6	11.3	Greece	sewage sludge	1
PFOS	45298-90-6	µg/kg dw	6.3	8.2	Greece	Sewage sludge	1
PFOS	1763-23-1	µg/kg dw	4.7	18	Austria	sewage sludge compost	1
PFOS	1763-23-1	µg/kg dw	23	30	Austria	sewage sludge	1

ANNEX XV RESTRICTION REPORT – PFAS IN FIREFIGHTING FOAMS

PFOS	45298-90-6	µg/kg dw	0	54.8	Sweden	Sewage sludge	1
PFOS	1763-23-1	µg/kg dw		74	Denmark	sewage sludge	1
PFOS	1763-23-1	ng/g dw		83.5	Spain	biosolids	1
PFOS	1763-23-1	ng/g dw	0	998.4	Czech Republic	Sewage sludge - Municipal	1
PFOS	1763-23-1	µg/kg/dw	100	7600	Germany	sewage sludge	1
PFOSA	754-91-6	ng/g dw	0.43	0.46	Norway	sludge	1
PFOSA		ng/g dw	0.67	0.67	Spain	sewage sludge	1
PFOSA	754-91-6	µg/kg dw	0	2.51	Sweden	Sewage sludge	1
PFOSA		µg/kg dw		4	Denmark	sewage sludge	1
PFOSA		µg/kg/dw	23	99	Germany	sewage sludge	1
PFPeA		ng/g dw	0.66	0.84	Finland	Sewage sludge	1
PFPeA		ng/g dw		7.28	Spain	biosolids	1
PFPeA		ng/g dw	0	14	Czech Republic	Sewage sludge - Municipal	1
PFPeA		ng/g dw		5.6	Greece	sewage sludge	1
PFPeA		ng/g dw	0.13	1080	Spain	sewage sludge	1
PFPS	2706-91-4	ng/g dw	0.1	0.2	Norway	sludge	1
PFTeDA	376-06-7	ng/g dw	0	12.1	Czech Republic	Sewage sludge - Municipal	1
PFTeDA	376-06-7	ng/g dw		6.1	Greece	sewage sludge	1
PFTeDA	376-06-7	ng/g dw	0.07	93.7	Spain	sewage sludge	1
PFTTrDA	72629-94-8	ng/g dw	0.11	0.31	Finland	Sewage sludge	1
PFTTrDA	72629-94-8	ng/g dw		0.35	Norway	Sewage sludge	1
PFTTrDA	72629-94-8	ng/g dw	0	7.2	Czech Republic	Sewage sludge - Municipal	1
PFTTrDA	72629-94-8	ng/g dw	0.07	20.6	Spain	sewage sludge	1
PFUnDA	2058-94-8	µg/kg dw		0.37	Austria	sewage sludge compost	1
PFUnDA	2058-94-8	ng/g dw	0.56	1.07	Finland	Sewage sludge	1

PFUnD A	2058-94-8	ng/g dw	0.66	1.1	Norway	Sewage sludge	2
PFUnD A	2058-94-8	µg/kg dw		2.1	Austria	sewage sludge	1
PFUnD A	2058-94-8	ng/g dw	2.15	2.18	Denmark	Sewage sludge	1
PFUnD A	2058-94-8	ng/g dw		3209	Greece	sewage sludge	1
PFUnD A	2058-94-8	ng/g dw	2.84	3.29	Sweden	Sewage sludge	1
PFUnD A	2058-94-8	ng/g dw	0	5.7	Czech Republic	Sewage sludge - Municipal	1
PFUnD A	2058-94-8	ng/g dw	0.1	68.8	Spain	sewage sludge	1

10.4. Concentrations in biota

The detection of PFASs in wildlife, especially predators represents a direct concern for human health as many exposure pathways are similar due to the ubiquitous distribution of PFASs in food webs (Land et al., 2018). PFASs are detected in almost all individuals around the world. The analysis of PFASs in wildlife started with the detection of PFOS and PFOA and expanded to approximately 30 target PFASs, which are typically non-volatile perfluoroalkyl acids (PFAAs) that are analysed by LC-MS/MS. In biota, PFAAs are associated with protein-rich tissues such as liver, blood or kidney rather than lipophilic tissues due to their acidic nature and low pKa (De Silva et al., 2021, Armitage et al., 2012). For example, PFAAs have shown to be frequently associated with serum albumin or fatty acid binding proteins but also phospholipids were suggested to play an important role for accumulating and distributing PFAAs in internal tissues (Bischel et al., 2011, Armitage et al., 2012). Frequently targeted PFAAs comprise C₄-C₁₀ perfluorosulfonic acids (PFSAs) as well as C₆-C₁₄ perfluorinated carboxylic acids (PFCAs) (e.g. Figure 44). Among approximately 30 target PFAAs, PFOS typically reaches highest concentrations and detection rates in biota, irrespective of the investigated food web (Figure 44/Figure 45). PFOS/PFOSA as well as PFCAs of C_{8/9}-C_{11/12} chain length have shown to biomagnify in terrestrial (e.g. Müller et al., 2011b, Zhao et al., 2013) and aquatic food webs (e.g. Kelly et al., 2009, Xu et al., 2014). As a consequence, species of high trophic position (e.g. apex predators) accumulate high concentrations of certain PFASs in their tissues (Chen et al., 2021). Among European predators, especially Eurasian otters (*Lutra lutra*) have shown to have comparably high PFOS levels compared to other predators (Androulakis et al., 2022, Badry et al., 2022) (Figure 45). The fact that PFOS is still the most dominant PFASs in biota was suggested to be related to its persistence and the continued use of PFOS precursors like fluorotelomer alcohols and polyfluoroalkyl phosphate (Houde et al., 2011). However, not only adult animals are exposed to PFASs during their life span, many PFASs have shown to be already transferred via placenta or breast-feeding (maternal transfer), which can lead to high exposures of young individuals during a particular sensitive developmental stage (Chen et al., 2021).

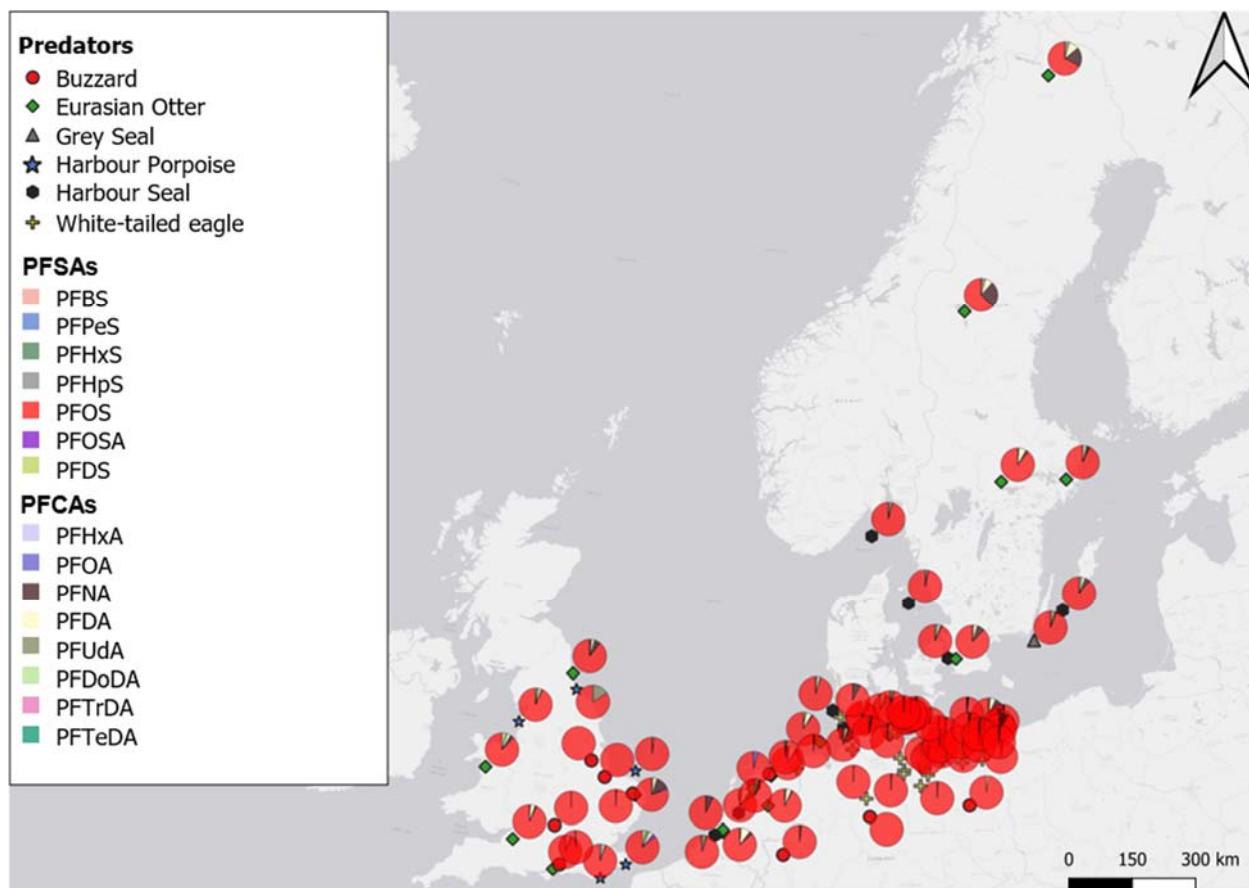

Figure 44. Composition of PFAAs in livers of apex predators from Europe (2015-2018) taken from Androulakakis et al. (2022) and Badry et al. (2022). Terrestrial species: Common buzzard (*Buteo buteo*). Freshwater species: Eurasian Otter (*Lutra lutra*). Marine species: Grey seal (*Halichoerus grypus*), Harbour seal (*Phoca vitulina*), harbour porpoise (*Phocoena phocoena*). Mixed food web feeder: White-tailed eagle (*Haliaeetus albicilla*). All samples have been analysed by the same laboratory (University of Athens).

Even though many target PFASs have shown to be widely distributed among food webs, certain risk factors such as proximity to industrial sites or local airports can considerably increase concentrations in European wildlife (e.g. Langberg et al., 2021, Ahrens et al., 2015). For example, PFOS concentrations in songbirds from Antwerp, Belgium showed particular high concentrations in the vicinity of a fluorochemical facility (Dauwe et al., 2007). These results demonstrate that even lower trophic level species can be heavily exposed. In the same region (Flanders, Belgium), raptors have shown elevated concentrations as well, which might be attributed to biomagnification of PFOS in local food webs (Meyer et al., 2009, Jaspers et al., 2013). In aquatic food webs, freshwater exposures of fish have been linked to the proximity to airports where PFASs are emitted via firefighting foams (Ahrens et al., 2015). Other important PFAS sources to freshwater fish were suggested to be related to wastewater effluents and industrial activities (Göckener et al., 2021, Langberg et al., 2021). As a consequence, apex predators of aquatic food webs have shown to accumulate high PFOS levels in proximity of potential point pollution sources (e.g. Badry et al., 2022). Besides freshwater species, European marine wildlife showed considerable exposure to PFASs as well (e.g. Figure 44/Figure 45, Trimmel et al. (2021)),

Pereira et al. (2021))). However, exposures are more difficult to link to specific sources due to diffuse entries and higher admixture compared to freshwater compartments.

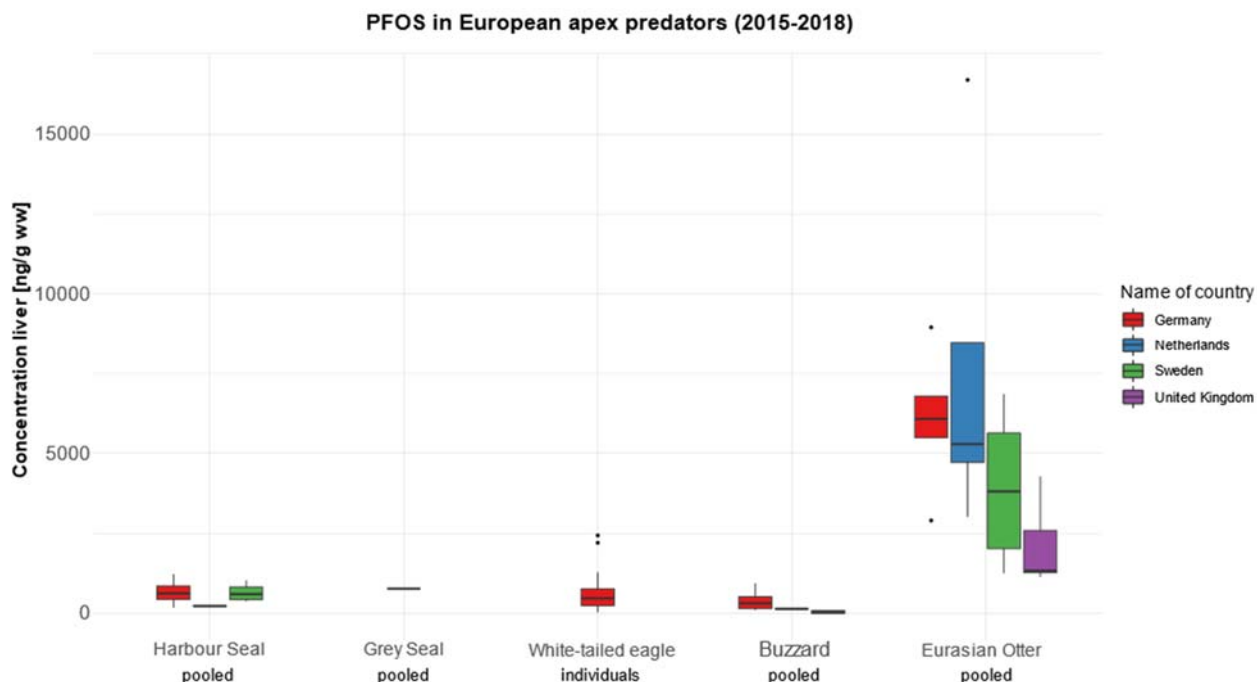

Figure 45. Boxplot of PFOS concentrations in livers of apex predators from central Europe presented in Figure 44. Freshwater species: Eurasian otter (*Lutra lutra*). Marine species: Grey seal (*Halichoerus grypus*) from SE, Harbour seal (*Phoca vitulina*) from DE, NL, SE. Terrestrial species: Common buzzard (*Buteo buteo*) from DE, NL, UK. Mixed food web feeder: White-tailed eagle (*Haliaeetus albicilla*) from DE. All samples have been analysed by the same laboratory (University of Athens). The lower and upper hinges of the box correspond to the 25th and 75th percentile. The upper/lower whisker extends from the hinge to the largest/smallest value no further than 1.5* interquartile range from the hinge. Data points beyond are plotted individually by black dots.

In Androulakakis et al. (2022)), Σ PFAS were one to four orders of magnitude higher in predatory species compared to lower trophic level species (non-predatory fish). However, those differences are probably also influenced by the sampling matrix as Androulakakis et al. (2022)) investigated muscles of fish species and livers of predators. Similar to the results of the apex predators, fish from freshwater compartments showed highest PFOS contamination (Figure 46). Not only wildlife species have shown to be widely exposed, also livestock (as well as game species) are frequently exposed but links to adverse effects (including human consumption of livestock) require further investigation (Death et al., 2021).

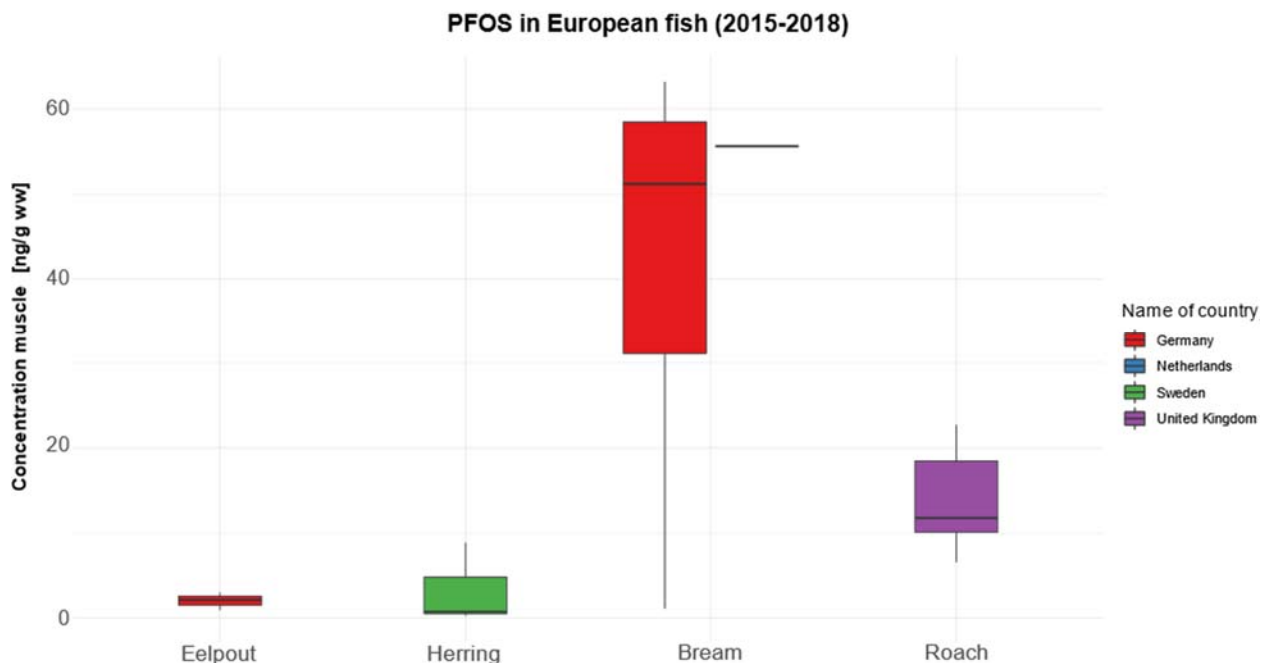

Figure 46. Boxplot of PFOS concentrations in pooled muscle samples of non-predatory fish species from Europe (Androulakis et al., 2022). Freshwater species: Bream (*Abrahmis brama*) from DE NL, Roach (*Rutilus rutilus*). Marine species: Eelpout (*Zoarces viviparus*), Herring (*Clupea harengus*). All samples have been analysed in the same laboratory (University of Athens). The lower and upper hinges of the box correspond to the 25th and 75th percentile. The upper/lower whisker extends from the hinge to the largest/smallest value no further than 1.5*interquartile range from the hinge. Data points beyond are plotted individually by black dots.

It is important to mention that the usually targeted PFAAs in biota represent only a small fraction of all currently used PFASs, which is mainly attributed to the lack of chemical standards and reference materials (Xiao, 2017, De Silva et al., 2021). Recent advances in analytical techniques led to the development of suspect and non-target screening methods for detecting a broader range of PFASs in biota samples (Barrett et al., 2021, Liu et al., 2018b). However, a disadvantage of suspect and non-target screening methods is that they are currently limited to qualitative (presence/absence) or semi-quantitative (relative concentrations) interpretation. The non-target screening method of Liu et al. (2018b)) detected 330 PFASs (C₄-C₁₈) in pooled fish samples (liver) from which the majority had at least 8 carbons in their chain. These results indicate that biota tend to accumulate rather long-chain PFASs, which is in agreement with previous studies targeting the conventional PFASs mentioned above. Interestingly, the suspect and non-target screening by Barrett et al. (2021)) in an endangered apex predator, the beluga whale (*Delphinapterus leucas*), determined 54 PFASs belonging to nine distinct groups, where unregulated short-chain PFASs increased over time. Suspect screening in 11 marine mammal species from the northern Hemisphere revealed the presence of 63 PFASs from 12 different classes (Spaan et al., 2020). Apart from PFOS in the majority of samples, 7:3 fluorotelomer carboxylic acid (7:3 FTCA) was most prevalent in a few samples. Other prevalent PFASs comprised PFNA (C₉) in polar bears from Greenland or PFUnDA (C₁₁) in cetaceans (Spaan et al., 2020). A recent review on PFASs in apex predators reported that 6:2 Cl-PFESA was the most frequently detected novel PFASs, which was suggested to be related to its similar trophic

magnification factor (3.37) to PFOS (3.92) (Chen et al., 2021). Other analytical advances besides suspect and non-target screening comprise e.g. the development of total fluorine (TOF) or extractable organic fluorine (EOF) measurements, which rely on the determination of atomic fluorine in a sample irrespective of the originating compound class (e.g. PFASs, pharmaceuticals, pesticides etc.) (De Silva et al., 2021). In livers of Baltic cod (*Gadus morhua*) from Sweden, time trends of TOF contrasted those of legacy PFASs and demonstrated large amounts of unidentified inorganic and organic fluorine in the samples (Schultes et al., 2020a). When considering EOF, a study on marine mammals from the northern Hemisphere revealed that for the majority of samples, the EOF was not significantly different to sum target PFASs (Spaan et al., 2020). However, for species from the US east coast, 30-75% of the EOF remained unidentified, which may be attributed to proximity to unidentified organofluorine sources (Spaan et al., 2020). Furthermore, killer whales (*Orcinus orca*) showed high amounts of unidentified fluorine (indicated by EOF) in their blubber, a matrix that generally showed low concentrations of target PFASs compared to e.g. liver or blood (Schultes et al., 2020b). Taken together, especially PFOS and long-chain PFASs are frequently detected in protein-rich tissues of almost all wildlife species, whereas novel analytical techniques demonstrate the presence of emerging PFASs such as 7:3 FTCA or 6:2 Cl-PFESA.

Finally, at a Swedish dairy cattle farm, the daily intake of PFASs by cows from consumption of silage was estimated to be 0.027 µg/kg, and the concentration of PFASs in cow tissues and milk was measured up to 0.228 µg/kg and 0.018 µg/L, respectively (Vestergren et al., 2013). Consumption of PFASs-contaminated edible crops and transfer through food chains represent important exposure pathways for humans to these chemicals (Domingo and Nadal, 2017).

Further data in biota can be found in the subsection “Measured levels indicating potential for long-range transport”.

10.5. Concentrations in plants

Generally, little data are available on PFASs contamination in plants since plants are usually not included in routine environmental monitoring programs. Based on the chemical structure and physico-chemical properties of the different PFASs subgroups the uptake, distribution and accumulation patterns in plants varies widely. Reported and measured levels of PFASs from field or semi-field condition studies with different plant species (e.g., cereals, vegetables and fruits) at contaminated sites were summarised by (Li et al., 2022) (Table 26). In most areas, the detected ΣPFASs in plants ranged from ng/g to µg/g levels. In contrast, the detected ΣPFASs in plants from background soil was at pg/g levels (Domingo and Nadal, 2017, Jian et al., 2017). The maximum ΣPFASs was 8085.18 ng/g dw in soybean taken from 0.3 km away from a fluorochemical manufacturing park (Liu et al., 2019). PFBA, PFPeA, PFHxA, PFHpA, and PFOA were the dominant PFASs, with the concentrations of 2378.31, 992.62, 211.80, 530.36, and 3966.62 ng/g dw, respectively Liu et al. 2019. As shown in Table 26, the fluorochemical manufacturing park was the most seriously contaminated source followed by firefighter training sites, landfills and wastewater treatment plants.

Fluorochemical manufacturing facilities, wastewater treatment plants and landfills are regarded as the hot-spot sources of PFASs emissions into the atmosphere (Wang et al., 2021, Ahrens et al., 2011b) application of biosolids is a common practice to improve soil quality, and is another major pathway to introduce PFASs into agricultural fields (Wen et

al., 2014b, Blaine et al., 2014). In the wheat-grass cultivated in aqueous film-forming foam polluted soils, the Σ PFASs varied up to 6190 ng/g wet weight (Bräunig et al., 2019). Plants grown in or near contaminated areas are frequently detected with measurable concentration of PFASs, confirming the capability of plants to absorb these contaminants from soils (Blaine et al., 2014, Jin et al., 2018, Kim et al., 2019, Wen et al., 2014b). As discussed by Li et al., 2022, high concentrations of PFASs are reported in plants particularly near fluorochemical manufacturing parks, firefighter training sites, landfills and wastewater treatment plants. For example, 8085 ng/g dry weight (dw) total concentrations of PFASs (Σ PFASs) were found in edible parts of crops taken from field around a fluorochemical industrial park (Liu et al., 2019). PFASs levels in plants from contaminated sites varied between ng/g and μ g/g levels, which likely causes oxidative damages in plants and health risks in human (Li et al., 2021).

Agricultural crops grown around fluorochemical industrial parks were found to contain high levels of PFASs; the total concentration was up to 87 μ g/kg wet weight (ww) in vegetables, 480 μ g/kg dry weight (dw) in wheat grains, and 59 μ g/kg dw in maize grains, which were attributed primarily to the nearby industrial discharges (Bao et al., 2019, Liu et al., 2017a, Liu et al., 2016). In addition, tree bark and leaves collected near a fluorochemical manufacturing park were also found to be contaminated with PFASs, suggesting that the airborne PFASs released from industries could be sorbed by the aboveground portions of plants (Jin et al., 2018). Fruits and vegetables collected from local markets in several European countries were frequently found with PFASs contamination (Herzke et al., 2013, Sznajder et al., 2018). In perennial grasses grown near a fluoropolymer manufacturing facility, the total concentrations of six PFCAs in grass leaves were in the range of 9–540 μ g/kg dw (Zhu and Kannan, 2019). As grasses are primarily used as livestock forage, PFASs accumulated in grasses may migrate to animals and eventually to humans via trophic food chains (Wang et al., 2020).

For further information on plant uptake and accumulation, see section B.4.4.

ANNEX XV RESTRICTION REPORT – PFAS IN FIREFIGHTING FOAMS

Table 26. Concentrations of PFASs in different plants species taken from contaminated sites (reviewed by Li et al. 2022)

Plant	Contaminant source	Unit	PFBA	PFPeA	PFHxA	PFHpA	PFOA	PFNA	PFDA	PFUnDA	PFDODA	PFBS	PFHxS	PFOS	Reference
Cereals															
Corn	Fluorochemical manufacturing parks	ng/g dw	1448.5 ₉	387.68	116.06	248.78	2478.4 ₄	1.13	0.61	0.12	0.07	0.29	<0.02	1.07	(Liu et al., 2019)
Maize	Wastewater treatment plant	pg/g dw				65		62				100			(Dalahmeh et al., 2018)
Maize	Fluorochemical manufacturing parks	ng/g dw	37.37	7.65	13.04	<0.10	0.40	<0.05	<0.07	<0.10	<0.06	<0.05	<0.04	0.23	(Liu et al., 2017a)
Rice	Wastewater treatment plant	ng/g ww				0.12	1.73	0.21	0.13	0.09	0.05				(Kim et al., 2019)
Soybean	Fluorochemical manufacturing parks	ng/g dw	2378.3 ₁	992.62	211.80	530.36	3966.6 ₂	1.63	0.97	0.30	0.20	<0.02	<0.02	2.35	(Liu et al., 2019)
Wheat	Fluorochemical manufacturing parks	ng/g dw	339	83.20	49	2.06	6.79	<0.05	<0.07	<0.10	<0.06	<0.05	<0.04	0.09	(Liu et al., 2017a)
Wheat	Fluorochemical manufacturing parks	ng/g dw	1102.5 ₁	495.77	134.69	51.19	809.75	0.42	0.81	0.14	<0.06	0.51	0.37	0.93	(Liu et al., 2019)
Wheat-grass	Aqueous film-forming foams	ng/g ww	766	466	515	17	16	0.80	<0.25			550	2790	1070	(Bräunig et al., 2019)
Vegetables															
Amaranth	Fluorochemical manufacturing parks	ng/g ww					2.20						0.50		(Li et al., 2019)
Balsam pear	Fluorochemical manufacturing parks	ng/g dw	3.54	0.25			0.16				0.10				(Zhang et al., 2020)
Cabbage	Fluorochemical manufacturing parks	ng/g dw	17.85	1.79	0.56	0.76	1.94	0.06	0.03				0.06	0.43	(Zhang et al., 2020)
Carrot	Fluorochemical manufacturing parks	ng/g dw	1.25				0.22				0.09				(Zhang et al., 2020)
Carrot	Fluorochemical manufacturing parks	ng/g dw	2552.7 ₄	852.31	196.85	229.07	1468.0 ₈	0.64	0.57	<0.04	<0.02	1.10	<0.02	1.31	(Liu et al., 2019)
Cauliflower	Fluorochemical manufacturing parks	ng/g dw	194.10	78.32	32.79	18.54	86.08	<0.05	<0.07	<0.10	<0.06	<0.02	0.04	0.32	(Liu et al., 2019)

ANNEX XV RESTRICTION REPORT – PFAS IN FIREFIGHTING FOAMS

Plant	Contaminant source	Unit	PFBA	PFPeA	PFHxA	PFHpA	PFOA	PFNA	PFDA	PFUnDA	PFDoDA	PFBS	PFHxS	PFOS	Reference
Celery	Fluorochemical manufacturing parks	ng/g dw	1049.61	324.06	94.30	88.27	1119.41	0.49	0.15	<0.04	<0.06	<0.02	<0.02	1.62	(Liu et al., 2019)
Chinese cabbage	Fluorochemical manufacturing parks	ng/g dw	1158.27	290.79	62.69	62.37	678.68	0.15	0.24	0.14	<0.02	<0.02	<0.02	3.38	(Liu et al., 2019)
Chinese chives	Fluorochemical manufacturing parks	ng/g dw	665.05	278.47	100.87	131.81	885.94	0.55	0.47	<0.04	0.15	0.26	<0.02	2.18	(Liu et al., 2019)
Cucumber	Fluorochemical manufacturing parks	ng/g ww	2.40				1.70								(Li et al., 2019)
Cucumber	Fluorochemical manufacturing parks	ng/g dw	63	0.85	0.32	0.26	2.60					15	0.31	0.12	(Bao et al., 2020)
Cucumber	Fluorochemical manufacturing parks	ng/g dw	13.55	4.68	1.36	0.18	0.42	0.06				0.06			(Zhang et al., 2020)
Eggplant	Fluorochemical manufacturing parks	ng/g dw	4.54	0.61	0.22		0.82	0.34	0.28	0.12	0.26				(Zhang et al., 2020)
Lettuce	Fluorochemical manufacturing parks	ng/g dw	2365.18	281.17	72.19	72.95	1038.27	0.09	0.21	0.2	<0.02	<0.02	<0.02	3.46	(Liu et al., 2019)
Pepper	Fluorochemical manufacturing parks	ng/g dw	946.46	415.86	74.39	18.01	39.29	0.15	<0.02	0.11	<0.06	<0.02	<0.02	0.62	(Liu et al., 2019)
Pumpkin	Fluorochemical manufacturing parks	ng/g dw	638.13	64.10	11.65	5.25	15.09	0.08	<0.07	0.12	<0.06	<0.02	<0.02	0.09	(Liu et al., 2019)
Radish	Fluorochemical manufacturing parks	ng/g dw	3.66	6.05	4.59	0.21	0.30	0.03			0.09				(Zhang et al., 2020)
Radish	Fluorochemical manufacturing parks	ng/g dw	1167.52	426.45	103.31	251.88	1879.76	0.67	0.84	<0.04	<0.06	<0.02	<0.02	1.85	(Liu et al., 2019)
Rape	Fluorochemical manufacturing parks	ng/g dw	7.70	2.99	3.44	0.18	1.82	0.02				0.19	0.02		(Zhang et al., 2020)
Spinach	Fluorochemical manufacturing parks	ng/g dw	6.70	1.79	3.90	0.47	2.49	0.02	0.10	0.05	0.22	0.17			(Zhang et al., 2020)
Sponge gourd	Fluorochemical manufacturing parks	ng/g dw	16.66	10.33	5.37	0.26	0.60				0.11			0.08	(Zhang et al., 2020)
Sweet pepper	Fluorochemical manufacturing parks	ng/g dw	1.44	0.90	0.71		0.17	0.08			0.10				(Zhang et al., 2020)
Tomato	Fluorochemical manufacturing parks	ng/g ww	3.90				0.40								(Li et al., 2019)

ANNEX XV RESTRICTION REPORT – PFAS IN FIREFIGHTING FOAMS

Plant	Contaminant source	Unit	PFBA	PFPeA	PFHxA	PFHpA	PFOA	PFNA	PFDA	PFUnDA	PFDODA	PFBS	PFHxS	PFOS	Reference
Tomato	Fluorochemical manufacturing parks	ng/g dw	3.15	2.74	1.41		0.18	0.02			0.12	0.25		0.19	(Zhang et al., 2020)
Tomato	Fluorochemical manufacturing parks	ng/g dw	87	1.30	0.56	0.32	1.70					13	0.29	0.15	(Bao et al., 2020)
Welsh onion	Fluorochemical manufacturing parks	ng/g dw	270.39	77.79	30.73	84.59	360.58	0.16	0.12	<0.04	<0.06	0.07	<0.04	0.10	(Liu et al., 2019)
White gourd	Fluorochemical manufacturing parks	ng/g ww	11.50												(Li et al., 2019)
White melon	Fluorochemical manufacturing parks	ng/g ww	8.50				1.20								(Li et al., 2019)
Yam	Wastewater treatment plant	pg/g dw				97	110	73				40			(Dalahmeh et al., 2018)
Zucchini	Fluorochemical manufacturing parks	ng/g dw	1.54	0.21	0.11		0.64	0.04		0.04	0.12				(Zhang et al., 2020)
-	Fluorochemical manufacturing parks	ng/g ww	69	3.10	0.28	<0.20	3.20	<0.20	<0.20			11	<0.20	<0.20	(Bao et al., 2020)
Fruits															
Grape	Fluorochemical manufacturing parks	ng/g ww	9.80		1	0.30	1.60	0.50					0.10		(Li et al., 2019)
Muskmelon	Fluorochemical manufacturing parks	ng/g ww	2.90				1								(Li et al., 2019)
Peach	Fluorochemical manufacturing parks	ng/g ww				0.20	1.30								(Li et al., 2019)
Pear	Fluorochemical manufacturing parks	ng/g ww	3.70			0.30	1			0.20					(Li et al., 2019)
Sugarcane	Wastewater treatment plant	pg/g dw				140	110	65							(Dalahmeh et al., 2018)
Watermelon	Fluorochemical manufacturing parks	ng/g ww	3.60			0.30	7.90								(Li et al., 2019)
Others															

ANNEX XV RESTRICTION REPORT – PFAS IN FIREFIGHTING FOAMS

Plant	Contaminant source	Unit	PFBA	PFPeA	PFHxA	PFHpA	PFOA	PFNA	PFDA	PFUnDA	PFDODA	PFBS	PFHxS	PFOS	Reference
Grass	Fluorochemical manufacturing facility	ng/g dw					190	4.50	11	23	30				(Zhu and Kannan, 2019)
Grass	Fluorochemical manufacturing facility	ng/g dw				17	520	0.86	1.20	3.70					(Zhu and Kannan, 2019)
Tree	Fluorochemical manufacturing facility	ng/g dw				7.30	700	5.80	4.30	8.60	4.20				(Zhu and Kannan, 2019)
Willow, maize, and pyramidalis	Fluorochemical manufacturing parks	ng/g dw	140	240	970	550	110	220			56	100	100	24	(Chen et al., 2018)Chen et al. (2018)
-	Fluorochemical manufacturing parks	ng/g dw		40.90	59.80	11.50	194	7.78	12.30	8.61	12.80	2.43	1.65	1.12	(Shan et al., 2014)
-	Fluorochemical manufacturing parks	ng/g dw		23.60	28.60	6.66	61.30	14.10	3.51	9.12	5.04	0.86	0.81	0.41	(Shan et al., 2014)
-	landfill	ng/g	4.60	0.12	0.03		0.04							0.03	(Scher et al., 2018)Scher et. 2018

10.6. Measured levels indicating potential for long-range transport

The information below is provided to support the assessment of long-range transport potential in section B.4.2.5.

Generally, field data are accepted as evidence for the long-range transport of a chemical if (1) measured levels are available in locations distant from the sources of its release; (2) monitoring data show that long-range environmental transport of the chemical may have occurred via air, water, or migratory species. However, the mere detection of a chemical in a remote region cannot necessarily be understood as evidence of long-range transport, as the potential influence of local sources has to be considered as well Scheringer (2009), since both long-range transport as well as local pollution may contribute to the presence of PFASs.

For the majority of PFASs no data on the long-range transport potential, transport pathways or point sources are available. While the long-range transport potential of PFASs is outlined in Annex B.4.2.5, this section focuses on the key studies reporting occurrence and concentrations in different environmental compartments in the Arctic (mainly based on the review by (Muir et al., 2019)) and Antarctica (summarised in the Table 27) as indications of potential long-range transport. These findings were complemented by analysis results from databases from AMAP monitoring campaigns and from national monitoring programs. We focus particularly on the few key studies that demonstrate a long-range transport from release source to target matrix analysed.

The sections below describe the measured levels of PFASs in different environmental compartments (air, seawater, freshwater, snow and ice, biota) in the Arctic and Antarctica.

ANNEX XV RESTRICTION REPORT – PFAS IN FIREFIGHTING FOAMS

Table 27. Collection of the levels detected in different matrices and biota in remote areas.

PFASs	CAS	Country	Matrix	Unit	Arithmetic mean	Minimum	Maximum	Number of studies
HFPO-DA	13252-13-6	Antarctica	surface water - snow	pg/L	6,3			1
PFBA	375-22-4	Antarctica	surface water - snow	pg/L		13	530	1
PFBS	375-73-5	Antarctica	surface water - snow	pg/L	17			1
PFDA	206-400-3	Antarctica	surface water - snow	pg/L		3.1	600	2
PFDoA	307-55-1	Antarctica	surface water - snow	pg/L		0.51	180	1
PFDS		Antarctica	surface water - snow	pg/L		0.1	1.2	2
PFHpA	375-85-9	Antarctica	surface water - snow	pg/L		23	310	2
PFHpS	357-92-8	Antarctica	surface water - snow	pg/L	0,6			1
PFHxA	307-24-4	Antarctica	surface water - snow	pg/L		2.3	230	2
PFHxS	355-46-4	Antarctica	surface water - snow	pg/L		0.12	7.3	2
PFNA	375-95-1	Antarctica	surface water - snow	pg/L		14	330	2
PFOA	335-67-1	Antarctica	surface water - snow	pg/L		29	1300	2
PFOS	1763-23-1	Antarctica	surface water - snow	pg/L	36			1
PFPeA	2706-90-3	Antarctica	surface water - snow	pg/L		1.5	73	2
PFTeA		Antarctica	surface water - snow	pg/L		20	20	1
PFTeDA		Antarctica	surface water - snow	pg/L	0,9			1
PFTrA		Antarctica	surface water - snow	pg/L		0.74	32	1
PFTrDA		Antarctica	surface water - snow	pg/L	0.5			1
PFUnA		Antarctica	surface water - snow	pg/L		2	150	1
PFUnDA		Antarctica	surface water - snow	pg/L	5.6			1
PFBA	375-22-4	Antarctica	Sediment	ng/g d.w.	1.24			1
PFPeA	2706-90-3	Antarctica	Sediment	ng/g d.w.	0.44			1
PFHxA	307-24-4	Antarctica	Sediment	ng/g d.w.	0.55			1
PFOA	335-67-1	Antarctica	Sediment	ng/g d.w.	0.23			1
PFNA	375-95-1	Antarctica	Sediment	ng/g d.w.	0.31			1
PFDA	206-400-3	Antarctica	Sediment	ng/g d.w.	0.10			1
PFUdA		Antarctica	Sediment	ng/g d.w.	0.20			1
PFTrA		Antarctica	Sediment	ng/g d.w.	0.11			1

ANNEX XV RESTRICTION REPORT – PFAS IN FIREFIGHTING FOAMS

PFBS	375-73-5	Antarctica	Sediment	ng/g d.w.	0.40		1
PFHxS	355-46-4	Antarctica	Sediment	ng/g d.w.	0.56		1
PFOS	1763-23-1	Antarctica	Sediment	ng/g d.w.	0.20		1
PFDA	206-400-3	Antarctica	marine water	pg/L		5.4 68	1
PFDoA	307-55-1	Antarctica	marine water	pg/L		0.5 8.9	1
PFDS		Antarctica	marine water	pg/L		0.23 0.23	1
PFHpA	375-85-9	Antarctica	marine water	pg/L		19 87	1
PFHxA	307-24-4	Antarctica	marine water	pg/L		2.1 30	1
PFHxS	355-46-4	Antarctica	marine water	pg/L		0.6 5.3	1
PFNA	375-95-1	Antarctica	marine water	pg/L		15 110	1
PFOA	335-67-1	Antarctica	marine water	pg/L		24 180	1
PFTeA		Antarctica	marine water	pg/L		25 25	1
PFTrA		Antarctica	marine water	pg/L		0.67 2.4	1
PFUnA		Antarctica	marine water	pg/L		2 27	1
FOSA		Antarctica	blood plasma	ng/g ww	52		1
PFBA	375-22-4	Antarctica	whole body (plancton)	ng/g dw		0.38 2	2
PFBA	375-22-4	Antarctica	feathers	ng/g dw	0,07-2,32		1
PFBS	375-73-5	Antarctica	feathers	ng/g dw	0.28		1
PFDA	206-400-3	Antarctica	blood plasma	ng/g ww	0.16		1
PFDA	206-400-3	Antarctica	feathers	ng/g dw	0.11		1
PFDA	206-400-3	Antarctica	algae	ng/g d.w.	0.04		1
PFDoA	307-55-1	Antarctica	algae	ng/g d.w.	0,12-0,34		1
PFDoA	307-55-1	Antarctica	blood plasma	ng/g plasma ww		<LOQ 0.12*10 ⁻³	1
PFDoDS		Antarctica	blood plasma	ng/g plasma ww		<LOQ <LOQ	1
PFHpA	375-85-9	Antarctica	whole body (plancton)	ng/g dw		0.13 4.6	1
PFHxA	307-24-4	Antarctica	whole body (plancton)	ng/g dw		0.045 0.46	1
PFHxA	307-24-4	Antarctica	blood plasma	ng/g ww	0.43		1
PFHxS	355-46-4	Antarctica	feathers	ng/g d.w.	0,05-0,19		1
PFNA	375-95-1	Antarctica	blood plasma	ng/g plasma ww		<LOQ-0,14*10 ⁻³	1
PFNA	375-95-1	Antarctica	feathers	ng/g d.w.	0.06		1

ANNEX XV RESTRICTION REPORT – PFAS IN FIREFIGHTING FOAMS

PFOA	335-67-1	Antarctica	whole body (mussel)	ng/g d.w.	0.08			1
PFOS	1763-23-1	Antarctica	feathers	ng/g d.w.	0,77-0,9			1
PFOS	1763-23-1	Antarctica	blood plasma	ng/g plasma ww	$0,25 \cdot 10^{-3}$ - $2,310^{-3}$			1
PFOS	1763-23-1	Antarctica	whole body (mussel)	ng/g d.w.	0.47			1
PFPeA	2706-90-3	Antarctica	whole body (plancton)	ng/g dw		0.22	5.9	1
PFTrA		Antarctica	feathers	ng/g d.w.	0.06			1
PFTrA		Antarctica	whole body (mussel)	ng/g d.w.	0.14			1
PFtrDA		Antarctica	blood plasma	ng/g ww	0,17-0,63			1
PFtrDA		Antarctica	blood plasma	ng/g ww	0,18-0,66			1
PFtrDA		Antarctica	whole body (mussel)	ng/g d.w.	0.07			1
PFUnA		Antarctica	whole body (plancton)	ng/g d.w.		0.001	0.014	1

10.6.1. Air/atmosphere

Both precursor-PFASs with and without a functional (ionic) moiety have been measured in the atmosphere at Arctic sites and in the northern Atlantic Ocean indicating potential transport of PFASs to the Arctic via air. Ionic PFASs have usually been measured in the particulate phase, while the neutral precursors have been measured in both the gas- and particulate phase. Many of the known PFAS precursor compounds have been ubiquitously detected in the atmosphere around the world, such as FTOHs, FASAs and perfluoroalkane sulfon-amidoethanols (FASEs) as reviewed by Kärrman et al. (2019). However, compared to the PFAS precursors, limited information is available about the environmental occurrence, sources and levels of other volatile PFASs with different chemical structures and uses.

Generally, to date, there is a limited number of atmospheric deposition measurements of short-chain PFASs, with only a handful made in remote regions. Also, temporal trend data for short-chain PFASs in the environment are very limited. Directly emitted short-chain PFCAs are unlikely to act as a large source to remote regions since these compounds have short atmospheric lifetimes that are assumed to be on the order of a few days, dominated by wet and dry deposition, analogous to other strong acids, such as nitric acid (Wu et al., 2014, Kotamarthi et al., 1998).

A recent study (Rauert et al., 2018) monitored PFASs at 21 sites within the Global Atmospheric Passive Sampling. Atmospheric concentrations previously reported from 2009 were compared to concentrations measured at these sites in 2013 and 2015, to assess trends over 7 years of monitoring. Concentrations of the FTOHs and FOSAs and FOSEs were stable at these sites from 2009 to 2015 with no significant difference in concentrations. At every site, the FTOHs dominated the profiles with highest concentrations of the 6:2 FTOH and 8:2 FTOH. Among FOSA and FOSES, only EtFOSA had high detection frequencies of 63 and 47% in 2013 and 2015, respectively. The FTOHs generally had higher detection frequencies with >68% detection of 8:2 FTOH and 10:2 FTOH. Concentrations of the sum of the three FTOHs (Σ FTOHs) at the three **Arctic** sites in the study (<0.4–21 pg/m³) were in line with those previously reported from the **Canadian Arctic** in 2004 of <1.5–35 pg/m³ (Stock et al., 2007), in 2005 of 7.0–55 pg/m³ (Shoeib et al., 2006) and North Greenland during 2008–2013 of <0.2–48 pg/m³ (Bossi et al., 2016). Of the FOSA/FOSEs, only EtFOSA was detected in the polar GAPS locations and concentrations were an order of magnitude lower than previously reported in the Arctic (Bossi et al., 2016, Ahrens, 2011).

Previous studies have investigated the ratios of the individual FTOHs to provide information on sources to the air mass sampled. As the 8:2 FTOH has the longest atmospheric residence time of the FTOHs (Wang et al., 2014, Bossi et al., 2016). A lower 8:2 FTOH ratio indicates direct emissions from localised sources in the area are contributing (Wang et al., 2014). A higher ratio of the 8:2 FTOH to the other FTOHs indicates that long-range atmospheric transport is a primary source to the region as shown for FTOH in **Arctic** regions (e.g. Bossi et al., 2016). The study by Bossi et al. (2016) investigated neutral per- and polyfluoroalkyl substances (PFASs) in the **Arctic** (North Greenland) in a multiyear series from 2008–2013. The average sum of the seven measured neutral PFASs (Σ_7 PFAS) ranged from 1.82 to 32.1 pg m⁻³. The most abundant compound was 8:2 FTOH (44% of Σ_7 PFAS), followed by 6:2 FTOH and 10:2 FTOH. FOSA and FOSE were also detected but at much lower concentrations than FTOHs. No significant temporal trend in concentration was observed.

Wong et al. (2018) report for the first time temporal trends of neutral and ionic PFASs in air from three **Arctic** stations: Alert (Canada, 2006–2014); Zeppelin (Svalbard, Norway, 2006–2014) and Andøya (Norway, 2010–2014). The most abundant PFASs were the perfluorooctanoic acid (PFOA), perfluorooctane sulfonic acid (PFOS), perfluorobutanoic acid (PFBA), and fluorotelomer alcohols (FTOHs). All of these chemicals exhibited **increasing trends** at Alert with doubling times of 3.7 years (y) for PFOA, 2.9 y for PFOS, 2.5 y for PFBA, 5.0 y for 8:2 FTOH and 7.0 y for 10:2 FTOH. In contrast, **declining or non-changing trends**, were observed for PFOA and PFOS at Zeppelin and Andøya. PFCAs were 3 to 30-fold higher at Zeppelin and Andøya compared to Alert. Alert is located at the northeastern tip of the Ellesmere Island and approximately 4 km from water which is covered by sea ice for most of the year, while the Norwegian sites are closer to open ocean waters. Wong et al. 2018 attributed this to sea spray aerosol due to proximity to the ocean of the Norwegian sites. Air concentrations of PFBA in Alert ranged from <0.0063 to 29 pg/m³) and it was mainly detected in the gas phase. The concentrations were within the same range as the urban sites in Europe (0.93–7.0 pg/m³, (Ahrens et al., 2013, Dreyer and Ebinghaus, 2009, Müller et al., 2012) which suggests that PFBA may be uniformly distributed in the northern hemisphere. Results of long-term air monitoring for PFOS and PFOA in airborne particles have been reported for Svalbard (Zeppelin Station) for the period 2006–2012 (Nilu, 2015). PFOA continues to be the predominant compound among the C₆–C₁₁–PFCAs in air. PFASs are monitored in air at several locations in Norway, but not many samples have been analyzed and the concentrations of many compounds are below the detection limits.

A recent report on screening for new contaminants at the **Arctic** Zeppelin station revealed several poly/perfluoro-compounds (PFHP), tris(perfluorobutyl)-amine (PFTBA), and 1,2,3,4-tetrachlorohexafluorobutane (TCHFB) in arctic air for the first time (Schlabach et al., 2018). These compounds are volatile and the authors noted that concentrations reported may therefore be underestimated (due to breakthrough in PUF samplers) although still indicating that these PFASs may undergo long-range transport (Schlabach et al., 2018). Neutral PFASs (FTOH, perfluorosulfonamides and sulfonamido-ethanols) have been measured since 2007 in northern Greenland and the results covering the period 2007–2015 have been summarized in a recent report (Skov et al., 2017). The most abundant compound was 8:2 FTOH (44% of Σ 7PFAS), followed by 6:2 FTOH (25% of Σ 7PFAS) and 10:2 FTOH (14% of Σ 7PFAS). The concentrations of FTOH were comparable with those measured at other High Arctic sites (Ny Ålesund (Zeppelin) and Alert).

Air samples collected on the *Amundsen* icebreaker during annual cruises in the Canadian Arctic since 2007 have been analyzed for PFASs. These data (Figure 47) build on earlier studies of PFASs in the Canadian Arctic using oceanographic cruises (Ahrens et al., 2011a, Shoeib et al., 2006).

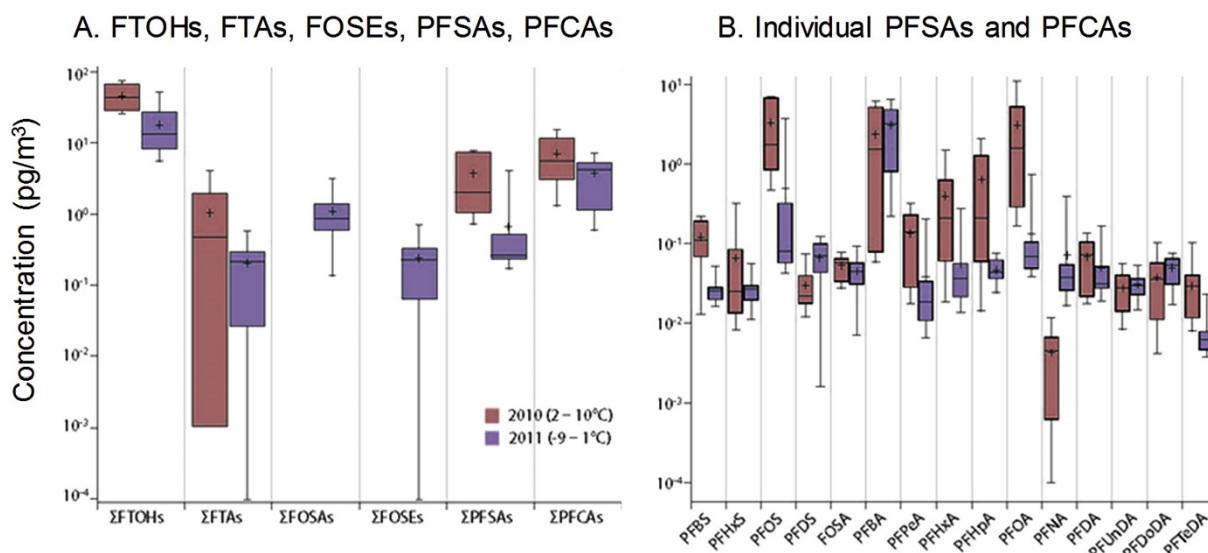

Figure 47. Box and whisker plots of PFAS concentrations for A) PFAS groups, Σ FTOHs, Σ FTAs, Σ FOSAs, Σ FOSEs, Σ PFCAs and Σ PFASs and B) individual PFASs and PFCAs in air (sum of particle and gas phases) measured in the Canadian Arctic from the Amundsen icebreaker (2010–11) reviewed by Muir et al. (2019). Boxes correspond to the interquartile range (25th and 75th percentiles), whiskers to the 5th and 95th percentiles. 2010 FOSAs and FOSEs are excluded owing to contamination in 2010 by MeFOSA and MeFOSEs.

Temporal trends of the n-PFAS in air from **Arctic** sampling sites have been investigated in previous studies e.g. by Wong et al. (2018). They reported slow **increasing trends** of the FTOHs at Alert from 2006 to 2014, and an expected doubling time of 5 and 10 years for 8:2 FTOH and 10:2 FTOH, respectively. Bossi et al. (2016), meanwhile, did not observe changes in concentrations of the FTOHs at North Greenland from 2008 to 2013. Global trends have also been investigated by Gawor et al. (2014) at up to 46 sites from 2006 to 2011. Higher levels of FTOHs compared to FOSAs, and FOSEs were observed at all sites.

Recently Yu et al. (2020) detected over one hundred individual PFASs in ambient air using innovative technologies consisting of cryogenic air sampler, a micro-to nano-sized particle fractionator (NPS) and non-target screening via ultra high resolution mass spectrometry. These results demonstrated the continued important role of volatile precursors for global distribution and transport of relatively stable PFASs, such as PFSA and PFCA.

10.6.2. Water

The global distribution and long-range transport of PFASs were investigated by Zhao et al 2012 using seawater samples collected from the Greenland Sea, East Atlantic Ocean and the Southern Ocean in 2009–2010. In the 76 marine surface water samples, 8 out of 15 PFASs were quantified in the Greenland Sea, AO and Southern Ocean. The Σ PFASs concentrations varied from non-detectable to 650 pg/L, and the average concentrations declined in three oceans in the following order: Atlantic (260 pg/L) > Greenland Sea (140 pg/L) > Southern Ocean (30 pg/L). Elevated levels of Σ PFASs were detected in the North Atlantic Ocean with the concentrations ranging from 130 to 650 pg/L. In the Greenland Sea, the Σ PFASs concentrations ranged from 45 to 280 pg/L, and five most frequently detected compounds were PFOA, PFHxS, PFHxA, PFOS and PFBS. PFOA (15 pg/L) and PFOS (25–45 pg/L) were

occasionally found in the Southern Ocean. In the Atlantic Ocean, the Σ PFASs concentration decreased from 2007 to 2010. The elevated PFOA level that resulted from melting snow and ice in Greenland Sea implies that the Arctic may have been driven by climate change and turned to be a source of PFASs for the marine ecosystem. The PFOA and PFOS distributions in the Southern Ocean were different from those in the Greenland Sea, but the marine current transport is still considered to be more important than atmospheric transport.

Joerss et al. (2020) investigated the spatial distribution of 29 PFASs in seawater was investigated along a sampling transect from Europe to the **Arctic** and two transects within Fram Strait, located between Greenland and Svalbard, in the summer of 2018. The replacement compound for PFOA, HFPO-DA, was detected in Arctic seawater for the first time. This provides evidence for its long-range transport to remote areas. The total PFAS concentration was significantly enriched in the cold, low-salinity surface water exiting the Arctic compared to warmer, higher-salinity water from the North Atlantic entering the Arctic (260 ± 20 pg/L versus 190 ± 10 pg/L). The higher ratio of PFHpA to PFNA in outflowing water from the Arctic suggests a higher contribution of atmospheric sources compared to ocean circulation. An east–west cross section of the Fram Strait, which included seven depth profiles, revealed higher PFAS concentrations in the surface water layer than in intermediate waters and a negligible intrusion into deep waters (>1000 m). Mass transport estimates indicated a net inflow of PFASs with ≥ 8 perfluorinated carbons via the boundary currents and a net outflow of shorter-chain homologues. The authors hypothesize that this reflects higher contributions from atmospheric sources to the Arctic outflow and a higher retention of the long-chain compounds in melting snow and ice representing potential local release sources of PFASs in remote areas such as the Arctic.

A recent study by Yamazaki et al. (2021) simultaneously measured atmospheric and seawater samples in the Taiwan Western Strait, western **Arctic Ocean**, and the **Antarctic Ocean**. Mean concentration of Σ_{12} PFAS in surface seawater and atmospheric samples were 1178 pg/L and 24 pg/m³ in the Taiwan Western Strait, 430 pg/L and 6 pg/m³ in the western Arctic Ocean, and 456 pg/L and 3 pg/m³ in the Antarctic Ocean. In oceanic air from the Taiwan Western Strait, FTOH and the ionic PFASs like PFSA and PFCA were found in 76% and 7% respectively. Regional comparison of air/water exchange (K_{AW}) and gas-particle (K_p) partition coefficients of PFASs in the oceanic environment indicated potential partitioning of ionic PFASs between surface seawater and oceanic air.

Ahrens et al. 2009 measured PFASs in surface water from the Atlantic Ocean along the longitudinal gradient from Las Palmas (Spain) to St. Johns (Canada) and along the latitudinal gradient from the Bay of Biscay to the South Atlantic Ocean (46° N to 26° S) in spring and fall 2007, respectively. No PFASs were detected in the particulate phase. Results indicate that **trans-Atlantic Ocean currents** caused decreasing concentration gradient from the Bay of Biscay to the South Atlantic Ocean and the concentration drop-off close to the **Labrador Sea in the Arctic**. Maximum concentrations were found for FOSA, PFOS, and PFOA at 302, 291, and 229 pg L⁻¹, respectively.

Several studies have investigated environmental processes that impact the distribution of PFASs although they have largely focused on highly contaminated zones with sampling areas that are in-land or coastal. The distribution of PFASs in the open ocean environment has not been well-characterized likely due to the challenge in quantitative analysis in a relatively clean ecosystem with low contamination level (Yamazaki et al., 2021). The first report of PFOS and PFOA in the **pristine environment** of 4400 m **deep open ocean water** collected from the

ANNEX XV RESTRICTION REPORT – PFAS IN FIREFIGHTING FOAMS

Central Pacific Ocean in 2003 (Yamashita et al., 2004) was presented in a twenty-year global monitoring survey of PFASs in open ocean. This study introduced new key concepts related to oceanic PFASs distribution: global circulation of PFASs via the open oceanwater current, accidental terrestrial discharge of PFASs to the ocean caused by the 2011 Tōhoku earthquake and tsunami (Yamazaki et al., 2015), and potential transportation of PFASs from the east China Sea to the Japan Sea (Yamazaki et al., 2019).

Yeung et al. (2017) determined C₆–C₁₂ PFCAs and C₄–C₁₀-PFASs, MeFOSAA, EtFOSAA, and FOSA in the **Arctic Ocean** including deep ocean and shelf waters. PFASs were generally only detectable above 150 m depth in the polar mixed layer (PML). Vertical profiles at 4 locations (Amundsen Basin and Nansen Basin) showed that PFOA and PFOS were the predominant PFASs, averaging 50 and 47 pg/L, respectively. PFBS (40 pg/L), PFNA (39 pg/L), PFHxA (37 pg/L) and PFHpA (35 pg/L) were widely detectable. Concentrations of PFASs in Alaskan continental shelf waters were similar to the ocean with PFOA predominating in almost all samples (detection frequency: 100%; mean 44 ng/L, median 42 ng/L); Figure 48.

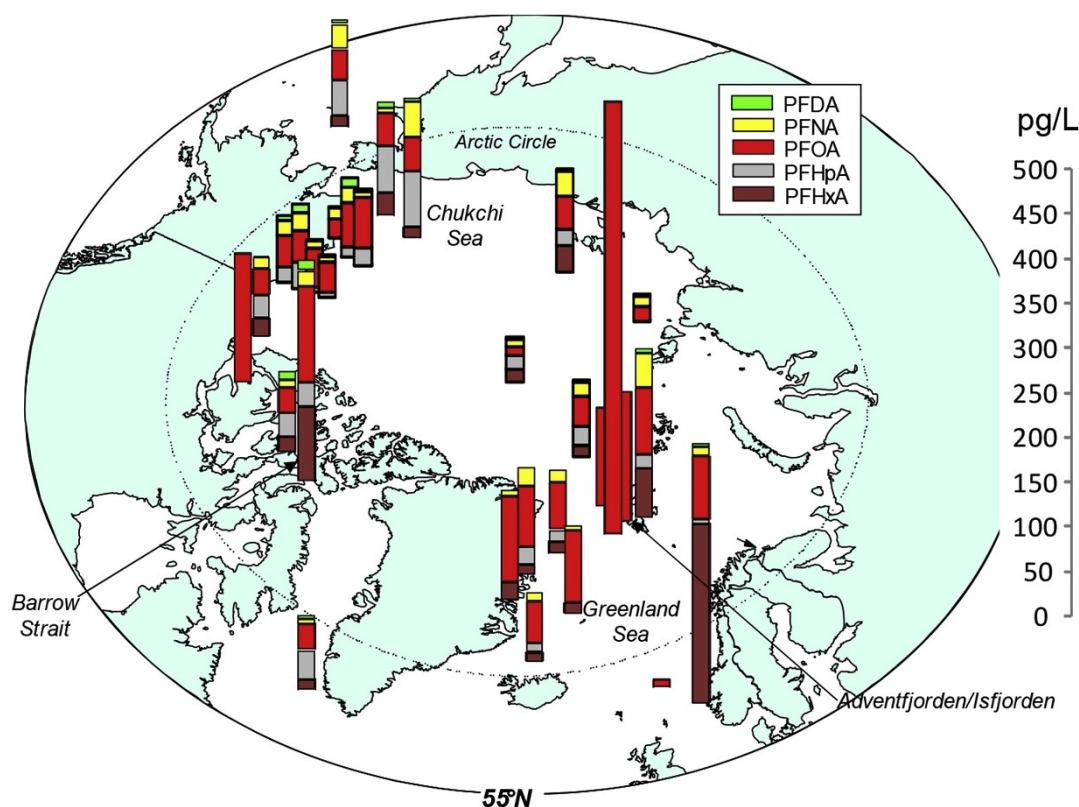

Figure 48. Average concentrations (pg/L) of C₆–C₁₀ PFCAs in Arctic seawater based on 9 in studies reviewed by Muir et al. 2019.

More recent measurements of PFCAs show that PFBA and PFPeA are the major PFASs in seawater at Barrow Strait in the central **Canadian Arctic Archipelago** (Muir, 2015a) and in **Chukchi Sea** waters (Cai et al., 2012) with concentrations 2- to 3-fold higher than PFOA. PFAS concentrations were generally higher in Greenland coastal waters than in open ocean measurements in the northern North Atlantic analyzed in the same studies (Muir, 2015a, Busch et al., 2010, Zhao et al., 2012). This may reflect the influence of freshwater inputs to these nearshore waters, as well as to sampling during the period of ice melt.

10.6.3. Freshwater

Studies on PFASs in water and sediments from Arctic freshwater environments are very limited. As of 2015, results for water and sediment samples were available for the Canadian Arctic, Faroe Islands, and Norway (Svalbard) and are summarized in the Supplement Table provided by Muir et al. 2019.

Lake PFAS concentrations measured by Stock et al. (2007) were generally consistent with ratios observed in Arctic glacial ice caps by Young et al. (2007) and in precipitation from rural and remote sites in North America (Scott et al., 2006), suggestive of a common atmospheric source. A publication (Lescord et al., 2015) compared PFAS concentrations in Resolute and Meretta Lakes, which had shown to be contaminated with high levels of PFOS, with other lakes near Resolute Bay (Stock et al. (2007)). Other PFASs were identified in Resolute and Meretta Lakes including PFECHS and fluorotelomer sulfonates (FTS) (4:2-, 6:2-, and 8:2 FTS).

10.6.4. Snow and ice

The geographical coverage for PFASs in snow or wet precipitation in the **Arctic** is very limited, with data available for northern Sweden, northern Norway, the Canadian Arctic islands, Svalbard and from ice/snow in the Beaufort Sea. Due to their physical-chemical properties, deposited PFASs and PFCAs accumulate during winter instead of volatilizing back to the atmosphere, and the accumulated PFASs are delivered to the receiving marine systems (from snow on top of sea ice and terrestrial catchment areas) and terrestrial systems (from the snow pack) when the snow/ice melts (Amap, 2014, Bertrand et al., 2014). Snowfall at mild temperatures can lead to a significant contribution of PFASs to the snowpack, where it accumulates through winter to be released to the surrounding environment at snow melt as discussed by (Muir et al., 2019).

Cai et al. (2012) determined PFASs in three sea ice core and snow samples (77–87°N) collected from North Pacific to the Arctic Ocean during 2010. Geographically, the average concentration of Σ PFC in surface water samples were $560 \pm 170 \text{ pg L}^{-1}$ for the Northwest Pacific Ocean, $500 \pm 170 \text{ pg L}^{-1}$ for the **Arctic Ocean**, and $340 \pm 130 \text{ pg L}^{-1}$ for the Bering Sea, respectively. The perfluoroalkyl carboxylates (PFCAs) were the dominant PFC class in the water samples, however, the spatial pattern of PFCs varied. The C₅, C₇ and C₈ PFCAs (i.e., PFPA, PFHpA, and PFOA) were the dominant PFCs in the Northwest Pacific Ocean while in the Bering Sea the PFPA dominated. The changing in the pattern and concentrations in Pacific Ocean indicate that the PFCs in surface water were influenced by sources from the East-Asian (such as Japan and China) and North American coast, and dilution effect during their transport to the Arctic. The presence of PFCs in the snow and ice core samples indicates an atmospheric deposition of PFCs in the Arctic. The elevated PFC concentration in the Arctic Ocean shows that the ice melting had an impact on the PFC levels and distribution. In addition, the C₄ and C₅ PFCAs (i.e., PFBA, PFPA) became the dominant PFCs in the Arctic Ocean indicating that PFBA is a marker for sea ice melting as the source of exposure.

Kwok et al. (2013) investigated PFAS concentrations in ice cores, surface snow and water samples collected from glaciers and downstream coastal areas of **Svalbard**. PFBA, PFOA, and PFNA were the predominant compounds found in ice-core samples. PFOA was the main PFASs detected in surface snow, while PFBA and perfluoropentanoate (PFPeA) were mainly found in surface water samples from glacial meltwater. MacInnis et al. (2019) determined

concentrations and loads (ng/m²) of PFASs in integrated snowpack samples from the catchment and ice surface of Lake Hazen by sampling in May/June 2013 and 2014. PFBA was the dominant PFASs, with concentrations averaging 2700 ± 3227 pg/L.

Concentrations of PFASs in Devon Ice cap snow were generally much lower than PFCAs, with PFBS predominating (54–226 pg/L). MacInnis et al. 2017 also reported perfluoro-4-ethylcyclohexane sulfonate (PFECHS) in Devon Ice cap snow (<0.3–20 pg/L). This was the first report confirming atmospheric deposition of this PFASs in the Arctic. It is reported to be used in aircraft hydraulic fluids.

Veillette et al. (2012) reported 6- to 15-fold lower concentrations of PFHpA, PFOA and PFNA in snow from the Lake A catchment (collected in 2008) near the north coast of Ellesmere Island than inland at Lake Hazen. Pickard et al. (2020) report multidecadal depositional fluxes for TFA, PFPrA, and PFBA from two Arctic ice cores. Fluxes of all three PFCAs increased starting around 1990, particularly of TFA.

Generally, little is known about how PFASs enter the **Arctic and Antarctic** marine system and cycle between seawater and sea ice compartments. Garnett et al. (2021b) investigated sea ice, snow, melt ponds, and near-surface seawater at two ice-covered **Arctic** stations located north of the Barents Sea (81 °N) with the aim of evaluate PFAA dynamics in the late-season ice pack. Sea ice showed high concentrations of PFAA particularly at the surface with snow-ice (the uppermost sea ice layer strongly influenced by snow) comprising 26–62% of the total PFAA burden. Low salinities (<2.5 ppt) and low δ¹⁸O_{H2O} values (<1‰ in snow and upper ice layers) in sea ice revealed the strong influence of meteoric water on sea ice, thus indicating a significant atmospheric source of PFAA with subsequent transfer down the sea ice column in meltwater. Importantly, the under-ice seawater (0.5 m depth) displayed some of the highest concentrations notably for the long-chain PFAA (e.g., PFOA 928 ± 617 pg L⁻¹), which were ≈3-fold higher than those of deeper water (5 m depth) and ≈2-fold higher than those recently measured in surface waters of the North Sea influenced by industrial inputs of PFAAs.

Similarly, Garnett et al. (2021a) recently showed that PFASs are incorporated into bulk sea ice during ice formation and individual PFASs (Garnett et al., 2021a) concentrations in bulk sea ice were linearly related to salinity. Long-chain PFASs (C8-C12), were enriched in bulk ice up to 3-fold more than short-chain PFASs (C4-C7) and NaCl. This suggests that chemical partitioning of PFASs between the different phases of sea ice also plays a role in their uptake during its formation. During sea ice melt, initial meltwater fractions were highly saline and predominantly contained short-chain PFASs, whereas the later, fresher meltwater fractions predominantly contained long-chain PFASs. This has direct implications for PFAS releases, distribution and long-range transport particularly facing global warming.

Xie et al. (2020) determined 16 PFASs in surface snow samples from **Antarctica** collected in summer 2016. PFOA (mean: 358 ± 71 pg/L) was the dominant compound of PFASs, and following by PFHxA (mean: 222 ± 97 pg/L), PFHpA (183 ± 60 pg/L) and PFPeA, (mean: 175 ± 105 pg/L). HFPO-DA (mean: 9.2 ± 2.6 pg/L) was determined in the Antarctic for the first time. Significantly positive correlations were observed between HFPO-DA and the short-chain PFASs, implying they have similar emission sources and long-range transport potential. Nevertheless, the exchange processes among different environmental matrices may drive the long-range transport and redistribution of the legacy and emerging Organic contaminants from coast to inland in the Antarctic.

10.6.5. Biota

PFASs are important environmental contaminants globally shown to be ubiquitous contaminants in Arctic and Antarctic wildlife since the early 2000s (Butt et al., 2010, Letcher et al., 2010, Llorca et al., 2012b, Muir et al., 2019). Previous reviews have covered studies on levels and trends of PFASs in the Arctic that were available till 2009 (Butt et al. 2010, Letcher et al. 2010). There are currently fewer data available for the terrestrial environment than for the freshwater and marine environments. The review by Muir et al. (2019) focussing on literature on PFASs in **the Arctic** including their precursors published between 2009 and 2018, revealed that an extensive dataset exists for long-term trends of long-chain PFCAs that have been reported in Arctic biota with some datasets including archived samples from the 1970s and 1980s.

PFAS concentrations in terrestrial animals are summarized in the [supplement table](#) provided by Muir et al. 2019. Müller et al. (2011a) measured PFASs in liver and muscle of caribou (*Rangifer tarandus*) from northern Yukon and NWT-western Nunavut as part of a terrestrial food web study. Highest PFAS liver concentrations were found for PFNA (2.2 ± 0.2 and 3.2 ± 0.4 ng/g ww, respectively) followed by PFDA (1.9 ± 0.1 and 2.2 ± 0.2 ng/g ww, respectively) and PFUnDA (1.7 ± 0.1 and 3.2 ± 0.2 ng/g ww, respectively). PFOS was the PFASs with the highest concentration (1.42 ng/g ww) in reindeer liver from southern Greenland followed by PFNA (0.84 ng/g ww) and PFUnDA (0.45 ng/g ww) (Bossi et al., 2015). Liver samples from Arctic fox (*Vulpes lagopus*) from Svalbard had the same PFAS distribution pattern as the Norwegian moose, except that PFTrDA was present at similar levels to PFUnDA (Aas et al., 2014). (Routti et al., 2017) determined PFASs in livers of arctic foxes from Svalbard collected over the period 1997–2014. PFAS patterns are in agreement with previous studies on arctic foxes showing that PFOS is the dominant PFASs followed by odd chain length PFCAs. Precursors to PFCAs such as 6:2 and 8:2 FTSA (33% and 13% detection frequency, respectively) were also detected in these foxes. Bossi et al. (2015) reported PFASs concentrations in liver samples from terrestrial biota (birds and mammals) from Greenland. Samples from ptarmigan (*Lagopus muta*; western Greenland), reindeer (southwestern Greenland) and muskox (*Ovibos moschatus*; eastern Greenland) were analyzed. PFAS concentrations in ptarmigan were mostly below detection limits but PFNA was detected in all samples analysed. PFNA, PFDA, PFUnDA and PFDoDA were detected in all samples.

A large number of measurements have been made on PFASs in freshwater fish, particularly in the Canadian Arctic and Norway, and recently in Greenland and the Faroe Islands (Bossi et al., 2015, Lescord et al., 2015). Detailed results for PFCAs are provided by Muir et al. (2019) in [Table S5](#). The long-chained (C₉–C₁₂) PFCAs predominate in freshwater fish, however the pattern differs in European Arctic compared with Greenland and Canada. This may be due in part to use of fish liver in Greenland, the Faroes and Svalbard versus fish muscle in Canada (Muir et al. 2019).

There are few recent studies on PFASs in **Arctic marine fish species**. Earlier work on marine fish was based mainly on food web studies and was reviewed by (Butt et al., 2010). PFAS concentrations were below detection limits in fish from West Greenland, Iceland and the Faroe Islands. (Braune et al., 2014a) determined C₆–C₁₅- PFCAs and PFBS, and PFHxS in forage fish from Coats Island (northern Hudson Bay, Nunavut). PFUnDA and PFTrDA were the most prominent PFCAs, with concentrations (whole fish) of <0.1–0.68 ng/g ww. Arctic

ANNEX XV RESTRICTION REPORT – PFAS IN FIREFIGHTING FOAMS

cod had the highest concentrations of ΣC_6-C_{15} -PFCAs (1.45, range 1.0–2.1 ng/g ww) followed by sculpins (1.40, range 1.0–1.7 ng/g ww).

Data on less reported and new emerging PFASs in ringed seals have been reported by Rotander et al. (2012), (Muir, 2015b) and (Gebbinck et al., 2016b) and are summarized in Figure 49 (published in Muir et al. 2019) and in [Table S7](#) of Muir et al. 2019.

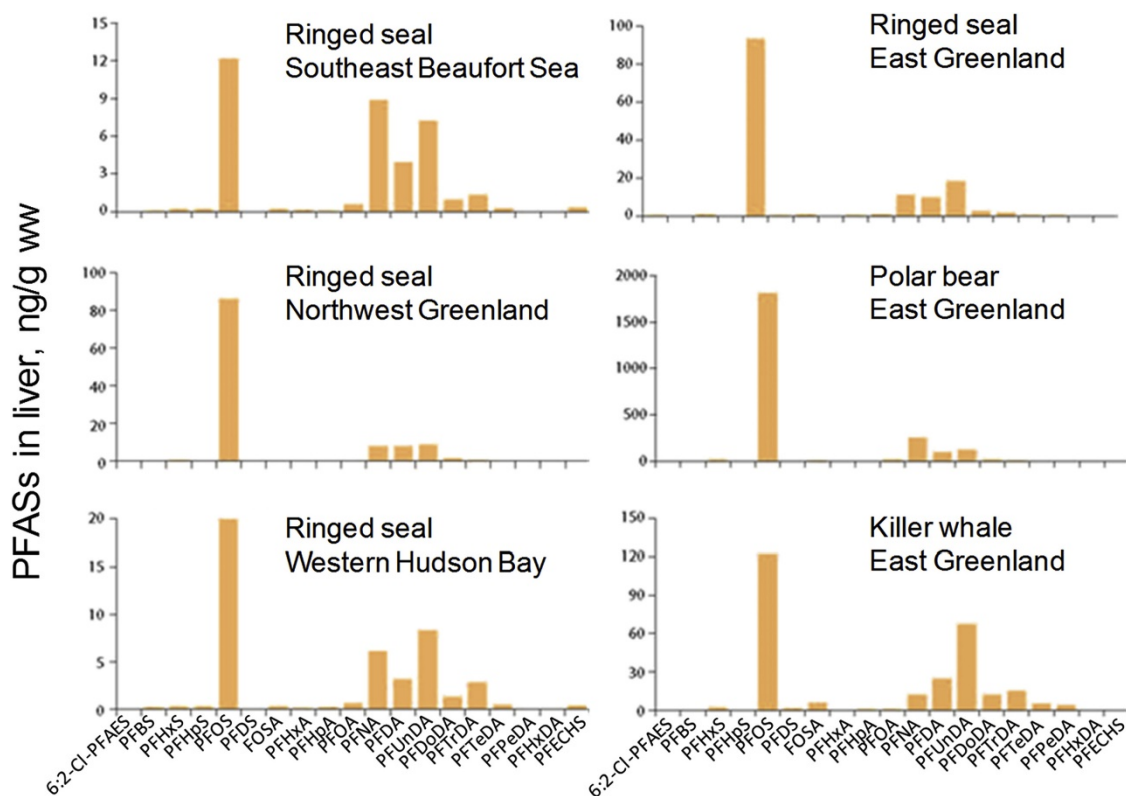

Figure 49. Concentrations and patterns of a large suite of PFASs in ringed seal liver from northern Canada and east and west Greenland (na = not analyzed). Based on data from Muir et al. (2019, 2015) and Gebbinck et al. (2012).

There is more information available about PFASs in **polar bears** from sub-populations in East Greenland and in southern and western Hudson Bay in Canada compared to the Norwegian Arctic (Svalbard) although a few studies have been published from Svalbard area during the last years. One recent study investigated levels of PFASs in plasma from Svalbard polar bears (Herzke, 2013). PFOS was the predominant PFASs (205 ng/mL plasma), followed by the longer odd-chained PFCAs; PFNA and PFUnDA at 37.6 and 25.5 ng/mL, respectively. Low ng/g concentrations of C₄ perfluorobutane sulfonamide (FBSA) were reported for the first time in polar bear liver FBSA was detectable at a frequency of 12% in livers of western Hudson Bay bears, but totally non-detectable in liver of southern Hudson Bay bears (Letcher et al., 2014). This was the first detection of FBSA, a precursor of PFBS, in an Arctic biota sample. PFBS was also detectable (frequency 53–54%) in the Hudson Bay polar bear liver samples.

Liu (2018) detected 3 new classes of PFASs in pooled **polar bear liver** plasma from Western Hudson Bay and the Southern Beaufort Sea populations using a nontarget high resolution mass spectrometry method. Class I were cyclic or unsaturated PFASs indicating a ring or double-bond in the core structures. Class 2 had unique $[C_2F_5O]^-$ ions and were

characterized by the simultaneous detection of PFSA-specific ions (e.g. $[\text{SO}_3]^-$ and $[\text{SO}_3\text{F}]^-$). Class 3 included unsaturated ether-, cyclic ether-, or carbonyl-PFSAs. Class 4 consisted of x:2 chlorine-substituted perfluoroalkyl ether sulfonates including F-53B previously reported by (Gebbink et al., 2016b) in polar bear liver, the C6 and C7-homologs were also detected.

Trends in PFCAs in biota over time vary among the same species across the North American **Arctic**, East and West Greenland, and Svalbard. Most long-term time series show a decline from higher concentrations in the early 2000s. However there have been recent (post 2010) increasing trends of PFCAs in ringed seals in the Canadian Arctic, East Greenland polar bears and in arctic foxes in Svalbard. Annual biological sampling is helping to determine these relatively short-term changes. Rising levels of some PFCAs have been explained by continued emissions (Letcher et al., 2018) of long-chain PFCAs and/or their precursors and inflows to the Arctic Ocean, especially from the North Atlantic. While the effectiveness of biological sampling for temporal trends in long-chain PFCAs and PFSAs has been demonstrated, this does not apply to the C₄–C₈-PFCAs, FBSA, or PFBS which are generally present at low concentrations in biota.

Sun et al. (2019a) reconstructed the first long-term (1968-2015) spatiotemporal trends of PFASs using archived body feathers of white-tailed eagles (*Haliaeetus albicilla*) from the **Arctic** (West Greenland, n = 31), Norwegian (n = 66), and Central Swedish Baltic coasts (n = 50). Concentrations of FOSA and PFOS had started decreasing significantly since the mid-1990s to 2000 in the Greenland and Norwegian subpopulations, consistent with the 3M phase-out, though in sharp contrast to overall increasing trends observed in the Swedish subpopulation. Σ PFCA concentrations significantly increased in all three subpopulations throughout the study periods. These temporal trends suggest on-going input of PFOS in the Baltic and of Σ PFCAs in all three regions. PFOS dominated the PFAS profiles in the Swedish and Norwegian subpopulations, in contrast to the domination of FOSA and Σ PFCAs in the Greenland one.

Although C₁₃–C₁₅-PFCAs had been reported previously in Arctic marine biota, particularly in seabirds additional measurements have shown that these compounds are present in most top predators. Early studies on spatial and **temporal trends of PFASs in Arctic marine mammals** were reviewed by Butt et al. (2010) and recently temporal trends of PFOS in marine biota have been included in the AMAP temporal trend assessments.

Butt et al. 2010 previously reviewed spatial and temporal trends of PFSAs in seabirds and therefore only reports published after 2009 are considered here. More recent work has involved analyses of seabird liver or eggs from Norway, the Faroe Islands, and Greenland, as well as Nunavut, and is summarized in [Table S7](#) of Muir et al. 2019 and plotted in Figure 50 for 6 bird species.

ANNEX XV RESTRICTION REPORT – PFAS IN FIREFIGHTING FOAMS

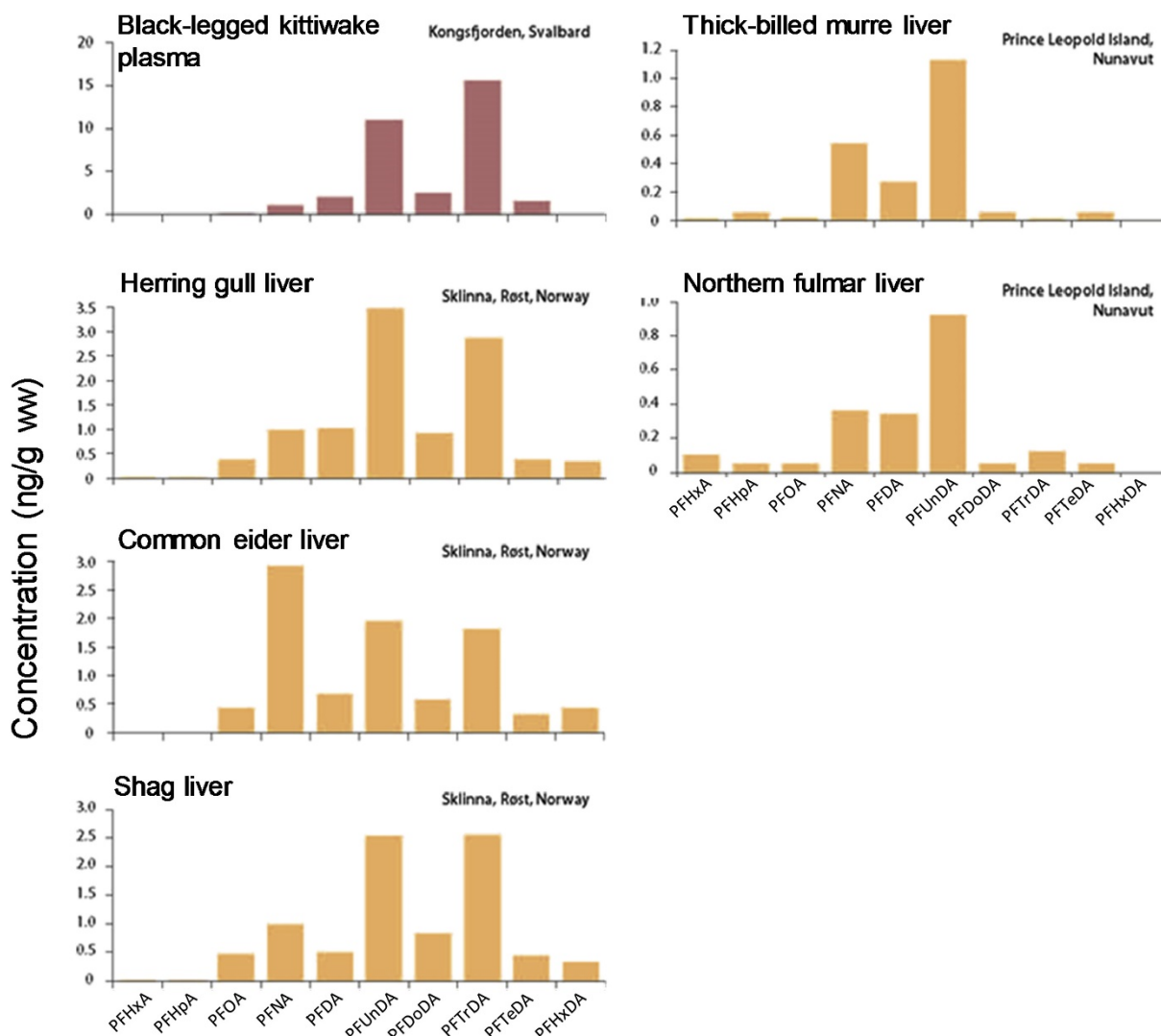

Figure 50. Concentrations and patterns of C₆–C₁₆–PFCAs in liver of common eider (Sklinna, Røst, Norway), herring gull and shag (Sklinna, Røst, Norway), thick-billed murre and northern fulmar (Prince Leopold Island, Lancaster Sound, Nunavut) and in plasma of black-legged kittiwakes (Kongsfjorden, Svalbard). Results from Norway are from (Huber et al., 2015, Tartu et al., 2014) and for Nunavut from Braune et al. (Braune et al., 2014b)

Although C₁₃–C₁₅–PFCAs had been reported previously in Arctic marine biota, particularly in seabirds additional measurements have shown that these compounds are present in most top predators. Early studies on spatial and **temporal trends of PFASs in Arctic marine mammals** were reviewed by Butt et al. (2010) and recently temporal trends of PFOS in marine biota have been included in the AMAP temporal trend assessments.

By now, PFASs are also found in several **biota species** living in **Antarctica**. For instance, Bengtson Nash et al. (2010) analysed a range of **Antarctic**, sub-Antarctic and Antarctic-migratory biota for key ionic PFASs in order to investigate the extent to which PFASs have permeated the Southern Ocean/Antarctic food web to date. Analytical findings, together with previous reports, revealed only the occasional occurrence of PFCs in migratory biota and vertebrate predators with foraging ranges extending into or north of the Antarctic Circumpolar Current. However, study period was more than 10 years. The authors found that geographical contamination patterns observed correspond most strongly with those expected from delivery

via hydrospheric transport as governed by the unique oceanographic features of the Southern Ocean. This suggest that hydrospheric transport will form a slow, but primary, input pathway of PFCs to the Antarctic region.

Routti et al. (2015) report for the first time detectible concentrations of PFASs in an endemic **Antarctic** marine mammal species. PFASs concentrations of 18 PFASs were determined in blood plasma of adult lactating Weddell seals (*Leptonychotes weddellii*, n = 10) from McMurdo Sound, Antarctica. PFUnDA was detected in all samples at concentrations ranging from 0.08 to 0.23 ng/ml. PFOS, PFHxA and PFTriDA were sporadically detected, while the remaining compounds were below the limit of detection. The authors suggest that PFASs have been subjected to long-range atmospheric transportation and/or derive from a local source. A review of these and published data indicate that PFCAs dominate in biotic PFAS patterns in species feeding south of the Antarctic Circumpolar. Current, whereas PFOS was the major PFASs detected in species feeding predominantly north of the current. The influence of long-range transport of PFASs to Antarctica has recently been debated, since PFASs have mostly been detected in sub-Antarctic or migratory Antarctic biota including white-chinned petrels (*Procellaria aequinoctialis*), South polar skua (*Stercorarius maccormicki*), Southern elephant seals (*Mirounga leonine*) and Antarctic fur seals (*Arctocephalus gazella*) but only in few resident Antarctic species such as Adelie and Gentoo penguins (*Pygoscelis adeliae* and *Pygoscelis papua*) (Tao et al., 2006, Schiavone et al., 2009, Bengtson Nash et al., 2010). Furthermore, few detections of PFASs were reported in eggs and muscle tissue of Gentoo and Adelie penguins (Schiavone et al. 2009). South of the Polar Front (49–65°S depending on longitude (Orsi et al., 1995) demarks the southern reach of subantarctic waters, and the northward and circumpolar movement of surface and subsurface waters further south in the Southern Ocean provides a barrier that protects organisms that feed further south, such as Weddell seals (Routti et al., 2015). Only trace levels of mainly PFOS (5–51 pg/L) and PFOA (13–15 pg/L) as well as lesser amounts of PFBS (2.9 pg/L) and PFDoDA (1.1 pg/L) have been detected in Antarctic offshore sea water samples (Zhao et al., 2012, Wei et al., 2007, Ahrens et al., 2010). However, in addition to direct exposure, PFUnDA in Antarctic and Arctic biota may originate from long-range atmospheric transport of fluorotelomer alcohols (FTOHs) and their subsequent degradation to PFCAs, i.e., indirect exposure (Routti et al., 2015). FTOHs are the dominant group of volatile fluorinated chemicals in the Antarctic atmosphere (Del Vento et al., 2012) and their atmospheric oxidation is likely an important source of PFCA pollution in polar regions (Ellis et al., 2004). PFUnDA, is one of the degradation products of 10:2 FTOH, which is the dominant FTOH, together with 8:2 FTOH, detectable in Antarctic air masses (Del Vento et al., 2012, Dreyer et al., 2009). Although atmospheric formation of PFCAs from FTOHs is relatively low under polar environmental conditions (Wania, 2007), post-depositional transformation of FTOHs into PFCAs may also occur on the snow surface (Taniyasu et al., 2013) as well as via metabolic degradation in organisms (Butt et al., 2014).

Gao et al. (2020) recently investigated the occurrence of PFASs in an **Antarctic** ecosystem (sediment, algae, and biota samples) in the Fildes Peninsula at King George and Ardley Island. The profiles, spatial distribution, and trophic transfer behavior of PFASs were studied. Σ PFASs ranged from 0.50 ± 38.0 ng/g dw (dry weight) in algae to 4.97 ± 1.17 ng/g dw in Neogastropoda (Ngas), which was lower than those in the low- and mid-latitude regions and even Arctic regions. PFBA was predominant with detection frequencies above 50% in all types of samples, and the relative contribution of PFBA ranged from 22% to 57% in the biota samples.

Llorca et al. (2012b) investigated 18 PFASs in biota and environmental samples (fish, soil, algae, guano and others) from the **Antarctica** and Tierra de Fuego, collected in 2010. The concentrations of PFASs ranged from 0.10 to 240 ng/g for most of the samples except for penguin dung, which presented levels between 95 and 603 ng/g for PFOA. The authors concluded that detection is related to the transport, deposition, biodegradation and bioaccumulation patterns of PFASs. Further research is also needed to clarify the relative importance of hydrological and atmospheric long-range transport as opposed to local pollution in determining PFAS concentrations in the tissues of Antarctic biota.

10.6.6. Screening of PFASs in Nordic countries and the Arctic

With a screening approach it is possible to consider environmental issues on an early stage and such studies should be considered as a first step rather than a comprehensive assessment. Results from a screening study can be used to determine the level of details needed of further environmental studies and direct efforts towards potential risks (Kärrman et al., 2019). A recent, thorough screening study conducted on behalf of the Nordic Screening group (www.nordicscreening.org) including Denmark, Greenland, Finland, Faroe Islands, Norway, Sweden describes the screening of an extensive list of conventional and emerging per- and polyfluoroalkyl substances (PFASs) in the Nordic environment. The study covers in total ninety-nine (99) PFASs and analysis of extractable organic fluorine (EOF). The latter can provide the amount, but not identity, of organofluorine in the samples, which in turn can be used to assess the mass balance between known and unknown PFASs. The aim of the study was to compare PFAS levels between different Nordic locations and also the different PFAS profiles in different matrices from the biotic and abiotic environment. The screening study covered both previously studied PFASs, called “conventional” PFASs, and “novel” PFASs for which environmental data mostly is lacking. A total of ninety-nine (99) substances were analyzed, divided into the following categories:

1. Volatile PFASs (vPFASs)
2. Ultra-short-chain PFASs
3. Perfluoroalkyl carboxylic acids and sulfonic acids (PFCAs and PFSAs)
4. Precursor PFASs
5. Perfluoroalkyl phosphonic and phosphinic acids (PFPA/PFPiAs)
6. Novel PFASs

A total of 102 samples were analyzed in this study, including bird eggs, fish, marine mammals, terrestrial mammals, surface water, WWTP effluents and sludge, and air. Samples were collected by institutes from the participating countries and self-governing areas; Denmark, Faroe Islands, Finland, Greenland, Iceland, Norway, and Sweden. The majority of samples were collected in 2017. PFASs were analyzed using liquid-, supercritical fluid-, and gas chromatography coupled to mass spectrometry. EOF was analyzed using combustion ion chromatography. The PFASs profile in seabird eggs and marine mammals was dominated by the per-fluoroalkyl acids (PFAAs) that are perfluoroalkyl carboxylic acids (PFCAs) and perfluoroalkyl sulfonic acids (PFSAs), and mainly perfluorooctane sulfonic acid (PFOS) and long-chain PFCAs (>C8).

Precursor compounds contributed to the total PFASs in the present study and were frequently detected in many matrices. Several novel PFASs were detected in biota, water and air from Nordic and Arctic Countries in the present study showing the wide distribution and potential for long-range transport of precursors and PFASs.

Biota: Reindeer (*Rangifer tarandus*) and freshwater fish livers from European perch (*Perca fluviatilis*), brown trout (*Salmo trutta*) and Arctic char (*Salvelinus alpinus*) also showed predominating PFCA and PFSA profiles with some minor contribution from PFCA precursor compounds. The total PFAS concentrations in the reindeer samples in descending order were 5.4 ng/g for Greenland, 3.3 ng/g for Sweden, 1.4 ng/g for Finland and 1.1 ng/g for Iceland. The brown bear sample (*Ursus arctos*) from Finland had a total PFAS concentration of 18.9 ng/g. Marine fish livers from Atlantic pollock (*Pollachius pollachius*), Greenland cod (*Gadus ogac*), Atlantic cod (*Gadus morhua*), European flounder (*Platichthys flesus*) and Atlantic herring (*Clupea harengus*), ranged from 10.6 ng/g to 18.2 ng/g. The average of total PFAS concentrations in the freshwater fish samples in descending order were 154 (74.7 – 302) ng/g for perch from Finland, 112 ng/g for perch from Norway, 35.4 (34.7 – 36.2) ng/g for trout and char from Faroe Islands, 24.5 (19.8 – 29.1) ng/g for perch from Denmark, 5.9 (0.30 – 11.47) ng/g for trout from Iceland, and 5.7 (5.2 – 6.2) ng/g for perch from Sweden.

Sludge: Sludge samples were dominated by PFCA precursors, on average accounting for 75% of all identified PFASs, and mainly contributed by different isomers of polyfluoro-alkyl phosphoric acid diesters (diPAPs). The PFASs in the sludge samples, in descending order, were 142 (136 – 149) ng/g for Denmark, 103 (67.8 – 180) ng/g for Sweden, 100 (74.9 – 126) ng/g for Finland, 75.2 (64.1 – 86.2) ng/g for Norway and 36.8 (34.9 – 38.8) ng/g for Faroe Islands. Effluent samples contained a mix of PFAS classes including PFCAs, PFASs, ultra-short PFASs (mainly perfluoropropionic acid, PFPrA) and PFCA precursors. The average total PFAS concentrations in the effluent samples were 113.3 ng/L for Sweden, 75.4 ng/L for Greenland, 55.4 ng/L for Iceland, 49.7 ng/L for Finland, 48.2 ng/L for Denmark, 44.0 ng/L for Norway and 34.2 ng/L for Faroe Islands.

Water: The PFASs in surface water mainly ranged between 1 and 10 ng/L, with one exception of 61 ng/L in Helsinki which could indicate strong influence from point source(s). PFCAs dominated the profile with the highest concentration for PFHxA followed by PFBA.

Air: Air was collected using glass fiber filters (GFF) and PUF/XAD-2/PUF and analysed for conventional PFASs and a suite of novel PFASs. Conventional PFASs detected in air included PFOA, PFBS, PFHxS, and PFOS. Novel PFASs such as 1,3-Bis(trifluoromethyl)-5-bromobenzene BTfBB, and PFECHS was frequently detected although their levels need to be further confirmed.

WWTP: PFECHS was detected in fish liver, marine mammal liver, and also in surface water and WWTP effluent. The target analysis of PFASs could explain between 2% and 102% of the measured EOF. The average explanation degree for detected samples was 8% for surface water, 9% for WWTP sludge, 11% for WWTP effluents, 18% for reindeer, 26% for fresh water fish, 28% for bear, 37% for marine mammals, 42% for marine fish and 68% for bird eggs.

10.6.7. Conclusion

Monitoring studies clearly demonstrate that PFASs are transported over long distances via ocean currents, air, migrating animals and particle binding to the Arctic and Antarctica. Because of non-degradability, the movement of their carriers leads to global drift of PFASs over long distances from the point of release.....

While little information on PFASs in Antarctica is available, new data show a wider range of PFASs in the Arctic since 2009. Several novel PFASs were detected in biota, water and air

from Nordic and Arctic countries showing the wide distribution and potential for long-range transport of precursors and PFASs. Precursor -PFASs contributed to the total PFASs detected in all environmental compartments of remote areas and were frequently detected in many matrices. PFASs new to the monitoring schemes detected include PFECHS (a cyclic analog of PFOS), FBSA (a precursor of PFBS), a series polyfluorinated ether sulfonates including the chlorinated PFOS related compound, 6:2-Cl-PFAES, and cyclic or unsaturated PFASs (review by Muir et al. 2019]. Concentrations of these new substances are not elevated relative to PFOS or most PFCAs, however, particularly in the case of 6:2-Cl-PFAES and FBSA, they are replacement compounds for PFOS-related uses. Novel PFAS frequently detected in air were 1,3-Bis(trifluoromethyl)-5-bromo-benzene (BTFBB), and PFECHS although their levels need to be further confirmed. **Within the Arctic, PFCAs dominated the profile in water with the highest concentration for PFHxA followed by PFBA.** Conventional PFASs detected in Arctic air included PFOA, PFBS, PFHxS, and PFOS. The PFASs profile in Arctic and Antarctic seabird eggs and marine mammals is dominated by the PFAAs, i.e. PFCAs and PFASs, and mainly PFOS, long-chain PFCAs (>C8). For the majority of PFASs no data transport pathways or point sources are available though and thus substantial uncertainties on the concern on the long-range transport potential remain.

10.7. Time trends

In marine predators from Europe, concentrations of PFOS and other PFASs seem to level off in the early 2000s (Huber et al., 2012, Jouanneau et al., 2020, Pereira et al., 2021). Similar trends were observed in terrestrial species (Falk et al., 2019, Falk et al., 2012), whereas increasing PFOS (and PFCA) concentrations were reported for biota living in contaminated regions with slow water exchange such as the Baltic Sea (Sun et al., 2019b, Faxneld et al., 2016, Roos et al., 2013). In compartments with high admixture (i.e. marine compartments with high water exchange), water bound PFASs such as PFOS dilute more rapidly whereas compartments with lower admixture (i.e. freshwater/brackish water) might obscure or delay declining trends of production phase-outs. This also became apparent in a time trends analysis of Baltic cod from Gotland, Sweden, where PFOS as well as long-chain PFCAs (except for PFOA) concentrations increased between 1981 and 2013 (Schultes et al., 2020a). Increasing PFCA trends were furthermore reported in harbour porpoise (*Phocoena phocoena*) liver (1991-2008) from the Baltic and North Sea (Huber et al., 2012). When considering the overall PFASs trends in biota from North America, Europe and Arctic, a comprehensive review by Land et al. (2018)) revealed no clear trend for PFASs including PFOS, its precursor FOSA, and PFHxS, whereas PFDS tended towards increasing trends in mammals and decreasing trends in fish. Similar to PFASs, PFHpA and PFOA did not show clear trend, whereas longer chained PFCAs (PFNA, PFDA, PFUnDA, PFDoDA, PFTTrDA and PFTTeDA) showed increasing or insignificant temporal trends. In summary, the results indicate that phase-outs did not result in declining trends in biota on a global scale yet, likely attributable to the high persistence of the conventionally target and detected PFASs.

Land et al. (2018)) also investigated temporal trends of PFASs in abiotic matrices on a global scale. For example, PFOS and PFOA showed declining trends in surface waters, whereas most studies on sediment cores reported increasing concentrations. Furthermore, PFOA also showed declining trends in various consumer products, whereas concentration in food contact paper increased. Other PFCAs such as PFHpA, PFNA, PFDA and PFUnDA showed declining trends in various products as well, whereas no clear trend was apparent for PFCAs other than PFOA in most surface waters. This pattern was suggested to be related to a high number of coastal water samples that are more likely to be impacted by point pollution. For snow cores from Italy (1991-2006), Land et al. (2018)) identified a significant change point (2004), with

ANNEX XV RESTRICTION REPORT – PFAS IN FIREFIGHTING FOAMS

PFNA, PFDA, PFUnDA showing increasing trends before and PFNA, PFDA showing declining trends after the change point. Significant change points were also observed for sediment cores from China and Canada but no significant trends were observed before or after (Land et al., 2018). Land et al. (2018)) concluded that PFOS and PFOA restriction resulted in decreasing concentrations especially in surface waters with high water exchange, whereas remote areas might have a delayed response to regulatory measures. A recent review by Muir and Miaz (2021)) compiled data on global temporal trends of PFASs in surface waters and reported that C₄-C₁₀ PFASs and C₄-C₁₂ PFCAs were most commonly investigated (83%). The North Sea and Baltic Sea showed higher PFSA and PFCA concentrations compared to other coastal regions and significantly declining trends ΣC₇-C₁₂ PFCAs for only observed during recent years (2015-2017) (Muir and Miaz (2021)). For the Mediterranean Sea, PFOA and PFOS showed significantly declining trends between 2012-2018 (Muir and Miaz, 2021). In Germany, levels of commonly targeted PFASs in suspended particulate matter (SPM) from the main river systems showed declining trends between 2005-2019, whereas the decline was less pronounced when analysing previously non-extractable PFASs using the direct total oxidizable precursors (dTOP) assay (Figure 51, Göckener et al. (2022))). This was particularly true for PFCAs for which conventional target analysis overestimated the annual decline by a factor of 2.4 (vs. 1.6 for PFASs, Figure 51). Furthermore, the results of Göckener et al. (2022)) indicated a shift to PFCA precursors of shorter-chain length over time, which demonstrates the need for analysing a broader set of PFASs for assessing time trends. Changes in PFCA profiles over time (1984-2013) were furthermore reported for sediment cores of the river Rhône (Lyon, France), where even numbered PFCAs were dominant until 2005, and odd chain PFCAs were dominant afterwards (2005-2013) (Mourier et al., 2019). Furthermore, the study of Mourier et al. (2019)) reported increasing ΣPFASs concentrations in the 1990s, whereas concentrations decreased to a plateau during the 2000s.

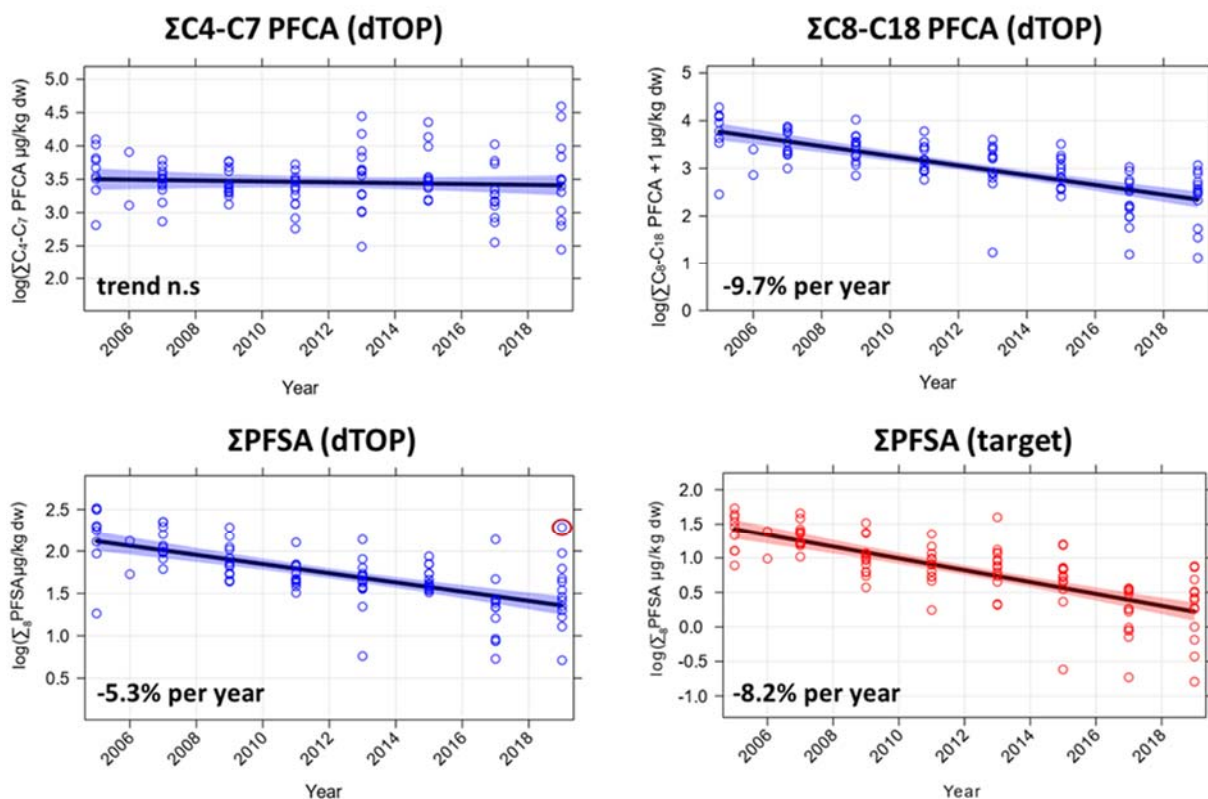

Figure 51. Time trends in percent per year in suspended particulate matter (2005-2019) sampled in the main German rivers and important tributaries (Danube, Elbe,

Mulde, Rhine, Saale, Saar) taken from Gökener et al. (2022)). Samples were analysed by classical target analysis (red) and direct Total Oxidizable Precursor (dTOP) Assay (blue). Trend analysis took variations in river system and total organic carbon content into account. n.s = non-significant trend. The red circle indicates an outlier.

It is important to mention that declining trends of PFAAs in Europe do not mean that concentrations in the environment have decreased. Some PFASs have the potential for long-range transport due to their chemical stability and persistence in various compartments. As a consequence, regulated/replaced PFASs that show declining trends in Europe are not disappearing on a global scale. For example, both PFCAs and PFSAAs have shown to be transported to remote areas such as the Arctic where they are now ubiquitous contaminants (Muir et al., 2019). Especially, volatile PFAA precursors have the potential for long-range transport through atmospheric deposition, which results in increasing PFASs concentrations in the Arctic (Pickard et al., 2018, Muir et al., 2019). For PFOA and long-chain PFCAs, oceanic transport has shown to be most influential for contaminating the Arctic marine environment (Armitage et al., 2009b, Muir et al., 2019). In general, oceanic inflows seems to most influential for PFCAs and PFOS (Armitage et al., 2009a, Muir et al., 2019). However, atmospheric degradation of volatile precursors are important terrestrial PFAS sources in the Arctic and might contribute to oceanic inputs via e.g. melting of glaciers (Muir et al., 2019). As a consequence, oceanic transport but also atmospheric deposition and direct emission sources represent important pathways for contaminating the Arctic environment. For example, PFOS, PFHxS PFNA, PFDA and PFUnA showed increasing trends in polar bears (*Ursus maritimus*) from Greenland when considering a long time series (1984-2006) (Rigét et al., 2013). However, when only considering more recent years (2006-2011), the majority of PFASs show declining trends with only PFOSA being significant (Rigét et al., 2013). Similar to Rigét et al. (2013)), Roos et al. (2021)) reported in Arctic porcupine caribou (*Rangifer tarandus*) a peak PFOS concentration in 2007 with declining trends in one Canadian and three Swedish populations. The majority of PFCAs furthermore showed decreasing trends in Canadian population between 2005-2016 (Roos et al. (2021)). A similar levelling-off of PFOS (and PFHxS) concentrations was observed after 2004 in ringed seals (*Pusa hispida*) from Svalbard but concentrations did not show a clear linear trend (Routti et al., 2016). In contrast, concentrations of PFCAs increased during the study period (1990-2010) but concentrations declined/stabilised when only considering more recent years (2004-2010) (Routti et al., 2016). Declining C₆-C₈ PFSAAs trends after the 3M phase out were also reported for polar bears and Arctic foxes (*Vulpes lagopus*) from Svalbard but exposures remained stable since 2009 which was suggested to be related to atmospheric deposition of volatile PFSA precursors and oceanic transport from Europe and North America (Routti et al., 2017). The latter assumption is supported by the fact that the North Sea (as well as Baltic Sea) has comparably high PFSA and PFCA concentrations (Muir and Miaz, 2021). In contrast to the PFSA results, C₉-C₁₃ PFCAs showed increasing trends in polar bears when considering the whole study period (1997-2014), whereas C₁₂-C₁₄ PFCA concentrations seemed to level-off when only considering recent years (2009-2014) (Routti et al., 2017). Taken together, time-series of Arctic biota samples which include the 1980s/1990s generally show increasing PFOS/PFSA trends but there seems to be a levelling off during the mid-2000s, which becomes apparent when trend analysis only considers more recent years. Similar results were obtained for PFCAs, but the decline of certain PFCAs seems to be delayed and weaker in biota compared to PFOS. For both PFSA and PFCA, ongoing emission from oceanic transport and atmospheric deposition of volatile precursors are suggested to cause ongoing emissions to the Arctic. These examples demonstrate the complexity of PFASs trend assessments even for conventional target analytes. A limitation of the trend analysis is that very limited information is available for the majority of PFASs (including precursors and replacement products), which calls for further

the development and application of novel screening methods such as non-target screening and top assay in future.

However, not only trends for PFAAs are available, trends of volatile and mobile short-chain PFASs (i.e. trifluoroacetic acid (TFA)) are available as well, which show opposite results in Europe compared to the usually targeted PFAAs. TFA is produced between 100-1000 t/a and its entry into terrestrial environments in e.g. Germany was mainly associated with the timing of precipitation events (i.e. higher during summer) rather than the specific location (Freeling et al., 2020). The precipitation-weighted average concentration of TFA was $0.08 \mu\text{g L}^{-1}$ and $0.11 \mu\text{g L}^{-1}$ during 1995-1996 in Germany (Klein, 1997), whereas the concentration during 2018-2019 was 3 to 4 times higher ($0.34 \mu\text{g L}^{-1}$) (Freeling et al., 2020). These results indicate a substantial increase of wet-deposited TFA during the past two decades in the German environment. An even stronger increase was observed for urban landscape waters in Beijing, China, where TFA concentration showed a 17-fold increase between 2002-2012 (Zhai et al., 2015). However, an increase in TFA concentrations was not only observed in abiotic matrices from Germany but also in leaves of European beech (*Fagus sylvatica*) from four locations between 1989-2020 (Figure 52, Freeling and Scheurer (2021)).

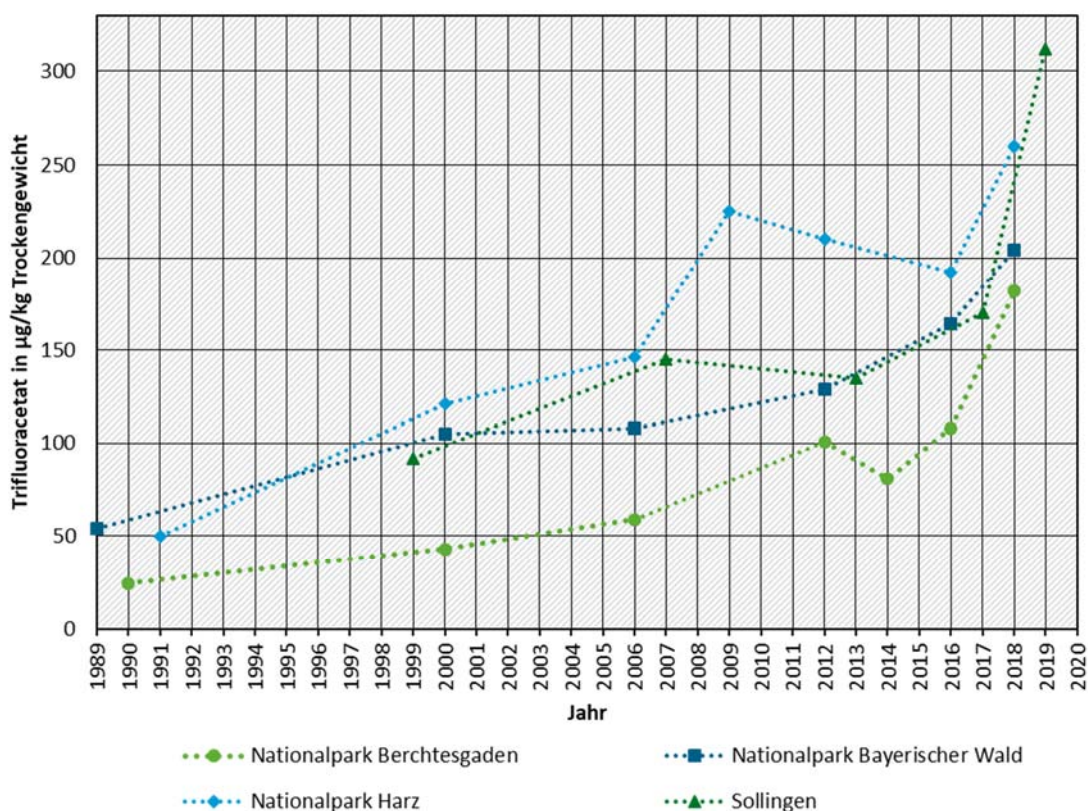

Figure 52. Time trends of trifluoroacetic acid (TFA) in leaves [$\mu\text{g g}^{-1}$ dry weight] of the European beech (*Fagus sylvatica*) from four locations in Germany (taken from Freeling and Scheurer (2021)).

Similar results were obtained for leaves of Lombardy poplar (*Populus nigra*) between 1991-2020, which generally showed higher levels compared to European beech (Freeling and Scheurer, 2021). In coniferous shoots from the European spruce (*Picea abies*), TFA concentrations in 1992 were considerably lower ($43 \mu\text{g g}^{-1}$) compared to those in 2020 ($538 \mu\text{g g}^{-1}$). Similar results were observed in shoots from pines (*Pinus sylvestris*) ($98 \mu\text{g g}^{-1}$ in

1992 and $453 \mu\text{g g}^{-1}$ in 2019) (Freeling and Scheurer, 2021). Based on these results, the authors concluded that TFA concentrations continue to increase in Germany, which may result to an increased exposure to the wider environment including other biota (Freeling and Scheurer, 2021). However, trends of F-gases were not only available for central Europe, also remote areas in Svalbard reported increasing trends in air for the majority of the 13 investigated F-gases (NILU, 2021). The Zeppelin station in Svalbard represents a background site for global climate gas monitoring and is used to study the transport of polluted air episodes. The results demonstrate that four F-gases, namely hydrofluorocarbon (HFC)-125, HCF134a, HFC-152a, and hydrochlorofluorocarbon (HCFC)-141b, which showed increasing trends from 2001-2020 ranging between 0.4–5.19 ppt/year (see Figure 53 for HFC-134a, NILU (2021))).

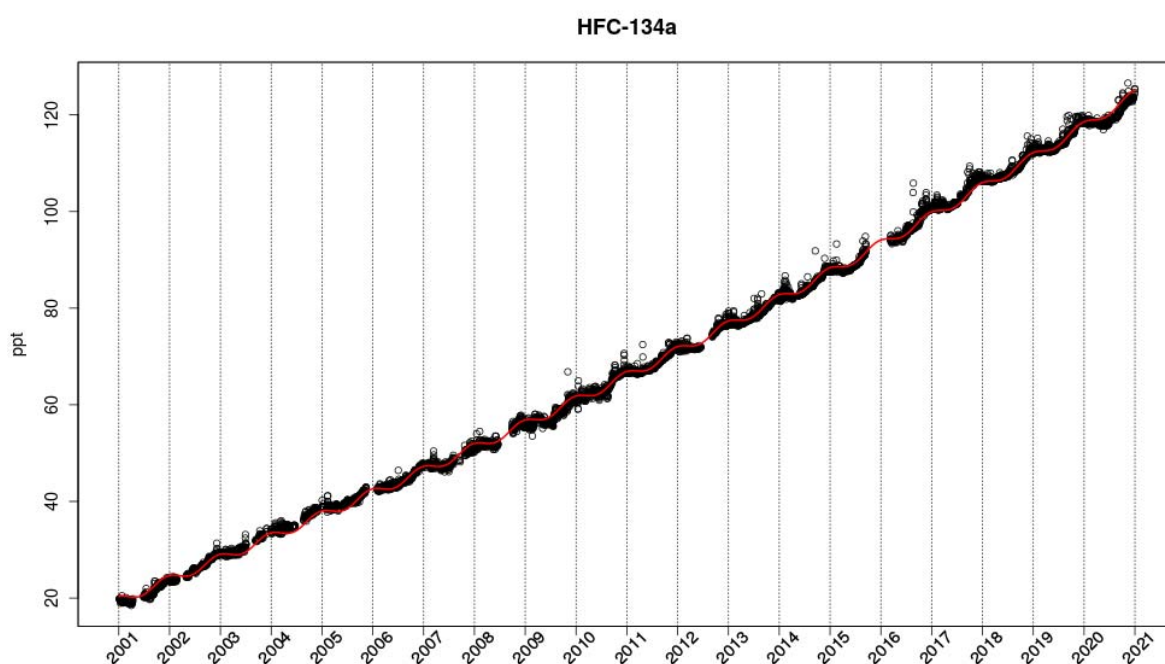

Figure 53. Time trend of HFC-134a (+5.19 ppt per year) in air sampled at the Zeppelin station in Svalbard between 2001-2020 in ppt (taken from NILU (2021)).

The other nine F-gases were analysed between 2010-2020 from which HFC-32, HFC-43-10mee, HFC-143a, HFC-227ea, HFC-236fa, HFC-245fa, HFC365mfc, and HFC-23 showed increasing trends between 0.01-2-31 ppt/year. The only F-gas showing declining trends was HCFC-124 with -0.056 ppt/year between 2010-2020 (NILU, 2021). Taken together, the results available for F-gases demonstrate overall increasing concentrations in air, wet-deposition and plant leaves/shoots from central Europe and remote areas. These results demonstrate that currently applied risk management options are not sufficient to reduce F-gas contamination, which causes a wide-spread environmental contamination.

10.8. Monitoring data on specific PFAS groups

In this section monitoring data are summarised for specific PFAS groups. The data presented are partially overlapping with the data referred to above, but provided to enhance the searchability per PFAS group.

10.8.1. SC-PFCAs, SC-PFSAs and C7-PFCA

SC-PFCAs and SC-PFSAs as well as C7 PFCA are found in surface water from the global oceans, (Ahrens et al., 2010b; Zhao et al., 2012, Kallenborn et al., 2004) as well as rivers (Ahrens et al., 2011b; Takemine et al., 2014) and lakes (Sun et al., 2011; Exner 2016), in effluent, effluent and sludge of WWTPs (Ahrens et al., 2009; Loos et al., 2013; Eriksson et al., 2017), landfill leachates (Busch et al., 2010), groundwater (Eschauzier et al., 2013), soil and sediment (Klif, 2010), tap water and raw water (Llorca et al., 2012a), snow of remote regions (Kirchgeorg et al., 2013), atmosphere (Jahnke et al., 2007), house dust and air (Shoeib et al., 2011).

SC-PFAAs and several precursors have also been detected in the various aquatic and terrestrial organisms from natural (e.g. Llorca et al., 2012b; Routti et al 2017) and rather exposed sites (Ahrens et al 2016; Gebbink et al., 2016; Lam et al., 2014; Lam et al., 2016). PFBS has been detected in deep Arctic waters, and oceans are likely to be the sink (Yamashita 2008).

Of the SC-PFASs, PFBS and PFBA are the dominating PFASs in river and/or sea water in several studies of European waters (Zhao et al. 2015; Möller et al. 2010; Eschauzier et al. 2010). The number of studies and measurements of PFBS in water and other environmental compartments is large. Arp and Slinde (2018) compiled a non-exhaustive list of monitoring data for PFBS in surface water, groundwater, drinking water, wastewater and leachate from landfill.

Concentrations of SC-PFAAs measured in surface water, groundwater and tap-water vary within a wide range in many cases the concentrations are at the low end, or even not detected. However, their ubiquity in water samples shows that they are highly mobile and well distributed in the freshwater environment, even apart from point sources (Ahrens et al., 2010b; Kirchgeorg et al., 2016).

As LC-PFAAs (e.g. PFOA and PFOS and their precursors) are substituted with shorter chain PFAAs (ECHA, 2014; UNEP, 2006), a decrease in environmental concentrations of the former has been observed to be accompanied by an increase in short-chain PFAAs (Shiwaku et al., 2016; Pan et al., 2018), which will very likely increase in the near future. Additionally, even if emissions would now stop, a large mass of fluorinated polymers which already can be expected to be present in the environment will likely act as a future emission source (Wang et al., 2014).

It has been shown for example by Boiteux et al. (2017) or Eriksson and Karrman (2015) that concentrations of PFHxA and its precursors correlate with each other. This further emphasises the importance of precursor substances and their distribution in the environment.

In the light of the high persistence of SC-PFAAs, their high mobility, low adsorption to organic carbon and the difficulty to remove them from water (section B.4.2.2), the concentration of SC-PFAAs will increase if emissions to the environment, also from degradation of precursors, continue.

10.8.2. Cyclic PFAAs

Perfluoro-4-ethylcyclohexanesulfonate (PFECCHS), is cyclic C8-PFSA that is added to aircraft hydraulic fluids as an erosion inhibitor (de Silva et al., 2011). It is not known whether PFECCHS may have been used or is used in other applications. According to UNEP (2011), PFECCHS has been phased out of production by the only known chemical manufacturer.

PFECCHSs have been detected downstream of airports in Canada and China. In Canada, PFECCHS, has been detected in water bodies and amphipods (30.63 ng/g ww), together with several linear PFCAs and PFSAs, close to Ontario airport (de Solla et al., 2012). Although the authors reported that there was no known spill event or publicly reported use of AFFF associated with a fire event at the airport, the airport is the most likely major source of PFAAs.

PFECCHS has been detected in the high Arctic lakes known to be locally contaminated by a small airport in samples from water (4.3 ± 1.4 ng/L lake Meretta), sediment (0.07 ng/g in lake and 0.01 in lake Resolute), juvenile char whole body homogenates (0.80 ± 0.86 ng/g ww in lake Char) and muscle (1.6 ng/g in north lake), and benthic invertebrates (0.32 ± 0.73 ng/g ww in Meretta and 0.29 ± 0.50 ng/g ww in Resolute) (Lescord et al., 2015)

Several isomers of PFECCHS and perfluoropropylcyclopentanesulfonate (PFPCPeS), have been detected, together with several other PFAAs, in all samples downstream Beijing international airport in China, but not upstream (Wang et al., 2016). PFECCHS and PFPCPeS displayed a relatively low detection frequency in sediments (43 and 14% respectively), indicating lower hydrophobicity than linear homologues (PFOA). The lower hydrophobicity of linear PFASs in comparison to cyclic PFASs is underlined by the retention times on C18 columns, which is lower for PFECCHS (11.7 min) than for L-PFOS (12.8 min).

PFECCHS was detected coastal areas of Bohai Bay in China, with concentrations ranging from n.d. to 0.207 ng/L, with a detection frequency of 35% in water and n.d.-0.182 ng/L with a detection frequency of 50% in sediments (Liu et al., 2019). The sources of PFECCHS were attributed to erosion inhibitor factories source based on a positive matrix factorization (PMF) model.

In a study conducted in 2010 by Silva et al., PFECCHS was detected in all surface water samples from the Great Lakes (0.16–5.7 ng L⁻¹) and in all in top predator fish from Lake Ontario and 3 from lake Huron (<MDL to 3.7 ng g⁻¹ wet weight in whole body homogenate) (Silva et al., 2011). PFECCHS has also been detected in tap water samples from 2 source locations from the Great Lakes (1.0 – 1.2 ng/L) (Kaboré et al., 2018).

PFECCHS, together with PFBS, C8 PFOS and PFDS, has also been detected on the Devon Ice Cap (MacInnis et al., 2017). The presence of PFAAs in the ice cap is attributed by the authors to atmospheric deposition due to the high altitude (Devon Ice Cap summit is 1800m above sea level), which source could be the direct emission due to leakage of the compound from aircraft during usage.

In a recent study PFECCHS was detected in 86% of the Baltic Sea coastal water samples but it was below the detection limit in all samples from the German Bight and sediment samples (Joeris et al., 2019). In this study the concentration of PFECCHS showed a weak significant positive correlation to Br-PFOS (Pearson's $r = 0.35$, $p = 0.022$) and L-PFOS (Pearson's $r = 0.49$, $r = 0.0011$). A positive relationship could result from emissions of PFECCHS present as an impurity in POSF-based products. However, PFECCHS levels are in the same range as those of

ΣPFOS, indicating that distinct emissions, for example from hydraulic fluids, can play a role as well.

PFECHS has been recently detected in polar bears, where it was quantifiable at 96% and 88% frequency in liver samples from bears for the Southern (SHB) and Western Hudson Bay (WHB) subpopulations respectively. The concentrations that ranged from 0.406–1.45 ng g⁻¹ ww (SHB) and 0.090–0.296 ng g⁻¹ ww (WHB) (Letcher et al., 2018). The concentration of PFOS in the liver was several orders of magnitude higher (794–1191 ng g⁻¹ww). This low levels could be explained by the lower historical use of PFECHs compared to linear PFAAs.

10.8.3. Ultra-short (C2-C3) PFCAs and PFSAAs

PFAAs with 2 or 3 perfluorinated carbons and their precursors have not been usually included in monitoring studies on PFASs, which could be explained due to analytical limitations. The recent publication by Ateia et al., (2019) contains a non-exhaustive review of the monitoring data on the occurrence of PFAAs, including C2-C3 PFAAs in different water compartments.

Barzen-Hanson and Field (2015) were the first that reported the presence of perfluoropropane sulfonic acid (PFPrS) and pefluoroethane sulfonic acid (PFEtS) in in five 3M AFFFs (each manufactured in 1989, 1998, and 2001 and two formulations from 1993). They also identified the presence of these compounds in all groundwater sample from 11 U.S. military bases (1 sample per base). PFEtS was quantified in 8 of the 11 samples above the limit of detection (0.80 ng/L) from 7.0 to 13 mg/L and comprised 0.22% of the PFSAAs on average. PFPrS was quantified in all samples with concentrations of ranging from 120 to 270 mg/L, which comprised 3.5% of the PFSAAs on average.

The presence of PFPrS and PFEtS in groundwater and surface water from various sites with suspected PFAS contamination was analysed by Ericson Jogsten and Yeung (2017). PFEtS was detected in all sites (n=26) above the method detection limit (0.06 ng//L) in a concentration range of 0.07 to 5 700 ng/L, while PFPrS was detected in 22 out of 26 samples with concentrations ranging from below the method detection limit (0.43 ng//L) up to 39 000 ng/L. The contribution of PFPrS varies in the samples from 0.4% to 17%. Concentrations of ultra-short-chain compounds were in the low ng/L range in a limited number of background samples included in the study.

Ultra-short-chain PFAAs were detected in all samples collected Sweden in connection with firefighting training sites, landfills, and a hazardous waste management facility at concentrations up to 84 000 ng/L (ΣC1–C3), representing up to 69% of the concentration of 29 per- and polyfluoroalkyl substances (PFASs) (Björnsdotter et al., 2019). These findings reveal the presence of high concentrations of ultra-short-chain PFAAs released into the environment from various sources and emphasize the large fraction of ultra-short-chain PFAAs to the total concentration of PFASs in water (Björnsdotter et al., 2019).

The occurrence of ultra-short PFAAs (PFEtS, PFPrS and prefluoropropanoic acid PFPrA) in the Nordic environment was also investigated by Kärman et al., (2019). C2-C3 PFAAs were detected in all WWTP effluent (dissolved + particle pase) samples (n=14, average concentration 11.0 ng/L, range 1.4 - 48.2 ng/L) The ultra-short PFASs accounted for 6% of the total PFASs concentration in the samples from Finland, Sweden, Denmark, Norway, and Faroe Islands. In Greenland and Norway they were the most abundant class of PFASs with mean contribution of 39%. The ultra-short PFAAs were also present in 11 from the 13 surface water samples. C2-C3 PFAAs were not detected in any of the biota samples in the study. Ultra-short PFASs were not detected in any of the aquatic and terrestrial organisms included

in the study. According to the authors, the data on ultra-short PFAAs should be considered as semiquantitative due to the challenges associated to the analysis.

PFETs have been detected in tap water samples from China, Japan, Canada and the United States, being the most predominant PFASs in the tap water from Xiamen and Beijing (0.90 ng/L; Mac et al. 2000), while PFPrS was only detected in samples from one location in Japan.

Ultra-short PFASs (i.e., C2 and C3) accounted for over 40% of the detectable PFASs in the rain samples (n=2) collected in Toronto (Yeung et al. 2017).

10.8.4. PFPAs

PFPAs have been included only in a limited number of studies on occurrence of PFASs, where they have been detected at lower levels and detection frequencies than PFCAs and PFSAs (Wang et al., 2016; Xiao et al. 2017). PFPAs have been detected in surface water in Germany (Llorca et al., 2012); Netherlands (Esparza et al. 2011), Japan (Zushi et al., 2011), China (Jin et al., 2015) and Canada (D'eon et al., 2009; Sanchez et al., 2015). The lower concentrations and detection frequencies could be explained by a lower global historical use and releases of these substances compared to PFCAs and PFSAs (Wang et al., 2016).

10.8.5. PFECAs and PFESAs

HFPO-DA was found in surface waterbodies in Europe, including the marine environment (Heydebreck et al., 2015, Heydebreck, 2017; Pan et al., 2018), US (Sun et al., 2016; Van Poll, 2018) and China (Pan et al. 2017). HFPO-DA was also found in tap water in Netherlands (Gebink et al., 2017; Brandsma et al., 2019).

ADONA was found only in the Rhine River but not in other surface waterbodies in Europe, US and China (Pan et al., 2018) and in plasma of German blood donors (Froome et al., 2017). It was not detected in water and biological samples (egg birds, fish and marine and terrestrial mammals) from the Nordic environment (Kärman et al., 2019).

Several PFCEAs (in addition to HPFOA-DA) have been detected in the Cape Fear River in US downstream a fluorochemical manufacturer plant (Strynar et al., 2015; Sun et al., 2016) where a sulfonated tetrafluoroethylene based fluoropolymer-copolymer was produced. Due to the lack of authentic standards, the concentration of these PFECAs could not be quantified. Based on the comparison of chromatographic peak areas Sun et al., (2016) determined that the dominant PFECA was perfluoro-2-methoxyacetic acid (PFMOAA), with a peak area ~100 times that of HPFO-DA, followed by perfluoro-3,5-dioxahexanoic acid (PFO2HxA; peak area ~25 times that of HPFO-DA) and perfluoro-3,5,7-trioxaoctanoic acid (PFO3OA; peak area ~5 times that of HPFO-DA). Hopkins et al., (2018) estimated the added concentration of PFCAs in the Cape Fear River to be 40,000 ng/L with contributions from PFMOAA (CAS 674-13-5) >> PFO2HxA (CAS 39492-88-1) > PFO3OA (CAS 39492-89-2) ~GenX > Nafion byproduct 2 (CAS 749836-20-2) > PFO4DA (CAS 39492-90-5). When the manufacturer began to capture process wastewater containing GenX, the sum concentration of targeted PFEAs in the river dropped sharply to an estimated concentration of approximately 4,200 ng/L.

Song et al. (2018) identified the presence in the Xiaoqing River, which receives water discharge from one of the major fluoropolymer manufacturing facilities in China 42 PFASs, including 3 HPFO oligomers (dimer acid, DA; trimer acid, TA and tetramer acid, TeA) and numerous tentatively detected isomers of C9–C14 PFECAs. The water concentrations of HFPO-TrA (<LOQ-7.82×10⁴ng/L) and HFPO–DA (<LOQ-9.35×10³ng/L) were approximately

ANNEX XV RESTRICTION REPORT – PFAS IN FIREFIGHTING FOAMS

1 and 2 orders of magnitude lower than the concentrations of PFOA. C4, C6, and C8 PFASs and C8 Cl-PFESA were also detected although the concentrations were 1–4 orders of magnitude lower than PFCAs and HFPO oligomers. HFPO-TeA was quantified for the first time in environmental samples with sediment concentrations ranging from < LOQ to 42.6 ng/g dw in 2014 and < LOQ to 363 ng/g in 2016.

China is the only known emission source of 6:2 Cl-PFESA (major component of F-53B), where it is ubiquitously present in the environment (Pan et al. 2018). In addition, 6:2 Cl-PFESA has been detected in trace levels (median = 0.031 ng/L, range = 0.010–0.38 ng/L) in surface water samples outside China, including UK, Sweden and Germany (Pan et al., 2018) and in 34 out of 34 samples in Greenland marine mammals (mean values of 0.0045 ng/g in ringed seal, 0.27 ng/g in polar bear and 0.023 ng/g in killer whale; Gebbink et al., 2016). These data strongly suggest that 6:2 Cl-PFESA can undergo long-range transport to the Arctic and has the potential for global distribution. A non-exhaustive review of the environmental occurrence of fluoroalkyl ether substances, including F-53B (6:2 Cl-PFAES) has been recently published by Munoz et al., (2019).

References

- 2010/75/EU 2010. Directive 2010/75/EU of the European Parliament and of the Council of 24 November 2010 on industrial emissions (integrated pollution prevention and control) Text with EEA relevance.
- AAS, C. B., FUGLEI, E., HERZKE, D., YOCCOZ, N. G. & ROUTTI, H. 2014. Effect of body condition on tissue distribution of perfluoroalkyl substances (PFASs) in Arctic fox (*Vulpes lagopus*). *Environmental Science and Technology*, 48, 11654-11661.
- AHRENS, L. 2011. Polyfluoroalkyl compounds in the aquatic environment: A review of their occurrence and fate. *Journal of Environmental Monitoring*, 13, 20-31.
- AHRENS, L., GERWINSKI, W., THEOBALD, N. & EBINGHAUS, R. 2010. Sources of polyfluoroalkyl compounds in the North Sea, Baltic Sea and Norwegian Sea: Evidence from their spatial distribution in surface water. *Mar. Pollut. Bull.*, 60, 255.
- AHRENS, L., HARNER, T., SHOEIB, M., KOBIZKOVA, M. & REINER, E. J. 2013. Characterization of two passive air samplers for per- and polyfluoroalkyl substances. *Environmental Science and Technology*, 47, 14024-14033.
- AHRENS, L., NORSTRÖM, K., VIKTOR, T., COUSINS, A. P. & JOSEFSSON, S. 2015. Stockholm Arlanda Airport as a source of per- and polyfluoroalkyl substances to water, sediment and fish. *Chemosphere*, 129, 33-38.
- AHRENS, L., SHOEIB, M., DEL VENTO, S., CODLING, G. & HALSALL, C. 2011a. Polyfluoroalkyl compounds in the Canadian Arctic atmosphere. *Environmental Chemistry*, 8, 399-406.
- AHRENS, L., SHOEIB, M., HARNER, T., LEE, S. C., GUO, R. & REINER, E. J. 2011b. Wastewater treatment plant and landfills as sources of polyfluoroalkyl compounds to the atmosphere. *Environmental Science and Technology*, 45, 8098-8105.
- AMAP 2014. ArcRisk (arctic health risks: impacts on health in the arctic and Europe owing to climate-induced changes in contaminant cycling) results overview. *Arctic Monitoring and Assessment Program Oslo*, 62.
- AMT DER VORARLBERGER LANDESREGIERUNG 2016. Klärschlamm und Boden: Eintrag von Spurenstoffen auf landwirtschaftlich genützte Böden. Clara, M., Hartmann, C., Scheffknecht, C., Bregenz and Wien.
- AMT DER VORARLBERGER LANDESREGIERUNG 2017. Untersuchung ausgewählter prioritärer und sonstiger Stoffe in kommunalen Kläranlagen und Fließgewässern in Vorarlberg. Clara, M., Hane-feld, W., Scheffknecht, C., Bregenz, Österreich.
- ANALYTIK, B. 2019. Modellvorhaben Eignungsprüfung und Optimierung von Verfahren zur Reinigung von PFC-Grundwasserkontaminationen.
- ANDERSON, J. Biodegradable cleaning agent for PFAS-impacted infrastructure. Emerging Contaminants in the Environment Conference (ECEC21), 2021.
- ANDROULAKAKIS, A., ALYGIZAKIS, N., GKOTSIS, G., NIKA, M.-C., NIKOLOPOULOU, V., BIZANI, E., CHADWICK, E., CINCINELLI, A., CLAËN, D., DANIELSSON, S., DEKKER, R. W. R. J., DUKE, G., GLOWACKA, N., JANSMAN, H. A. H., KRONE, O., MARTELLINI, T., MOVALLI, P., PERSSON, S., ROOS, A., O'ROURKE, E., SIEBERT, U., TREU, G., WALKER, L. A., SLOBODNIK, J. & THOMAIDIS, N. S. 2022. Determination of 56 per-

ANNEX XV RESTRICTION REPORT – PFAS IN FIREFIGHTING FOAMS

and polyfluoroalkyl substances in top predators and their prey from Northern Europe by LC-MS/MS. *Chemosphere*, 131775.

ARCADIS 2019. First time use of ozofractionation to treat AFFF release and validation by TOP assay - presentation at the NEWEA 2019 annual conferenc. Retrieved from http://www.newea.org/wp-content/uploads/2019/02/AC19_JMcDonough_26.pdf.

ARMITAGE, J. M., ARNOT, J. A. & WANIA, F. 2012. Potential Role of Phospholipids in Determining the Internal Tissue Distribution of Perfluoroalkyl Acids in Biota. *Environmental Science & Technology*, 46, 12285-12286.

ARMITAGE, J. M., MACLEOD, M. & COUSINS, I. T. 2009a. Comparative Assessment of the Global Fate and Transport Pathways of Long-Chain Perfluorocarboxylic Acids (PFCAs) and Perfluorocarboxylates (PFCs) Emitted from Direct Sources. *Environmental Science & Technology*, 43, 5830-5836.

ARMITAGE, J. M., MACLEOD, M. & COUSINS, I. T. 2009b. Modeling the Global Fate and Transport of Perfluorooctanoic Acid (PFOA) and Perfluorooctanoate (PFO) Emitted from Direct Sources Using a Multispecies Mass Balance Model. *Environmental Science & Technology*, 43, 1134-1140.

ARO, R., ERIKSSON, U., KÄRRMAN, A., CHEN, F., WANG, T. & YEUNG, L. W. Y. 2021. Fluorine Mass Balance Analysis of Effluent and Sludge from Nordic Countries. *ACS ES&T Water*, 1, 2087-2096.

ARVANITI, O. S., ANDERSEN, H. R., THOMAIDIS, N. S. & STASINAKIS, A. S. 2014. Sorption of Perfluorinated Compounds onto different types of sewage sludge and assessment of its importance during wastewater treatment. *Chemosphere*, 111, 405-411.

ARVANITI, O. S., VENTOURI, E. I., STASINAKIS, A. S. & THOMAIDIS, N. S. 2012. Occurrence of different classes of perfluorinated compounds in Greek wastewater treatment plants and determination of their solid-water distribution coefficients. *J Hazard Mater*, 239-240, 24-31.

AU-EPA 2021. Firefighting Foam Policy Waste disposal plan advisory.

BADRY, A., TREU, G., GKOTSIS, G., NIKA, M.-C., ALYGIZAKIS, N., THOMAIDIS, N. S., VOIGT, C. C. & KRONE, O. 2022. Ecological and spatial variations of legacy and emerging contaminants in white-tailed sea eagles from Germany: Implications for prioritisation and future risk management. *Environment International*, 158, 106934.

BADUEL, C., MUELLER, J. F., ROTANDER, A., CORFIELD, J. & GOMEZ-RAMOS, M. J. 2017. Discovery of novel per- and polyfluoroalkyl substances (PFASs) at a fire fighting training ground and preliminary investigation of their fate and mobility. *Chemosphere*, 185, 1030-1038.

BAO, J., LI, C. L., LIU, Y., WANG, X., YU, W. J., LIU, Z. Q., SHAO, L. X. & JIN, Y. H. 2020. Bioaccumulation of perfluoroalkyl substances in greenhouse vegetables with long-term groundwater irrigation near fluorochemical plants in Fuxin, China. *Environmental Research*, 188.

BAO, J., YU, W. J., LIU, Y., WANG, X., JIN, Y. H. & DONG, G. H. 2019. Perfluoroalkyl substances in groundwater and home-produced vegetables and eggs around a fluorochemical industrial park in China. *Ecotoxicology and Environmental Safety*, 171, 199-205.

BARRECA, S., BUSETTO, M., VITELLI, M., COLZANI, L., CLERICI, L. & DELLAVEDOVA, P. 2018. Online Solid-Phase Extraction LC-MS/MS: A Rapid and Valid Method for the

ANNEX XV RESTRICTION REPORT – PFAS IN FIREFIGHTING FOAMS

Determination of Perfluorinated Compounds at Sub ng·L⁻¹ Level in Natural Water. *Journal of Chemistry*, 2018.

- BARRETT, H., DU, X., HOUDE, M., LAIR, S., VERREAULT, J. & PENG, H. 2021. Suspect and Nontarget Screening Revealed Class-Specific Temporal Trends (2000–2017) of Poly- and Perfluoroalkyl Substances in St. Lawrence Beluga Whales. *Environmental Science & Technology*, 55, 1659-1671.
- BENGTSON NASH, S., RINTOUL, S. R., KAWAGUCHI, S., STANILAND, I., HOFF, J. V. D., TIERNEY, M. & BOSSI, R. 2010. Perfluorinated compounds in the Antarctic region: Ocean circulation provides prolonged protection from distant sources. *Environmental Pollution*, 158, 2985-2991.
- BERTRAND, O. R., HALSALL, C. J., HERZKE, D., HUBER, S., NORDSTAD, T., DEL VENTO, S. & HEIMSTAD, E. S. 2014. Short-term fluctuations in the levels of poly- and perfluoroalkyl Substances (PFASs) in the seasonal Snowpack. *Arctic Frontiers*.
- BISCHEL, H. N., MACMANUS-SPENCER, L. A., ZHANG, C. & LUTHY, R. G. 2011. Strong associations of short-chain perfluoroalkyl acids with serum albumin and investigation of binding mechanisms. *Environmental Toxicology and Chemistry*, 30, 2423-2430.
- BJÖRNSDOTTER, M. K., YEUNG, L. W. Y., KÄRRMAN, A. & ERICSON JOGSTEN, I. 2020. Challenges in the analytical determination of ultra-short-chain perfluoroalkyl acids and implications for environmental and human health. *Analytical and Bioanalytical Chemistry*, 412, 4785-4796.
- BLAINE, A. C., RICH, C. D., SEDLACKO, E. M., HUNDAL, L. S., KUMAR, K., LAU, C., MILLS, M. A., HARRIS, K. M. & HIGGINS, C. P. 2014. Perfluoroalkyl acid distribution in various plant compartments of edible crops grown in biosolids-amended soils. *Environmental Science and Technology*, 48, 7858-7865.
- BOITEUX, V., BACH, C., SAGRES, V., HEMARD, J., COLIN, A., ROSIN, C., MUNOZ, J. F. & DAUCHY, X. 2016. Analysis of 29 per- and polyfluorinated compounds in water, sediment, soil and sludge by liquid chromatography–tandem mass spectrometry. *International Journal of Environmental Analytical Chemistry*, 96, 705-728.
- BOITEUX, V., DAUCHY, X., ROSIN, C. & BOITEUX, J. F. V. 2012. National screening study on 10 perfluorinated compounds in raw and treated tap water in France. *Archives of Environmental Contamination and Toxicology*, 63, 1-12.
- BOONE, J. S., VIGO, C., BOONE, T., BYRNE, C., FERRARIO, J., BENSON, R., DONOHUE, J., SIMMONS, J. E., KOLPIN, D. W., FURLONG, E. T. & GLASSMEYER, S. T. 2019. Per- and polyfluoroalkyl substances in source and treated drinking waters of the United States. *Science of the Total Environment*, 653, 359-369.
- BOSSI, R., DAM, M. & RIGÉT, F. F. 2015. Perfluorinated alkyl substances (PFAS) in terrestrial environments in Greenland and Faroe Islands. *Chemosphere*, 129, 164-169.
- BOSSI, R., STRAND, J., SORTKJÆR, O. & LARSEN, M. M. 2008. Perfluoroalkyl compounds in Danish wastewater treatment plants and aquatic environments. *Environment International*, 34, 443-450.
- BOSSI, R., VORKAMP, K. & SKOV, H. 2016. Concentrations of organochlorine pesticides, polybrominated diphenyl ethers and perfluorinated compounds in the atmosphere of North Greenland. *Environmental Pollution*, 217, 4-10.

ANNEX XV RESTRICTION REPORT – PFAS IN FIREFIGHTING FOAMS

- BRANDSMA, S. H., KOEKKOEK, J. C., VAN VELZEN, M. J. M. & DE BOER, J. 2019. The PFOA substitute GenX detected in the environment near a fluoropolymer manufacturing plant in the Netherlands. *Chemosphere*, 220, 493-500.
- BRAUNE, B. M., GASTON, A. J., ELLIOTT, K. H., PROVENCHER, J. F., WOO, K. J., CHAMBELLANT, M., FERGUSON, S. H. & LETCHER, R. J. 2014a. Organohalogen contaminants and total mercury in forage fish preyed upon by thick-billed murrelets in northern Hudson Bay. *Marine Pollution Bulletin*, 78, 258-266.
- BRAUNE, B. M., GASTON, A. J., LETCHER, R. J., GRANT GILCHRIST, H., MALLORY, M. L. & PROVENCHER, J. F. 2014b. A geographical comparison of chlorinated, brominated and fluorinated compounds in seabirds breeding in the eastern Canadian Arctic. *Environmental Research*, 134, 46-56.
- BRÄUNIG, J., BADUEL, C., BARNES, C. M. & MUELLER, J. F. 2019. Leaching and bioavailability of selected perfluoroalkyl acids (PFAAs) from soil contaminated by firefighting activities. *Science of the Total Environment*, 646, 471-479.
- BRENDEL, S., FETTER, É., STAUDE, C., VIERKE, L. & BIEGEL-ENGLER, A. 2018. Short-chain perfluoroalkyl acids: environmental concerns and a regulatory strategy under REACH. *Environmental Sciences Europe*, 30.
- BRUELLER, W., INREITER, N., BOEGL, T., RUBASCH, M., SANER, S., HUMER, F., MOCHE, W., SCHUHMAN, A., HARTL, W., BREZINKA, C., WILDT, L. & ALLERBERGER, F. 2018. Occurrence of chemicals with known or suspected endocrine disrupting activity in drinking water, groundwater and surface water, Austria 2017/2018. *Bodenkultur*, 69, 155-173.
- BRUSSEAU, M. L., ANDERSON, R. H. & GUO, B. 2020. PFAS concentrations in soils: Background levels versus contaminated sites. *Science of The Total Environment*, 740, 140017.
- BUCK, R. C., FRANKLIN, J., BERGER, U., CONDER, J. M., COUSINS, I. T., VOOGT, P. D., JENSEN, A. A., KANNAN, K., MABURY, S. A. & VAN LEEUWEN, S. P. J. 2011. Perfluoroalkyl and polyfluoroalkyl substances in the environment: Terminology, classification, and origins. *Integrated Environmental Assessment and Management*, 7, 513-541.
- BUNDESMINISTERIUM FÜR LAND- UND FORSTWIRTSCHAFT. UMWELT UND WASSERWIRTSCHAFT 2016. Deponiesickerwasser – Untersuchungen zu Zusammensetzung, Abbaubarkeit und Hemmwirkung in biologischen Kläranlagen. Bundesministerium für Land- und Forstwirtschaft, Umwelt und Wasserwirtschaft, Wien.
- BUNDESMINISTERIUM FÜR LAND- UND FORSTWIRTSCHAFT. UMWELT UND WASSERWIRTSCHAFT 2017. Emissionen ausgewählter prioritärer und sonstiger Stoffe aus kommunalen Kläranlagen. Bundesministerium für Land- und Forstwirtschaft, Umwelt und Wasserwirtschaft. Wien.
- BUNDESMINISTERIUM FÜR LANDWIRTSCHAFT, R. U. T. 2020. TEMPEST - Erfassung von Emissionen ausgewählter Spurenstoffe aus Kanalsystemen, Handlungsoptionen zu deren Minderung und Optimierung einer alternativen Nachweismethode für Kunststoffpartikel in Wasserproben. Bundesministerium für Landwirtschaft, Regionen und Tourismus, Wien.
- BUNDESMINISTERIUM FÜR NACHHALTIGKEIT UND TOURISMUS 2019. STOBIMO Spurenstoffe - Stoffbilanzmodellierung für Spurenstoffe auf Einzugsgebietebene. Bundesministerium für Nachhaltigkeit und Tourismus, Wien.

ANNEX XV RESTRICTION REPORT – PFAS IN FIREFIGHTING FOAMS

- BUSCH, J., AHRENS, L., XIE, Z., STURM, R. & EBINGHAUS, R. 2010. Polyfluoroalkyl compounds in the East Greenland Arctic Ocean. *J. Environ. Monit.*, 12, 1242.
- BUTT, C. M., BERGER, U., BOSSI, R. & TOMY, G. T. 2010. Levels and trends of poly- and perfluorinated compounds in the arctic environment. *Science of the Total Environment*, 408, 2936-2965.
- BUTT, C. M., MUIR, D. C. G. & MABURY, S. A. 2014. Biotransformation pathways of fluorotelomer-based polyfluoroalkyl substances: A review. *Environmental Toxicology and Chemistry*, 33, 243-267.
- CA-EPA 2021. Aqueous film-forming foam and the Prohibition of Certain Toxic Substances Regulations. Environment and Climate Change Canada.
- CAI, M., ZHAO, Z., YIN, Z., AHRENS, L., HUANG, P., CAI, M., YANG, H., HE, J., STURM, R., EBINGHAUS, R. & XIE, Z. 2012. Occurrence of perfluoroalkyl compounds in surface waters from the North Pacific to the Arctic Ocean. *Environmental Science and Technology*, 46, 661-668.
- CAMPO, J., MASIÁ, A., PICÓ, Y., FARRÉ, M. & BARCELÓ, D. 2014. Distribution and fate of perfluoroalkyl substances in Mediterranean Spanish sewage treatment plants. *Science of The Total Environment*, 472, 912-922.
- CASSON, R. & CHIANG, S. Y. D. 2018. Integrating total oxidizable precursor assay data to evaluate fate and transport of PFASs. *Remediation*, 28, 71-87.
- CEMEX 2013. Examining the use of Fluorspar in the Cement industry.
- CEWEP 2018. Waste to Energy in Europe in 2018.
- CHEN, H., YAO, Y., ZHAO, Z., WANG, Y., WANG, Q., REN, C., WANG, B., SUN, H., ALDER, A. C. & KANNAN, K. 2018. Multimedia Distribution and Transfer of Per- and Polyfluoroalkyl Substances (PFASs) Surrounding Two Fluorochemical Manufacturing Facilities in Fuxin, China. *Environmental Science and Technology*, 52, 8263-8271.
- CHEN, Y., FU, J., YE, T., LI, X., GAO, K., XUE, Q., LV, J., ZHANG, A. & FU, J. 2021. Occurrence, profiles, and ecotoxicity of poly- and perfluoroalkyl substances and their alternatives in global apex predators: A critical review. *Journal of Environmental Sciences*, 109, 219-236.
- CLM-BREF 2013. Production of Cement, Lime and Magnesium Oxide.
- COMAH Buncefield: Why did it happen? The underlying causes of the explosion and fire at the Buncefield oil storage depot, Hemel Hempstead, Hertfordshire on 11 December 2005. Retrieved from <https://www.hse.gov.uk/comah/buncefield/buncefield-report.pdf>.
- CONCAWE 2020. Review of water treatment systems for PFAS removal.
- COOPER, B. J. 2014. Considerations for Dealing with Spent Potlining.
- CORNELSEN-INTERVIEW 2021. Interview with Martin Cornelesen concerning ECHA FWC: PFAS in AFFF, SR 4 waste disposal, and cleaning techniques. . In: SCHÖPEL, M. (ed.).
- CORNELSEN 2020. Purification of Highly Contaminated Fire Fighting Water and Decontamination of Fire Vehicles from PFAS in the Transition Process to Fluorine Free Foams. *LASTFIRE Webinar*. Cornelsen Umwelttechnologie GmbH.

ANNEX XV RESTRICTION REPORT – PFAS IN FIREFIGHTING FOAMS

- CORNELSEN, M. 2021. [GERMAN] Reinigung von PFC belasteten Feuerlöschwässern, Einsatzfahrzeugen und Feuerlöschschrüstungen mit dem PerfluorAd-Verfahren.
- COUSINS, I. T., GOLDENMAN, G., HERZKE, D., LOHMANN, R., MILLER, M., NG, C. A., PATTON, S., SCHERINGER, M., TRIER, X., VIERKE, L., WANG, Z. & DEWITT, J. C. 2019. The concept of essential use for determining when uses of PFASs can be phased out. *Environmental Science: Processes and Impacts*, 21, 1803-1815.
- DALAHMEH, S., TIRGANI, S., KOMAKECH, A. J., NIWAGABA, C. B. & AHRENS, L. 2018. Per- and polyfluoroalkyl substances (PFASs) in water, soil and plants in wetlands and agricultural areas in Kampala, Uganda. *Science of the Total Environment*, 631-632, 660-667.
- DAUCHY, X., BOITEUX, V., BACH, C., COLIN, A., HEMARD, J., ROSIN, C. & MUNOZ, J.-F. 2017a. Mass flows and fate of per- and polyfluoroalkyl substances (PFASs) in the wastewater treatment plant of a fluorochemical manufacturing facility. *Science of The Total Environment*, 576, 549-558.
- DAUCHY, X., BOITEUX, V., BACH, C., ROSIN, C. & MUNOZ, J. F. 2017b. Per- and polyfluoroalkyl substances in firefighting foam concentrates and water samples collected near sites impacted by the use of these foams. *Chemosphere*, 183, 53-61.
- DAUCHY, X., BOITEUX, V., COLIN, A., BACH, C., ROSIN, C. & MUNOZ, J.-F. 2019. Poly- and Perfluoroalkyl Substances in Runoff Water and Wastewater Sampled at a Firefighter Training Area. *Archives of Environmental Contamination and Toxicology*, 76, 206–215.
- DAUCHY, X., BOITEUX, V., COLIN, A., HEMARD, J., BACH, C., ROSIN, C. & MUNOZ, J. F. 2018. Deep seepage of per- and polyfluoroalkyl substances through the soil of a firefighter training site and subsequent groundwater contamination. *Chemosphere*, 214, 729-737.
- DAUWE, T., VAN DE VIJVER, K., DE COEN, W. & EENS, M. 2007. PFOS levels in the blood and liver of a small insectivorous songbird near a fluorochemical plant. *Environment International*, 33, 357-361.
- DE SILVA, A. O., ARMITAGE, J. M., BRUTON, T. A., DASSUNCAO, C., HEIGER-BERNAYS, W., HU, X. C., KÄRRMAN, A., KELLY, B., NG, C., ROBUCK, A., SUN, M., WEBSTER, T. F. & SUNDERLAND, E. M. 2021. PFAS Exposure Pathways for Humans and Wildlife: A Synthesis of Current Knowledge and Key Gaps in Understanding. *Environmental Toxicology and Chemistry*, 40, 631-657.
- DEATH, C., BELL, C., CHAMPNESS, D., MILNE, C., REICHMAN, S. & HAGEN, T. 2021. Per- and polyfluoroalkyl substances (PFAS) in livestock and game species: A review. *Science of The Total Environment*, 774, 144795.
- DEL VENTO, S., HALSALL, C., GIOIA, R., JONES, K. & DACHS, J. 2012. Volatile per- and polyfluoroalkyl compounds in the remote atmosphere of the western Antarctic Peninsula: An indirect source of perfluoroalkyl acids to Antarctic waters? *Atmospheric Pollution Research*, 3, 450-455.
- DK-EPA 2019. Belysning af destruktion af visse POP-stoffer på konventionelle affaldsforbrændingsanlæg til forbrænding af hovedsageligt ikke-farligt og forbrændingseget affald.
- DOD-AUS 2020a. The Aircraft Rescue & Firefighting (ARFF) foam transition project - overview. *ARFF Vehicle Foam Transition Project - Journey Map.pdf*.

ANNEX XV RESTRICTION REPORT – PFAS IN FIREFIGHTING FOAMS

- DOD-AUS 2020b. Firefighting vehicle cleaning procedure.
- DOD-AUS 2020c. Transition Plan. *ARFF Vehicle Foam Transition Project - Journey Map.pdf*.
- DOMINGO, J. L. 2012. Health risks of dietary exposure to perfluorinated compounds. *Environment International*, 40, 187-95.
- DOMINGO, J. L. & NADAL, M. 2017. Per- and polyfluoroalkyl substances (PFASs) in food and human dietary intake: A review of the recent scientific literature. *Journal of Agricultural and Food Chemistry*, 65, 533-543.
- DREYER, A. & EBINGHAUS, R. 2009. Polyfluorinated compounds in ambient air from ship- and land-based measurements in northern Germany. *Atmospheric Environment*, 43, 1527-1535.
- DUPONT 2020. TECHNICAL GUIDANCE FOR REMOVAL OF PFAS USING ION EXCHANGE RESINS
- DUS-VALENTIN-INTERVIEW 2021. Interview with Ingo Valentin and Jutta Rüber concerning ECHA FWC: PFAS in AFFF, SR 4 waste disposal, and cleaning techniques. *In: SCHÖPEL, M. (ed.)*.
- ECHA 2021. SEAC's approach to assessing changes in producer surplus. Agreed at SEAC-52 on 15 September 2021. Helsinki: European Chemicals Agency.
- ELLIS, D. A., MARTIN, J. W., DE SILVA, A. O., MABURY, S. A., HURLEY, M. D., SULBAEK ANDERSEN, M. P. & WALLINGTON, T. J. 2004. Degradation of fluorotelomer alcohols: A likely atmospheric source of perfluorinated carboxylic acids. *Environmental Science and Technology*, 38, 3316-3321.
- EQUINOR-YSTANES-INTERVIEW 2021. Interview with Lars Ystanes concerning ECHA FWC: PFAS in AFFF, SR 4 waste disposal, and cleaning techniques. *In: SCHÖPEL, M. (ed.)*.
- ERIKSSON, U., HAGLUND, P. & KÄRRMAN, A. 2017. Contribution of precursor compounds to the release of per- and polyfluoroalkyl substances (PFASs) from waste water treatment plants (WWTPs). *Journal of Environmental Sciences*, 61, 80-90.
- ERIKSSON, U., KÄRRMAN, A., ROTANDER, A., MIKKELSEN, B. & DAM, M. 2013. Perfluoroalkyl substances (PFASs) in food and water from Faroe Islands. *Environmental Science and Pollution Research*, 20, 7940-7948.
- ESCHAUZIER, C., BEERENDONK, E., SCHOLTE-VEENENDAAL, P. & DE VOOGT, P. 2012. Impact of treatment processes on the removal of perfluoroalkyl acids from the drinking water production chain. *Environ Sci Technol*, 46, 1708-15.
- ESCHAUZIER, C., HOPPE, M., SCHLUMMER, M. & DE VOOGT, P. 2013a. Presence and sources of anthropogenic perfluoroalkyl acids in high-consumption tap-water based beverages. *Chemosphere*, 90, 36-41.
- ESCHAUZIER, C., RAAT, K. J., STUYFZAND, P. J. & DE VOOGT, P. 2013b. Perfluorinated alkylated acids in groundwater and drinking water: identification, origin and mobility. *Sci Total Environ*, 458-460, 477-85.
- ESSUMANG, D. K., ESHUN, A., HOGARH, J. N., BENTUM, J. K., ADJEI, J. K., NEGISHI, J., NAKAMICHI, S., HABIBULLAH-AL-MAMUN, M. & MASUNAGA, S. 2017. Perfluoroalkyl acids (PFAAs) in the Pra and Kakum River basins and associated tap water in Ghana. *Science of the Total Environment*, 579, 729-735.

ANNEX XV RESTRICTION REPORT – PFAS IN FIREFIGHTING FOAMS

- EUROFEU 2021. Comment #889 on the SEAC draft opinion on the PFHxA restriction, available in ORCOM Part 2 at <https://echa.europa.eu/registry-of-restriction-intentions/-/dislist/details/0b0236e18323a25d>.
- EVO CRA 2017. OCRA use in decontamination of PFOS, PFOA and short chain precursor (SCP) contaminated water.
- FALK, S., BRUNN, H., SCHRÖTER-KERMANI, C., FAILING, K., GEORGII, S., TARRICONE, K. & STAHL, T. 2012. Temporal and spatial trends of perfluoroalkyl substances in liver of roe deer (*Capreolus capreolus*). *Environmental Pollution*, 171, 1-8.
- FALK, S., STAHL, T., FLIEDNER, A., RÜDEL, H., TARRICONE, K., BRUNN, H. & KOSCHORRECK, J. 2019. Levels, accumulation patterns and retrospective trends of perfluoroalkyl acids (PFAAs) in terrestrial ecosystems over the last three decades. *Environmental Pollution*, 246, 921-931.
- FAXNELD, S., BERGER, U., HELANDER, B., DANIELSSON, S., MILLER, A., NYBERG, E., PERSSON, J.-O. & BIGNERT, A. 2016. Temporal Trends and Geographical Differences of Perfluoroalkyl Acids in Baltic Sea Herring and White-Tailed Sea Eagle Eggs in Sweden. *Environmental Science & Technology*, 50, 13070-13079.
- FFFC 2016. Best Practice Guidance for Use of Class B Firefighting Foams.
- FILIPOVIC, M. & BERGER, U. 2015. Are perfluoroalkyl acids in waste water treatment plant effluents the result of primary emissions from the technosphere or of environmental recirculation? *Chemosphere*, 129, 74-80.
- FILIPOVIC, M., WOLDEGIORGIS, A., NORSTROM, K., BIBI, M., LINDBERG, M. & OSTERAS, A. H. 2014. Historical usage of aqueous film forming foam: A case study of the widespread distribution of perfluoroalkyl acids from a military airport to groundwater, lakes, soils and fish. *Chemosphere*.
- FILIPOVIC, M., WOLDEGIORGIS, A., NORSTRÖM, K., BIBI, M., LINDBERG, M. & ÖSTERÅS, A. H. 2015. Historical usage of aqueous film forming foam: A case study of the widespread distribution of perfluoroalkyl acids from a military airport to groundwater, lakes, soils and fish. *Chemosphere*, 129, 39-45.
- FIRE-RESCUE-VICTORIA 2021. PFAS Decontamination Process.
- FPA-AUS 2020. Selection and use of firefighting foams
- FREELING, F., BEHRINGER, D., HEYDEL, F., SCHEURER, M., TERNES, T. A. & NÖDLER, K. 2020. Trifluoroacetate in Precipitation: Deriving a Benchmark Data Set. *Environmental Science & Technology*, 54, 11210-11219.
- FREELING, F. & SCHEURER, M. 2021. Langzeittrends für Trifluoressigsäure in terrestrischen Umweltproben - Untersuchung von Pflanzenproben der Umweltprobenbank des Bundes (UPB) auf Trifluoressigsäure. *Umweltbundesamt*.
- GAGO-FERRERO, P., BLETSOU, A., DAMALAS, D., AALIZADEH, R., ALYGIZAKIS, N., SINGER, H., HOLLENDER, J. & THOMAIDIS, N. 2020. Wide-scope target screening of >2000 emerging contaminants in wastewater samples with UPLC-Q-ToF-HRMS/MS and smart evaluation of its performance through the validation of 195 selected representative analytes. *Journal of Hazardous Materials*, 387.
- GAO, K., MIAO, X., FU, J., CHEN, Y., LI, H., PAN, W., FU, J., ZHANG, Q., ZHANG, A. & JIANG, G. 2020. Occurrence and trophic transfer of per- and polyfluoroalkyl substances in an Antarctic ecosystem. *Environmental Pollution*, 257.

ANNEX XV RESTRICTION REPORT – PFAS IN FIREFIGHTING FOAMS

- GAO, Q., BLUM, K. M., GAGO-FERRERO, P., WIBERG, K., AHRENS, L. & ANDERSSON, P. L. 2019. Impact of on-site wastewater infiltration systems on organic contaminants in groundwater and recipient waters. *Science of the Total Environment*, 651, 1670-1679.
- GARNETT, J., HALSALL, C., THOMAS, M., CRABECK, O., FRANCE, J., JOERSS, H., EBINGHAUS, R., KAISER, J., LEESON, A. & WYNN, P. M. 2021a. Investigating the Uptake and Fate of Poly- And Perfluoroalkylated Substances (PFAS) in Sea Ice Using an Experimental Sea Ice Chamber. *Environmental Science and Technology*, 55, 9601-9608.
- GARNETT, J., HALSALL, C., VADER, A., JOERSS, H., EBINGHAUS, R., LEESON, A. & WYNN, P. M. 2021b. High Concentrations of Perfluoroalkyl Acids in Arctic Seawater Driven by Early Thawing Sea Ice. *Environmental Science and Technology*, 55, 11049-11059.
- GAWOR, A., SHUNTHIRASINGHAM, C., HAYWARD, S. J., LEI, Y. D., GOUIN, T., MMEREKI, B. T., MASAMBA, W., RUEPERT, C., CASTILLO, L. E., SHOEIB, M., LEE, S. C., HARNER, T. & WANIA, F. 2014. Neutral polyfluoroalkyl substances in the global Atmosphere. *Environmental Sciences: Processes and Impacts*, 16, 404-413.
- GEBBINK, W. A., BIGNERT, A. & BERGER, U. 2016a. Perfluoroalkyl Acids (PFAAs) and Selected Precursors in the Baltic Sea Environment: Do Precursors Play a Role in Food Web Accumulation of PFAAs? *Environ Sci Technol*, 50, 6354-62.
- GEBBINK, W. A., BOSSI, R., RIGÉ, F. F., ROSING-ASVID, A., SONNE, C. & DIETZ, R. 2016b. Observation of emerging per- and polyfluoroalkyl substances (PFASs) in Greenland marine mammals. *Chemosphere*, 144, 2384.
- GEBBINK, W. A., VAN ASSELDONK, L. & VAN LEEUWEN, S. P. J. 2017. Presence of Emerging Per- and Polyfluoroalkyl Substances (PFASs) in River and Drinking Water near a Fluorochemical Production Plant in the Netherlands. *Environmental Science and Technology*, 51, 11057-11065.
- GOBELIUS, L., HEDLUND, J., DÜRIG, W., TRÖGER, R., LILJA, K., WIBERG, K. & AHRENS, L. 2018. Per- and Polyfluoroalkyl Substances in Swedish Groundwater and Surface Water: Implications for Environmental Quality Standards and Drinking Water Guidelines. *Environmental Science and Technology*, 52, 4340-4349.
- GÖCKENER, B., FLIEDNER, A., RÜDEL, H., BADRY, A. & KOSCHORRECK, J. 2022. Long-Term Trends of Per- and Polyfluoroalkyl Substances (PFAS) in Suspended Particular Matter from German Rivers Using the Direct Total Oxidizable Precursor (dTOP) Assay. *Environmental Science & Technology*, 56, 208-217.
- GÖCKENER, B., FLIEDNER, A., RÜDEL, H., FETTIG, I. & KOSCHORRECK, J. 2021. Exploring unknown per- and polyfluoroalkyl substances in the German environment – The total oxidizable precursor assay as helpful tool in research and regulation. *Science of The Total Environment*, 782, 146825.
- GOMEZ-RUIZ, B., GÓMEZ-LAVÍN, S., DIBAN, N., BOITEUX, V., COLIN, A., DAUCHY, X. & URTIAGA, A. 2017. Efficient electrochemical degradation of poly- and perfluoroalkyl substances (PFASs) from the effluents of an industrial wastewater treatment plant. *Chemical Engineering Journal*, 322, 196-204.
- HARRAD, S., DRAGE, D. S., SHARKEY, M. & BERRESHEIM, H. 2020. Perfluoroalkyl substances and brominated flame retardants in landfill-related air, soil, and groundwater from Ireland. *Science of the Total Environment*, 705.

ANNEX XV RESTRICTION REPORT – PFAS IN FIREFIGHTING FOAMS

- HARRAD, S., WEMKEN, N., DRAGE, D. S., ABDALLAH, M. A. E. & COGGINS, A. M. 2019. Perfluoroalkyl Substances in Drinking Water, Indoor Air and Dust from Ireland: Implications for Human Exposure. *Environmental Science and Technology*.
- HAUG, L. S., SALIHOVIC, S., JOGSTEN, I. E., THOMSEN, C., VAN BAVEL, B., LINDSTROM, G. & BECHER, G. 2010. Levels in food and beverages and daily intake of perfluorinated compounds in Norway. *Chemosphere*, 80, 1137-43.
- HEO, J. J., LEE, J. W., KIM, S. K. & OH, J. E. 2014. Foodstuff analyses show that seafood and water are major perfluoroalkyl acids (PFAAs) sources to humans in Korea. *Journal of Hazardous Materials*, 279, 402-409.
- HERZKE, D. 2013. Perfluorinated alkylated substances, brominated flame retardants and chlorinated paraffins in the Norwegian Environment - screening 2013. *NILU*.
- HERZKE, D., HUBER, S., BERVOETS, L., D'HOLLANDER, W., HAJŠLOVA, J., PULKRABOVA, J., BRAMBILLA, G., DE FILIPPIS, S. P., KLENOW, S., HEINEMEYER, G. & DE VOOGT, P. 2013. Perfluorinated alkylated substances in vegetables collected in four European countries; occurrence and human exposure estimations. *Environmental Science and Pollution Research*, 20, 7930-7939.
- HOLMES, N. 2020. PFAS Foam Waste Management. *LASTFIRE Foam Summit Webinars*
- HOLMES, N. & QUEENSLAND 2020a. Input ECHA FWC: PFAS in AFFF, SR 4 waste disposal, and cleaning techniques.
- HOLMES, N. & QUEENSLAND 2020b. PFAS Foam Waste Management. *LASTFIRE Webinar*.
- HORST, J., MCDONOUGH, J., ROSS, I. & HOUTZ, E. 2020. Understanding and Managing the Potential By-Products of PFAS Destruction. *Groundwater Monitoring & Remediation*, 40, 17-27.
- HOUDE, M., DE SILVA, A. O., MUIR, D. C. G. & LETCHER, R. J. 2011. Monitoring of Perfluorinated Compounds in Aquatic Biota: An Updated Review. *Environmental Science & Technology*, 45, 7962-7973.
- HOUTZ, E., SUTTON, R., PARK, J.-S. & SEDLAK, M. 2016. Poly- and perfluoroalkyl substances in wastewater: Significance of unknown precursors, manufacturing shifts, and likely AFFF impacts. *Water Research*, 95, 142-149.
- HOUTZ, E., WANG, M. & PARK, J. S. 2018. Identification and Fate of Aqueous Film Forming Foam Derived Per- and Polyfluoroalkyl Substances in a Wastewater Treatment Plant. *Environ Sci Technol*, 52, 13212-13221.
- HUBER, S., AHRENS, L., BÅRDSSEN, B.-J., SIEBERT, U., BUSTNES, J. O., VÍKINGSSON, G. A., EBINGHAUS, R. & HERZKE, D. 2012. Temporal trends and spatial differences of perfluoroalkylated substances in livers of harbor porpoise (*Phocoena phocoena*) populations from Northern Europe, 1991–2008. *Science of The Total Environment*, 419, 216-224.
- HUBER, S., WARNER, N. A., NYGÅRD, T., REMBERGER, M., HARJU, M., UGGERUD, H. T., KAJ, L. & HANSEN, L. 2015. A broad cocktail of environmental pollutants found in eggs of three seabird species from remote colonies in Norway. *Environmental Toxicology and Chemistry*, 34, 1296-1308.
- HUDCOVÁ, H., VYMAZAL, J. & ROZKOŠNÝ, M. 2019. Present restrictions of sewage sludge application in agriculture within the European Union. *Soil and Water Research*, 14, 104-120.

ANNEX XV RESTRICTION REPORT – PFAS IN FIREFIGHTING FOAMS

- HUNTER ANDERSON, R., ADAMSON, D. T. & STROO, H. F. 2019. Partitioning of poly- and perfluoroalkyl substances from soil to groundwater within aqueous film-forming foam source zones. *Journal of Contaminant Hydrology*, 220, 59-65.
- ITRC 2020. Technical/Regulatory Guidance - Per- and Polyfluoroalkyl Substances (PFAS)
- JANDA, J., NÖDLER, K., BRAUCH, H. J., ZWIENER, C. & LANGE, F. T. 2019. Robust trace analysis of polar (C2-C8) perfluorinated carboxylic acids by liquid chromatography-tandem mass spectrometry: method development and application to surface water, groundwater and drinking water. *Environmental Science and Pollution Research*, 26, 7326-7336.
- JASPERS, V. L. B., HERZKE, D., EULAERS, I., GILLESPIE, B. W. & EENS, M. 2013. Perfluoroalkyl substances in soft tissues and tail feathers of Belgian barn owls (*Tyto alba*) using statistical methods for left-censored data to handle non-detects. *Environment International*, 52, 9-16.
- JIAN, J. M., GUO, Y., ZENG, L., LIANG-YING, L., LU, X., WANG, F. & ZENG, E. Y. 2017. Global distribution of perfluorochemicals (PFCs) in potential human exposure source—A review. *Environment International*, 108, 51-62.
- JIN, H., SHAN, G., ZHU, L., SUN, H. & LUO, Y. 2018. Perfluoroalkyl Acids Including Isomers in Tree Barks from a Chinese Fluorochemical Manufacturing Park: Implication for Airborne Transportation. *Environmental Science and Technology*, 52, 2016-2024.
- JOERSS, H., XIE, Z., WAGNER, C. C., VON APPEN, W.-J., SUNDERLAND, E. M. & EBINGHAUS, R. 2020. Transport of Legacy Perfluoroalkyl Substances and the Replacement Compound HFPO-DA through the Atlantic Gateway to the Arctic Ocean—Is the Arctic a Sink or a Source? *Environmental Science & Technology*, 54, 9958-9967.
- JOIFFF 2020. Foam transition: Is it as simple as "Foam out/ Foam in".
- JOUANNEAU, W., BÅRDSSEN, B.-J., HERZKE, D., JOHNSEN, T. V., EULAERS, I. & BUSTNES, J. O. 2020. Spatiotemporal Analysis of Perfluoroalkyl Substances in White-Tailed Eagle (*Haliaeetus albicilla*) Nestlings from Northern Norway—A Ten-Year Study. *Environmental Science & Technology*, 54, 5011-5020.
- KABORÉ, H. A., VO DUY, S., MUNOZ, G., MÉITÉ, L., DESROSIERS, M., LIU, J., SORY, T. K. & SAUVÉ, S. 2018. Worldwide drinking water occurrence and levels of newly-identified perfluoroalkyl and polyfluoroalkyl substances. *Science of the Total Environment*, 616-617, 1089-1100.
- KACPRZAK, M., NECZAJ, E., FIJAŁKOWSKI, K., GROBELAK, A., GROSSER, A., WORWAG, M., RORAT, A., BRATTEBO, H., ALMÅS, Å. & SINGH, B. R. 2017. Sewage sludge disposal strategies for sustainable development. *Environmental Research*, 156, 39-46.
- KALLENBORN, R. 2004. *Perfluorinated alkylated substances (PFAS) in the Nordic environment*, Nordic Council of Ministers.
- KÄRRMAN, A., THANH, W. & KALLENBORN, R. 2019. PFASs in the Nordic environment Screening of Poly- and Perfluoroalkyl Substances (PFASs) and Extractable Organic Fluorine (EOF) in the Nordic Environment. Nordic Council of Ministers 2019.
- KELLY, B. C., IKONOMOU, M. G., BLAIR, J. D., SURRIDGE, B., HOOVER, D., GRACE, R. & GOBAS, F. A. P. C. 2009. Perfluoroalkyl Contaminants in an Arctic Marine Food Web: Trophic Magnification and Wildlife Exposure. *Environmental Science & Technology*, 43, 4037-4043.

ANNEX XV RESTRICTION REPORT – PFAS IN FIREFIGHTING FOAMS

- KEMI 2016. Strategy for reducing the use of highly fluorinated substances, PFASs. Swedish Chemicals Agency.
- KIM, H., EKPE, O. D., LEE, J. H., KIM, D. H. & OH, J. E. 2019. Field-scale evaluation of the uptake of Perfluoroalkyl substances from soil by rice in paddy fields in South Korea. *Science of the Total Environment*, 671, 714-721.
- KLEIN, A. 1997. *Halogenierte Essigsäuren in der Umwelt*. Dissertation, Universität Bayreuth.
- KLOSTERHAUS, S., YEE, D., SEDLAK, M., WONG, A. & SUTTON, R. 2013. Contaminants of Emerging Concern in San Francisco Bay: A Summary of Occurrence Data and Identification of Data Gaps. RMP Contribution 698. San Francisco Estuary Institute, Richmond, CA. 121 pp.
- KOTAMARTHI, V. R., RODRIGUEZ, J. M., KO, M. K. W., TROMP, T. K., SZE, N. D. & PRATHER, M. J. 1998. Trifluoroacetic acid from degradation of HCFCs and HFCs: A three-dimensional modeling study. *Journal of Geophysical Research: Atmospheres*, 103, 5747-5758.
- KUNACHEVA, C., FUJII, S., TANAKA, S., SENEVIRATNE, S. T., LIEN, N. P., NOZOE, M., KIMURA, K., SHIVAKOTI, B. R. & HARADA, H. 2012. Worldwide surveys of perfluorooctane sulfonate (PFOS) and perfluorooctanoic acid (PFOA) in water environment in recent years. *Water Sci Technol*, 66, 2764-71.
- KWOK, K. Y., YAMAZAKI, E., YAMASHITA, N., TANIYASU, S., MURPHY, M. B., HORII, Y., PETRICK, G., KALLERBORN, R., KANNAN, K., MURANO, K. & LAM, P. K. S. 2013. Transport of Perfluoroalkyl substances (PFAS) from an arctic glacier to downstream locations: Implications for sources. *Science of the Total Environment*, 447, 46-55.
- LAND, M., DE WIT, C. A., BIGNERT, A., COUSINS, I. T., HERZKE, D., JOHANSSON, J. H. & MARTIN, J. W. 2018. What is the effect of phasing out long-chain per- and polyfluoroalkyl substances on the concentrations of perfluoroalkyl acids and their precursors in the environment? A systematic review. *Environmental Evidence*, 7, 4.
- LANGBERG, H. A., ARP, H. P. H., BREEDVELD, G. D., SLINDE, G. A., HØISETER, Å., GRØNNING, H. M., JARTUN, M., RUNDBERGET, T., JENSSEN, B. M. & HALE, S. E. 2021. Paper product production identified as the main source of per- and polyfluoroalkyl substances (PFAS) in a Norwegian lake: Source and historic emission tracking. *Environmental Pollution*, 273, 116259.
- LANUV-VOLAND-RESPONSE 2021. ECHA FWC: PFAS in AFFF, SR 4 waste disposal, and cleaning techniques. . In: SCHÖPEL, M. (ed.).
- LANUV 2009. Perfluorierte Tenside in Feuerlöschmitteln. In: MINISTERIUM FÜR UMWELT UND NATURSCHUTZ, L. U. V. N. R. W. (ed.).
- LASTFIRE-INTERVIEW 2021. Interview with Niall Ramsden and Mark Plastow concerning ECHA FWC: PFAS in AFFF, SR 4 waste disposal, and cleaning techniques. . In: SCHÖPEL, M. (ed.).
- LEC-BRANDWEERBRZO-SUBMISSION 2021. EC. In: SEVESO), L. E. L. B. D. N. E. C. F. F. B. (ed.).
- LEE, H., TEVLIN, A. G., MABURY, S. A. & MABURY, S. A. 2014. Fate of polyfluoroalkyl phosphate diesters and their metabolites in biosolids-applied soil: biodegradation and plant uptake in greenhouse and field experiments. *Environ Sci Technol*, 48, 340-9.

ANNEX XV RESTRICTION REPORT – PFAS IN FIREFIGHTING FOAMS

- LENKA, S. P., KAH, M. & PADHYE, L. P. 2021. A review of the occurrence, transformation, and removal of poly- and perfluoroalkyl substances (PFAS) in wastewater treatment plants. *Water Research*, 199, 117187.
- LESCORD, G. L., KIDD, K. A., DE SILVA, A. O., WILLIAMSON, M., SPENCER, C., WANG, X. & MUIR, D. C. G. 2015. Perfluorinated and Polyfluorinated Compounds in Lake Food Webs from the Canadian High Arctic. *Environmental Science & Technology*, 49, 2694-2702.
- LETCHER, R. J., BUSTNES, J. O., DIETZ, R., JENSSEN, B. M., JØRGENSEN, E. H., SONNE, C., VERREAULT, J., VIJAYAN, M. M. & GABRIELSEN, G. W. 2010. Exposure and effects assessment of persistent organohalogen contaminants in arctic wildlife and fish. *Science of the Total Environment*, 408, 2995-3043.
- LETCHER, R. J., CHU, S., MCKINNEY, M. A., TOMY, G. T., SONNE, C. & DIETZ, R. 2014. Comparative hepatic in vitro depletion and metabolite formation of major perfluorooctane sulfonate precursors in arctic polar bear, beluga whale, and ringed seal. *Chemosphere*, 112, 225-231.
- LETCHER, R. J., MORRIS, A. D., DYCK, M., SVERKO, E., REINER, E. J., BLAIR, D. A. D., CHU, S. G. & SHEN, L. 2018. Legacy and new halogenated persistent organic pollutants in polar bears from a contamination hotspot in the Arctic, Hudson Bay Canada. *Science of the Total Environment*, 610-611, 121-136.
- LFU-GIERIG-INTERVIEW 2021. Interview with Dr. Michael Gierig concerning ECHA FWC: PFAS in AFFF, SR 4 waste disposal and cleaning techniques. .
- LFV-BAYERN 2019. Bavarian Ministry of the Interior, Sport and Integration, and Bavarian Ministry of the Environment and Consumer Protection: Environmentally friendly use of fire-fighting foams (Umweltschonender Einsatz von Feuerlöschschäumen) [in German]; accesible at shorturl.at/osyG1 or via <https://www.bestellen.bayern.de>.
- LI, B. B., HU, L. X., YANG, Y. Y., WANG, T. T., LIU, C. & YING, G. G. 2020. Contamination profiles and health risks of PFASs in groundwater of the Maozhou River basin. *Environmental Pollution*, 260.
- LI, J., SUN, J. & LI, P. 2022. Exposure routes, bioaccumulation and toxic effects of per- and polyfluoroalkyl substances (PFASs) on plants: A critical review. *Environment International*, 158, 106891.
- LI, P., OYANG, X., ZHAO, Y., TU, T., TIAN, X., LI, L., ZHAO, Y., LI, J. & XIAO, Z. 2019. Occurrence of perfluorinated compounds in agricultural environment, vegetables, and fruits in regions influenced by a fluorine-chemical industrial park in China. *Chemosphere*, 225, 659-667.
- LI, P., XIAO, Z., XIE, X., LI, Z., YANG, H., MA, X., SUN, J. & LI, J. 2021. Perfluorooctanoic acid (PFOA) changes nutritional compositions in lettuce (*Lactuca sativa*) leaves by activating oxidative stress. *Environmental Pollution*, 285.
- LIN, Y., RUAN, T. & JIANG, G. 2017. Progress on analytical methods and environmental behavior of emerging per- and polyfluoroalkyl substances. *Kexue Tongbao/Chinese Science Bulletin*, 62, 2724-2733.
- LINDSTROM, A. B., STRYNAR, M. J., DELINSKY, A. D., NAKAYAMA, S. F., MCMILLAN, L., LIBELO, E. L., NEILL, M. & THOMAS, L. 2011. Application of WWTP biosolids and resulting perfluorinated compound contamination of surface and well water in Decatur, Alabama, USA. *Environmental Science and Technology*, 45, 8015-8021.

ANNEX XV RESTRICTION REPORT – PFAS IN FIREFIGHTING FOAMS

- LIU, W., HE, W., WU, J., QIN, N., HE, Q. & XU, F. 2018a. Residues, bioaccumulations and biomagnification of perfluoroalkyl acids (PFAAs) in aquatic animals from Lake Chaohu, China. *Environmental Pollution*, 240, 607-614.
- LIU, Y., QIAN, M., MA, X., ZHU, L. & MARTIN, J. W. 2018b. Nontarget Mass Spectrometry Reveals New Perfluoroalkyl Substances in Fish from the Yangtze River and Tangxun Lake, China. *Environmental Science & Technology*, 52, 5830-5840.
- LIU, Y. E. A. 2018. Y. Liu, E.S. Richardson, A.E. Derocher, N.J. Lunn, H.-J. Lehmler, X. Li, Y. Zhang, J.Y. Cui, L. Cheng, J.W. Martin
Hundreds of unrecognized halogenated contaminants discovered in polar bear serum
Angew. Chem. Int. Ed., 57 (2018), pp. 16401-16406.
- LIU, Z., LU, Y., SHI, Y., WANG, P., JONES, K., SWEETMAN, A. J., JOHNSON, A. C., ZHANG, M., ZHOU, Y., LU, X., SU, C., SARVAJAYAKESAVALUC, S. & KHAN, K. 2017a. Crop bioaccumulation and human exposure of perfluoroalkyl acids through multi-media transport from a mega fluorochemical industrial park, China. *Environment International*, 106, 37-47.
- LIU, Z., LU, Y., SONG, X., JONES, K., SWEETMAN, A. J., JOHNSON, A. C., ZHANG, M., LU, X. & SU, C. 2019. Multiple crop bioaccumulation and human exposure of perfluoroalkyl substances around a mega fluorochemical industrial park, China: Implication for planting optimization and food safety. *Environment International*, 127, 671-684.
- LIU, Z., LU, Y., WANG, P., WANG, T., LIU, S., JOHNSON, A. C., SWEETMAN, A. J. & BANINLA, Y. 2017b. Pollution pathways and release estimation of perfluorooctane sulfonate (PFOS) and perfluorooctanoic acid (PFOA) in central and eastern China. *Science of the Total Environment*, 580, 1247-1256.
- LIU, Z., LU, Y., WANG, T., WANG, P., LI, Q., JOHNSON, A. C., SARVAJAYAKESAVALU, S. & SWEETMAN, A. J. 2016. Risk assessment and source identification of perfluoroalkyl acids in surface and ground water: Spatial distribution around a mega-fluorochemical industrial park, China. *Environment International*, 91, 69-77.
- LLORCA, M., FARRE, M., PICO, Y., MULLER, J., KNEPPER, T. P. & BARCELO, D. 2012a. Analysis of perfluoroalkyl substances in waters from Germany and Spain. *Sci Total Environ*, 431, 139-50.
- LLORCA, M., FARRÉ, M., TAVANO, M. S., ALONSO, B., KOREMBLIT, G. & BARCELÓ, D. 2012b. Fate of a broad spectrum of perfluorinated compounds in soils and biota from Tierra del Fuego and Antarctica. *Environmental Pollution*, 163, 158-166.
- LORENZO, M., CAMPO, J., SUÁREZ-VARELA, M. M. & PICÓ, Y. 2019. Occurrence, distribution and behavior of emerging persistent organic pollutants (POPs) in a Mediterranean wetland protected area. 646, 1009-1020.
- LUNDIN, L. & JANSSON, S. A desktop study on destruction of persistent organic compounds in combustion systems. 2017.
- MACINNIS, J. J., LEHNHERR, I., MUIR, D. C. G., ST PIERRE, K. A., ST LOUIS, V. L., SPENCER, C. & DE SILVA, A. O. 2019. Fate and transport of perfluoroalkyl substances from snowpacks into a lake in the high Arctic of Canada. *Environ. Sci. Technol.*, 53, 10753.

ANNEX XV RESTRICTION REPORT – PFAS IN FIREFIGHTING FOAMS

- MAGA, D., ARYAN, V. & BRUZZANO, S. 2021. Environmental Assessment of Various End-of-Life Pathways for Treating Per- and Polyfluoroalkyl Substances in Spent Fire-Extinguishing Waters. *Environ Toxicol Chem*, 40, 947-957.
- MAZZONI, M., RUSCONI, M., VALSECCHI, S., MARTINS, C. P. & POLESELLO, S. 2015. An on-line solid phase extraction-liquid chromatography-tandem mass spectrometry method for the determination of perfluoroalkyl acids in drinking and surface waters. *J Anal Methods Chem*, 2015, 942016.
- MCCLEAF, P., ENGLUND, S., ÖSTLUND, A., LINDEGREN, K., WIBERG, K. & AHRENS, L. 2017. Removal efficiency of multiple poly- and perfluoroalkyl substances (PFASs) in drinking water using granular activated carbon (GAC) and anion exchange (AE) column tests. *Water Res*, 120, 77-87.
- MEYER, J., JASPERS, V. L. B., EENS, M. & DE COEN, W. 2009. The relationship between perfluorinated chemical levels in the feathers and livers of birds from different trophic levels. *Science of The Total Environment*, 407, 5894-5900.
- MOURIER, B., LABADIE, P., DESMET, M., GROBOIS, C., RAUX, J., DEBRET, M., COPARD, Y., PARDON, P., BUDZINSKI, H. & BABUT, M. 2019. Combined spatial and retrospective analysis of fluoroalkyl chemicals in fluvial sediments reveal changes in levels and patterns over the last 40 years. *Environmental Pollution*, 253, 1117-1125.
- MUIR, D. 2015a. Community based seawater monitoring for organic contaminants and mercury in the Canadian Arctic
- Synopsis of Research Conducted under the 2014-2015, Northern Contaminants Program, Aboriginal Affairs and Northern Development Canada, Ottawa., Aboriginal Affairs and Northern Development Canada, Ottawa, ON (2015), pp. 289-296.
- MUIR, D., BOSSI, R., CARLSSON, P., EVANS, M., DE SILVA, A., HALSALL, C., RAUERT, C., HERZKE, D., HUNG, H., LETCHER, R., RIGÉT, F. & ROOS, A. 2019. Levels and trends of poly- and perfluoroalkyl substances in the Arctic environment – An update. *Emerging Contaminants*, 5, 240-271.
- MUIR, D. & MIAZ, L. T. 2021. Spatial and Temporal Trends of Perfluoroalkyl Substances in Global Ocean and Coastal Waters. *Environmental Science & Technology*, 55, 9527-9537.
- MUIR, D. W., X; HOUDE, M. 2015b. Temporal trends of persistent organic pollutants and metals in ringed seals from the Canadian Arctic
- Synopsis of Research Conducted under the 2014-2015, Northern Contaminants Program, Aboriginal Affairs and Northern Development Canada, Ottawa, ON (2015), pp. 189-198.
- MÜLLER, C. E., DE SILVA, A. O., SMALL, J., WILLIAMSON, M., WANG, X., MORRIS, A., KATZ, S., GAMBERG, M. & MUIR, D. C. G. 2011a. Biomagnification of perfluorinated compounds in a remote terrestrial food chain: Lichen-Caribou-Wolf. *Environmental Science and Technology*, 45, 8665-8673.
- MÜLLER, C. E., DE SILVA, A. O., SMALL, J., WILLIAMSON, M., WANG, X., MORRIS, A., KATZ, S., GAMBERG, M. & MUIR, D. C. G. 2011b. Biomagnification of Perfluorinated Compounds in a Remote Terrestrial Food Chain: Lichen-Caribou-Wolf. *Environmental Science & Technology*, 45, 8665-8673.
- MÜLLER, C. E., GERECKE, A. C., BOGDAL, C., WANG, Z., SCHERINGER, M. & HUNGERBÜHLER, K. 2012. Atmospheric fate of poly- and perfluorinated alkyl

ANNEX XV RESTRICTION REPORT – PFAS IN FIREFIGHTING FOAMS

- substances (PFASs): I. Day-night patterns of air concentrations in summer in Zurich, Switzerland. *Environmental Pollution*, 169, 196-203.
- MUNOZ, G., BUDZINSKI, H., BABUT, M., LOBRY, J., SELLESLAGH, J., TAPIE, N. & LABADIE, P. 2019. Temporal variations of perfluoroalkyl substances partitioning between surface water, suspended sediment, and biota in a macrotidal estuary. *Chemosphere*, 233, 319-326.
- MUNOZ, G., BUDZINSKI, H. & LABADIE, P. 2017a. Influence of Environmental Factors on the Fate of Legacy and Emerging Per- and Polyfluoroalkyl Substances along the Salinity/Turbidity Gradient of a Macrotidal Estuary. *Environmental Science & Technology*, 51, 12347-12357.
- MUNOZ, G., LABADIE, P., BOTTA, F., LESTREMAU, F., LOPEZ, B., GENESTE, E., PARDON, P., DEVIER, M. H. & BUDZINSKI, H. 2017b. Occurrence survey and spatial distribution of perfluoroalkyl and polyfluoroalkyl surfactants in groundwater, surface water, and sediments from tropical environments. *Sci Total Environ*, 607-608, 243-252.
- NAVARRO, I., DE LA TORRE, A., SANZ, P., PRO, J., CARBONELL, G. & DE LOS ÁNGELES MARTÍNEZ, M. 2016. Bioaccumulation of emerging organic compounds (perfluoroalkyl substances and halogenated flame retardants) by earthworm in biosolid amended soils. *Environmental research*, 149, 32-39.
- NEWTON, S., MCMAHEN, R., STOECKEL, J. A., CHISLOCK, M., LINDSTROM, A. & STRYNAR, M. 2017. Novel Polyfluorinated Compounds Identified Using High Resolution Mass Spectrometry Downstream of Manufacturing Facilities near Decatur, Alabama. *Environ Sci Technol*.
- NILU 2015. Monitoring of environmental contaminants in air and precipitation, annual report 2014. M-368. *NILU*, 90.
- NILU 2021. F-gases in the remote region of Svalbard for the time period 2001-2020. *Norwegian Institute for Air Research*.
- NORDIC COUNCIL 2019. The cost of inaction: A socioeconomic analysis of environmental and health impacts linked to exposure to PFAS.
- NORMAN DATABASE. 2021. <https://www.norman-network.com/nds/> [Online]. [Accessed].
- NORWEGIAN INSTITUTE FOR WATER RESEARCH (NIVA) 2017. Environmental Contaminants in an Urban Fjord - 2016,.
- OPEC-SYSTEMS 2020. Validation of Foam Fractionation as an Effective Treatment Technology.
- ORSI, A. H., WHITWORTH III, T. & NOWLIN JR, W. D. 1995. On the meridional extent and fronts of the Antarctic Circumpolar Current. *Deep-Sea Research Part I*, 42, 641-673.
- PATTERSON, C. & DASTGHEIB, S. 2020. Cement Kiln and Waste to Energy Incineration of Spent Media. To be Presented at THERMAL TREATMENT OF PFAS STATE OF THE SCIENCE WORKSHOP,.
- PEREIRA, M. G., LACORTE, S., WALKER, L. A. & SHORE, R. F. 2021. Contrasting long term temporal trends in perfluoroalkyl substances (PFAS) in eggs of the northern gannet (*Morus bassanus*) from two UK colonies. *Science of The Total Environment*, 754, 141900.

ANNEX XV RESTRICTION REPORT – PFAS IN FIREFIGHTING FOAMS

- PERKOLA, N. & SAINIO, P. 2013. Survey of perfluorinated alkyl acids in Finnish effluents, storm water, landfill leachate and sludge. *Environmental Science and Pollution Research*, 20, 7979–7987.
- PICKARD, H. M., CRISCITIELLO, A. S., PERSAUD, D., SPENCER, C., MUIR, D. C. G., LEHNHERR, I., SHARP, M. J., DE SILVA, A. O. & YOUNG, C. J. 2020. Ice Core Record of Persistent Short-Chain Fluorinated Alkyl Acids: Evidence of the Impact From Global Environmental Regulations. *Geophysical Research Letters*, 47.
- PICKARD, H. M., CRISCITIELLO, A. S., SPENCER, C., SHARP, M. J., MUIR, D. C. G., DE SILVA, A. O. & YOUNG, C. J. 2018. Continuous non-marine inputs of per- and polyfluoroalkyl substances to the High Arctic: a multi-decadal temporal record. *Atmos. Chem. Phys.*, 18, 5045-5058.
- PIGNOTTI, E., CASAS, G., LLORCA, M., TELLBÜSCHER, A., ALMEIDA, D., DINELLI, E., FARRÉ, M. & BARCELÓ, D. 2017. Seasonal variations in the occurrence of perfluoroalkyl substances in water, sediment and fish samples from Ebro Delta (Catalonia, Spain). *Science of the Total Environment*, 607-608, 933-943.
- RAMBOLL 2021. ECHA FWC: PFAS in firefighting foams, SR 4 PFAS waste disposal methods and equipment cleaning methods, unpublished.
- RANKIN, K., MABURY, S. A., JENKINS, T. M. & WASHINGTON, J. W. 2016. A North American and global survey of perfluoroalkyl substances in surface soils: Distribution patterns and mode of occurrence. *Chemosphere*, 161, 333-341.
- RAUERT, C., SHOIEB, M., SCHUSTER, J. K., ENG, A. & HARNER, T. 2018. Atmospheric concentrations and trends of poly- and perfluoroalkyl substances (PFAS) and volatile methyl siloxanes (VMS) over 7 years of sampling in the Global Atmospheric Passive Sampling (GAPS) network. *Environmental Pollution*, 238, 94-102.
- RIGÉT, F., BOSSI, R., SONNE, C., VORKAMP, K. & DIETZ, R. 2013. Trends of perfluorochemicals in Greenland ringed seals and polar bears: Indications of shifts to decreasing trends. *Chemosphere*, 93, 1607-1614.
- ROESCH, P., VOGEL, C. & SIMON, F. G. 2020. Reductive Defluorination and Mechanochemical Decomposition of Per- and Polyfluoroalkyl Substances (PFASs): From Present Knowledge to Future Remediation Concepts. *Int J Environ Res Public Health*, 17.
- ROOS, A., BERGER, U., JÄRNBERG, U., VAN DIJK, J. & BIGNERT, A. 2013. Increasing Concentrations of Perfluoroalkyl Acids in Scandinavian Otters (*Lutra lutra*) between 1972 and 2011: A New Threat to the Otter Population? *Environmental Science & Technology*, 47, 11757-11765.
- ROOS, A. M., GAMBERG, M., MUIR, D., KÄRRMAN, A., CARLSSON, P., CUYLER, C., LIND, Y., BOSSI, R. & RIGÉT, F. 2021. Perfluoroalkyl substances in circum-Arctic Rangifer: caribou and reindeer. *Environmental Science and Pollution Research*.
- ROSS, I., MCDONOUGH, J., MILES, J., STORCH, P., THELAKKAT KOCHUNARAYANAN, P., KALVE, E., HURST, J., S. DASGUPTA, S. & BURDICK, J. 2018. A review of emerging technologies for remediation of PFASs. *Remediation Journal*, 28, 101-126.
- ROTANDER, A., KÄRRMAN, A., BAVEL, B. V., POLDER, A., RIGÉT, F., AUDUNSSON, G. A., VÍKINGSSON, G., GABRIELSEN, G. W., BLOCH, D. & DAM, M. 2012. Increasing levels of long-chain perfluorocarboxylic acids (PFCAs) in Arctic and North Atlantic marine mammals, 1984-2009. *Chemosphere*, 86, 278-285.

ANNEX XV RESTRICTION REPORT – PFAS IN FIREFIGHTING FOAMS

- ROUTTI, H., AARS, J., FUGLEI, E., HANSSSEN, L., LONE, K., POLDER, A., PEDERSEN, Å. Ø., TARTU, S., WELKER, J. M. & YOCCOZ, N. G. 2017. Emission Changes Dwarf the Influence of Feeding Habits on Temporal Trends of Per- and Polyfluoroalkyl Substances in Two Arctic Top Predators. *Environmental Science & Technology*, 51, 11996-12006.
- ROUTTI, H., GABRIELSEN, G. W., HERZKE, D., KOVACS, K. M. & LYDERSEN, C. 2016. Spatial and temporal trends in perfluoroalkyl substances (PFASs) in ringed seals (*Pusa hispida*) from Svalbard. *Environmental Pollution*, 214, 230-238.
- ROUTTI, H., KRAFFT, B. A., HERZKE, D., EISERT, R. & OFTEDAL, O. 2015. Perfluoroalkyl substances detected in the world's southernmost marine mammal, the Weddell seal (*Leptonychotes weddellii*). *Environ Pollut*, 197, 62-67.
- SAMMUT, G., SINAGRA, E., SAPIANO, M., HELMUS, R. & DE VOOGT, P. 2019. Perfluoroalkyl substances in the Maltese environment – (II) sediments, soils and groundwater. *Science of the Total Environment*, 682, 180-189.
- SANDBLOM, O. 2014. *Waste Incineration as a Possible Source of Perfluoroalkyl Acids to the Environment – Method Development and Screening*. Master, Stockholm University.
- SCHER, D. P., KELLY, J. E., HUSET, C. A., BARRY, K. M., HOFFBECK, R. W., YINGLING, V. L. & MESSING, R. B. 2018. Occurrence of perfluoroalkyl substances (PFAS) in garden produce at homes with a history of PFAS-contaminated drinking water. *Chemosphere*, 196, 548-555.
- SCHERINGER, M. 2009. Long-range transport of organic chemicals in the environment. *Environ. Toxicol. Chem.*, 28, 677.
- SCHIAVONE, A., CORSOLINI, S., KANNAN, K., TAO, L., TRIVELPIECE, W., TORRES JR, D. & FOCARDI, S. 2009. Perfluorinated contaminants in fur seal pups and penguin eggs from South Shetland, Antarctica. *Science of the Total Environment*, 407, 3899-3904.
- SCHLABACH, M., VAN BAVEL, B., BAZ LOMBA, J. A., BORGEN, A., GABRIELSEN, G. W., GÖTSCH, A., HALSE, A. K., HANSSSEN, L., SUNDE KROGSETH, I., NIKIFOROV, V., NYGÅRD, T., BOHLIN NIZZETTO, P., REID, M., ROSTKOWSKI, P., SAMANIPOUR, S. & SCREENING, P. 2018. AMAP Assessment Compounds. M-1080. 93.
- SCHULTES, L., SANDBLOM, O., BROEG, K., BIGNERT, A. & BENSKIN, J. P. 2020a. Temporal Trends (1981–2013) of Per- and Polyfluoroalkyl Substances and Total Fluorine in Baltic cod (*Gadus morhua*). *Environmental Toxicology and Chemistry*, 39, 300-309.
- SCHULTES, L., VAN NOORDENBURG, C., SPAAN, K. M., PLASSMANN, M. M., SIMON, M., ROOS, A. & BENSKIN, J. P. 2020b. High Concentrations of Unidentified Extractable Organofluorine Observed in Blubber from a Greenland Killer Whale (*Orcinus orca*). *Environmental Science & Technology Letters*, 7, 909-915.
- SCHULTZ, M. M., HIGGINS, C. P., HUSET, C. A., LUTHY, R. G., BAROFSKY, D. F. & FIELD, J. A. 2006. Fluorochemical mass flows in a municipal wastewater treatment facility. *Environ Sci Technol*, 40, 7350-7357.
- SCHWANZ, T. G., LLORCA, M., FARRE, M. & BARCELO, D. 2016. Perfluoroalkyl substances assessment in drinking waters from Brazil, France and Spain. *Sci Total Environ*, 539, 143-152.
- SCOTT, B. F., SPENCER, C., MABURY, S. A. & MUIR, D. C. G. 2006. Poly and perfluorinated carboxylates in north American precipitation. *Environmental Science and Technology*, 40, 7167-7174.

ANNEX XV RESTRICTION REPORT – PFAS IN FIREFIGHTING FOAMS

- SEMERÁD, J., HATASOVÁ, N., GRASSEROVÁ, A., ČERNÁ, T., FILIPOVÁ, A., HANČ, A., INNEMANOVÁ, P., PIVOKONSKÝ, M. & CAJTHAML, T. 2020. Screening for 32 per- and polyfluoroalkyl substances (PFAS) including GenX in sludges from 43 WWTPs located in the Czech Republic - Evaluation of potential accumulation in vegetables after application of biosolids. *Chemosphere*, 261, 128018.
- SEPULVADO, J. G., BLAINE, A. C., HUNDAL, L. S. & HIGGINS, C. P. 2011. Occurrence and fate of perfluorochemicals in soil following the land application of municipal biosolids. *Environ Sci Technol*, 45, 8106-12.
- SHAN, G., WEI, M., ZHU, L., LIU, Z. & ZHANG, Y. 2014. Concentration profiles and spatial distribution of perfluoroalkyl substances in an industrial center with condensed fluorochemical facilities. *Science of the Total Environment*, 490, 351-359.
- SHIWAKU, Y., LEE, P., THEPAKSORN, P., ZHENG, B., KOIZUMI, A. & HARADA, K. H. 2016. Spatial and temporal trends in perfluorooctanoic and perfluorohexanoic acid in well, surface, and tap water around a fluoropolymer plant in Osaka, Japan. *Chemosphere*, 164, 603-610.
- SHOEIB, M., HARNER, T. & VLAHOS, P. 2006. Perfluorinated chemicals in the arctic atmosphere. *Environmental Science and Technology*, 40, 7577-7583.
- SIMS, J. L., STROSKI, K. M., KIM, S., KILLEEN, G., EHALT, R., SIMCIK, M. F. & BROOKS, B. W. 2021. Global occurrence and probabilistic environmental health hazard assessment of per- and polyfluoroalkyl substances (PFASs) in groundwater and surface waters. *Science of The Total Environment*, 151535.
- SKOV, H., MASSLING, A., NIELSEN, I. E., NORDSTRØM, C., BOSSI, R., VORKAMP, K., CHRISTENSEN, J., LARSEN, M. M., HANSEN, K. M., LIISBERG, J. & POULSEN, M. B. 2017. AMAP CORE - atmospheric part. Results from Villum Research Station. Technical report from DCE - Danish centre for environment and energy No. 101. Aarhus University, DCE - Danish Centre for Environment and Energy, 77.
- SPAAN, K. M., VAN NOORDENBURG, C., PLASSMANN, M. M., SCHULTES, L., SHAW, S., BERGER, M., HEIDE-JØRGENSEN, M. P., ROSING-ASVID, A., GRANQUIST, S. M., DIETZ, R., SONNE, C., RIGÉT, F., ROOS, A. & BENSKIN, J. P. 2020. Fluorine Mass Balance and Suspect Screening in Marine Mammals from the Northern Hemisphere. *Environmental Science & Technology*, 54, 4046-4058.
- STASINAKIS, A. S., THOMAIDIS, N. S., ARVANITI, O. S., ASIMAKOPOULOS, A. G., SAMARAS, V. G., AJIBOLA, A., MAMAIS, D. & LEKKAS, T. D. 2013. Contribution of primary and secondary treatment on the removal of benzothiazoles, benzotriazoles, endocrine disruptors, pharmaceuticals and perfluorinated compounds in a sewage treatment plant. *Science of The Total Environment*, 463-464, 1067-1075.
- STOCK, N. L., FURDUI, V. I., MUIR, D. C. G. & MABURY, S. A. 2007. Perfluoroalkyl contaminants in the Canadian arctic: Evidence of atmospheric transport and local contamination. *Environmental Science and Technology*, 41, 3529-3536.
- STOIBER, T., EVANS, S. & NAIDENKO, O. V. 2020. Disposal of products and materials containing per-and polyfluoroalkyl substances (PFAS): A cyclical problem. *Chemosphere*, 260, 127659.
- STRYNAR, M., DAGNINO, S., MCMAHEN, R., LIANG, S., LINDSTROM, A., ANDERSEN, E., MCMILLAN, L., THURMAN, M., FERRER, I. & BALL, C. 2015. Identification of Novel Perfluoroalkyl Ether Carboxylic Acids (PFECAs) and Sulfonic Acids (PFESAs) in Natural Waters Using Accurate Mass Time-of-Flight Mass Spectrometry (TOFMS). *Environ Sci Technol*, 49, 11622-30.

ANNEX XV RESTRICTION REPORT – PFAS IN FIREFIGHTING FOAMS

- STRYNAR, M. J., LINDSTROM, A. B., NAKAYAMA, S. F., EGEHY, P. P. & HELFANT, L. J. 2012. Pilot scale application of a method for the analysis of perfluorinated compounds in surface soils. *Chemosphere*, 86, 252-7.
- SUN, J., BOSSI, R., BUSTNES, J. O., HELANDER, B., BOERTMANN, D., DIETZ, R., HERZKE, D., JASPERS, V. L. B., LABANSEN, A. L., LEPOINT, G., SCHULZ, R., SONNE, C., THORUP, K., TØTTRUP, A. P., ZUBROD, J. P., EENS, M. & EULAERS, I. 2019a. White-Tailed Eagle (*Haliaeetus albicilla*) Body Feathers Document Spatiotemporal Trends of Perfluoroalkyl Substances in the Northern Environment. *Environmental Science and Technology*, 53, 12744-12753.
- SUN, J., BOSSI, R., BUSTNES, J. O., HELANDER, B., BOERTMANN, D., DIETZ, R., HERZKE, D., JASPERS, V. L. B., LABANSEN, A. L., LEPOINT, G., SCHULZ, R., SONNE, C., THORUP, K., TØTTRUP, A. P., ZUBROD, J. P., EENS, M. & EULAERS, I. 2019b. White-Tailed Eagle (*Haliaeetus albicilla*) Body Feathers Document Spatiotemporal Trends of Perfluoroalkyl Substances in the Northern Environment. *Environmental Science & Technology*, 53, 12744-12753.
- SZNAJDER, K., SKA, K., SURMA, M., CIE, LIK, E. & WICZKOWSKI, W. 2018. The perfluoroalkyl substances (PFASs) contamination of fruits and vegetables. *Food Additives and Contaminants - Part A Chemistry, Analysis, Control, Exposure and Risk Assessment*, 35, 1776-1786.
- TANIYASU, S., YAMASHITA, N., MOON, H. B., KWOK, K. Y., LAM, P. K. S., HORII, Y., PETRICK, G. & KANNAN, K. 2013. Does wet precipitation represent local and regional atmospheric transportation by perfluorinated alkyl substances? *Environment International*, 55, 25-32.
- TAO, L., KANNAN, K., KAJIWARA, N., COSTA, M. M., FILLMANN, G., TAKAHASHI, S. & TANABE, S. 2006. Perfluorooctanesulfonate and related fluorochemicals in albatrosses, elephant seals, penguins, and polar skuas from the southern ocean. *Environmental Science and Technology*, 40, 7642-7648.
- TARTU, S., GABRIELSEN, G. W., BLÉVIN, P., ELLIS, H., BUSTNES, J. O., HERZKE, D. & CHASTEL, O. 2014. Endocrine and fitness correlates of long-chain perfluorinated carboxylates exposure in arctic breeding black-legged kittiwakes. *Environmental Science and Technology*, 48, 13504-13510.
- THOMPSON, J., EAGLESHAM, G. & MUELLER, J. 2011. Concentrations of PFOS, PFOA and other perfluorinated alkyl acids in Australian drinking water. *Chemosphere*, 83, 1320-5.
- TRIMMEL, S., VIKE-JONAS, K., GONZALEZ, S. V., CIESIELSKI, T. M., LINDSTRØM, U., JENSSEN, B. M. & ASIMAKOPOULOS, A. G. 2021. Rapid Determination of Per- and Polyfluoroalkyl Substances (PFAS) in Harbour Porpoise Liver Tissue by HybridSPE®-UPLC®-MS/MS. *Toxics*, 9, 183.
- UBA 2020. Remediation management for local and wide-spread PFAS contaminations.
- ULRICH, H., FREIER, K. P. & GIERIG, M. 2016. Getting on with persistent pollutants: Decreasing trends of perfluoroalkyl acids (PFAAs) in sewage sludge. *Chemosphere*, 161, 527-35.
- UNEP 2012. Guidance on best available techniques and best environmental practices for the use of perfluorooctane sulfonic acid (PFOS) and related chemicals listed under the Stockholm Convention on Persistent Organic Pollutants, draft 2012, retrieved from <http://www.pops.int/Portals/0/download.aspx?d=UNEP-POPS-NIP-GUID-2012-BATBEPFOS.En.pdf>.

ANNEX XV RESTRICTION REPORT – PFAS IN FIREFIGHTING FOAMS

- US-EPA 2020a. Interim Guidance on the Destruction and Disposal of Perfluoroalkyl and Polyfluoroalkyl Substances and Materials Containing Perfluoroalkyl and Polyfluoroalkyl Substances.
- US-EPA 2020b. Per- and Polyfluoroalkyl Substances (PFAS): Incineration to Manage PFAS Waste Streams.
- VEILLETTE, J., MUIR, D. C. G., ANTONIADES, D., SMALL, J. M., SPENCER, C., LOEWEN, T. N., BABALUK, J. A., REIST, J. D. & VINCENT, W. F. 2012. Perfluorinated chemicals in meromictic lakes on the northern coast of Ellesmere Island, High Arctic Canada. *Arctic*, 65, 245-256.
- VESTERGREN, R., ORATA, F., BERGER, U. & COUSINS, I. T. 2013. Bioaccumulation of perfluoroalkyl acids in dairy cows in a naturally contaminated environment. *Environmental Science and Pollution Research*, 20, 7959-7969.
- WANG, F., LU, X., LI, X. Y. & SHIH, K. 2015. Effectiveness and Mechanisms of Defluorination of Perfluorinated Alkyl Substances by Calcium Compounds during Waste Thermal Treatment. *Environ Sci Technol*, 49, 5672-80.
- WANG, P., ZHANG, M., LI, Q. & LU, Y. 2021. Atmospheric diffusion of perfluoroalkyl acids emitted from fluorochemical industry and its associated health risks. *Environment International*, 146.
- WANG, Z., COUSINS, I. T., SCHERINGER, M., BUCK, R. C. & HUNGERBÜHLER, K. 2014. Global emission inventories for C4–C14 perfluoroalkyl carboxylic acid (PFCA) homologues from 1951 to 2030, Part I: production and emissions from quantifiable sources. *Environ. Int.*, 70, 62.
- WANIA, F. 2007. A global mass balance analysis of the source of perfluorocarboxylic acids in the Arctic Ocean. *Environmental Science and Technology*, 41, 4529-4535.
- WASHINGTON, J. W., RANKIN, K., LIBELO, E. L., LYNCH, D. G. & CYTERSKI, M. 2019. Determining global background soil PFAS loads and the fluorotelomer-based polymer degradation rates that can account for these loads. *Sci Total Environ*, 651, 2444-2449.
- WASHINGTON, J. W., YOO, H., ELLINGTON, J. J., JENKINS, T. M. & LIBELO, E. L. 2010. Concentrations, distribution, and persistence of perfluoroalkylates in sludge-applied soils near Decatur, Alabama, USA. *Environ Sci Technol*, 44, 8390-6.
- WEBER, A. K., BARBER, L. B., LEBLANC, D. R., SUNDERLAND, E. M. & VECITIS, C. D. 2017. Geochemical and Hydrologic Factors Controlling Subsurface Transport of Poly- and Perfluoroalkyl Substances, Cape Cod, Massachusetts. *Environmental Science and Technology*, 51, 4269-4279.
- WEI, S., CHEN, L. Q., TANIYASU, S., SO, M. K., MURPHY, M. B., YAMASHITA, N., YEUNG, L. W. Y. & LAM, P. K. S. 2007. Distribution of perfluorinated compounds in surface seawaters between Asia and Antarctica. *Marine Pollution Bulletin*, 54, 1813-1818.
- WEN, B., LI, L., ZHANG, H., MA, Y., SHAN, X. Q. & ZHANG, S. 2014a. Field study on the uptake and translocation of perfluoroalkyl acids (PFAAs) by wheat (*Triticum aestivum* L.) grown in biosolids-amended soils. *Environ Pollut*, 184, 547-54.
- WEN, B., LI, L., ZHANG, H., MA, Y., SHAN, X. Q. & ZHANG, S. 2014b. Field study on the uptake and translocation of perfluoroalkyl acids (PFAAs) by wheat (*Triticum aestivum* L.) grown in biosolids-amended soils. *Environmental Pollution*, 184, 547-554.

ANNEX XV RESTRICTION REPORT – PFAS IN FIREFIGHTING FOAMS

- WFVD & PELTZER, E. 2021. Input to the study on "REACH restriction support – PFAS in firefighting foams".
- WILHELM, M., KRAFT, M., RAUCHFUSS, K. & HOLZER, J. 2008. Assessment and management of the first German case of a contamination with perfluorinated compounds (PFC) in the Region Sauerland, North Rhine-Westphalia. *J. Toxicol. Environ. Health A*, 71, 725-733.
- WOHLIN, D. 2020. Analysis of PFAS in ash from incineration facilities from Sweden.
- WONG, F., SHOEIB, M., KATSOYIANNIS, A., ECKHARDT, S., STOHL, A., BOHLIN-NIZZETTO, P., LI, H., FELLIN, P., SU, Y. & HUNG, H. 2018. Assessing temporal trends and source regions of per- and polyfluoroalkyl substances (PFASs) in air under the Arctic Monitoring and Assessment Programme (AMAP). *Atmospheric Environment*, 172, 65-73.
- WOOD, RAMBOLL & COWI 2020. The use of PFAS and fluorine-free alternatives in fire-fighting foams.
- WU, J., MARTIN, J. W., ZHAI, Z., LU, K., LI, L., FANG, X., JIN, H., HU, J. & ZHANG, J. 2014. Airborne Trifluoroacetic Acid and Its Fraction from the Degradation of HFC-134a in Beijing, China. *Environmental Science & Technology*, 48, 3675-3681.
- WVF 2019. [GERMAN] Neue Strategien zur erfolgreichen Reinigung von PFC-belasteten Behältern, Ausrüstungen und Wässern: Saubere Lösungen.
- XIAO, F. 2017. Emerging poly- and perfluoroalkyl substances in the aquatic environment: A review of current literature. *Water Research*, 124, 482-495.
- XIAO, X., ULRICH, B. A., CHEN, B. & HIGGINS, C. P. 2017. Sorption of Poly- and Perfluoroalkyl Substances (PFASs) Relevant to Aqueous Film-Forming Foam (AFFF)-Impacted Groundwater by Biochars and Activated Carbon. *Environmental Science & Technology*, 51, 6342-6351.
- XIE, Z., WANG, Z., MAGAND, O., THOLLOT, A., EBINGHAUS, R., MI, W. & DOMMERGUE, A. 2020. Occurrence of legacy and emerging organic contaminants in snow at Dome C in the Antarctic. *Science of the Total Environment*, 741.
- XU, J., GUO, C.-S., ZHANG, Y. & MENG, W. 2014. Bioaccumulation and trophic transfer of perfluorinated compounds in a eutrophic freshwater food web. *Environmental Pollution*, 184, 254-261.
- YAMASHITA, N., KANNAN, K., TANIYASU, S., HORII, Y., OKAZAWA, T., PETRICK, G. & GAMO, T. 2004. Analysis of Perfluorinated Acids at Parts-Per-Quadrillion Levels in Seawater Using Liquid Chromatography-Tandem Mass Spectrometry. *Environmental Science & Technology*, 38, 5522-5528.
- YAMAZAKI, E., TANIYASU, S., RUAN, Y., WANG, Q., PETRICK, G., TANHUA, T., GAMO, T., WANG, X., LAM, P. K. S. & YAMASHITA, N. 2019. Vertical distribution of perfluoroalkyl substances in water columns around the Japan sea and the Mediterranean Sea. *Chemosphere*, 231, 487-494.
- YAMAZAKI, E., TANIYASU, S., WANG, X. & YAMASHITA, N. 2021. Per- and polyfluoroalkyl substances in surface water, gas and particle in open ocean and coastal environment. *Chemosphere*, 272.

ANNEX XV RESTRICTION REPORT – PFAS IN FIREFIGHTING FOAMS

- YAMAZAKI, E., YAMASHITA, N., TANIYASU, S., MIYAZAWA, Y., GAMO, T., GE, H. & KANNAN, K. 2015. Emission, Dynamics and Transport of Perfluoroalkyl Substances from Land to Ocean by the Great East Japan Earthquake in 2011. *Environmental Science & Technology*, 49, 11421-11428.
- YEUNG, L. W. Y., DASSUNCAO, C., MABURY, S., SUNDERLAND, E. M., ZHANG, X. & LOHMANN, R. 2017. Vertical profiles, sources, and transport of PFASs in the Arctic Ocean. *Environ. Sci. Technol.*, 51, 6735.
- YOUNG, C. J., FURDUI, V. I., FRANKLIN, J., KOERNER, R. M., MUIR, D. C. G. & MABURY, S. A. 2007. Perfluorinated acids in Arctic snow: New evidence for atmospheric formation. *Environ. Sci. Technol.*, 41, 3455.
- YU, N., GUO, H., YANG, J., JIN, L., WANG, X., SHI, W., ZHANG, X., YU, H. & WEI, S. 2018. Non-Target and Suspect Screening of Per- and Polyfluoroalkyl Substances in Airborne Particulate Matter in China. *Environ. Sci. Technol.*, 52, 8205.
- YU, N., WEN, H., WANG, X., YAMAZAKI, E., TANIYASU, S., YAMASHITA, N., YU, H. & WEI, S. 2020. Nontarget Discovery of Per- and Polyfluoroalkyl Substances in Atmospheric Particulate Matter and Gaseous Phase Using Cryogenic Air Sampler. *Environmental Science & Technology*, 54, 3103-3113.
- ZHAI, Z., WU, J., HU, X., LI, L., GUO, J., ZHANG, B., HU, J. & ZHANG, J. 2015. A 17-fold increase of trifluoroacetic acid in landscape waters of Beijing, China during the last decade. *Chemosphere*, 129, 110-117.
- ZHANG, M., WANG, P., LU, Y., LU, X., ZHANG, A., LIU, Z., ZHANG, Y., KHAN, K. & SARVAJAYAKESAVALU, S. 2020. Bioaccumulation and human exposure of perfluoroalkyl acids (PFAAs) in vegetables from the largest vegetable production base of China. *Environment International*, 135.
- ZHAO, S., ZHU, L., LIU, L., LIU, Z. & ZHANG, Y. 2013. Bioaccumulation of perfluoroalkyl carboxylates (PFCAs) and perfluoroalkane sulfonates (PFASs) by earthworms (*Eisenia fetida*) in soil. *Environmental Pollution*, 179, 45-52.
- ZHAO, Z., XIE, Z., MOLLER, A., STURM, R., TANG, J., ZHANG, G. & EBINGHAUS, R. 2012. Distribution and long-range transport of polyfluoroalkyl substances in the Arctic, Atlantic Ocean and Antarctic coast. *Environ. Pollut.*, 170, 71.
- ZHU, H. & KANNAN, K. 2019. Distribution and partitioning of perfluoroalkyl carboxylic acids in surface soil, plants, and earthworms at a contaminated site. *Science of the Total Environment*, 647, 954-961.
- ZOBOLI, O., CLARA, M., GABRIEL, O., SCHEFFKNECHT, C., HUMER, M., BRIELMANN, H., KULCSAR, S., TRAUTVETTER, H., KITTLAUS, S., AMANN, A., SARACEVIC, E., KRAMPE, J. & ZESSNER, M. 2019. Occurrence and levels of micropollutants across environmental and engineered compartments in Austria. *Journal of Environmental Management*, 232, 636-653.